

# Internationale Highend-Kabelhersteller und ihre technischen oder physikalischen Argumente für ihr jeweiliges Produkt-Design:

Die Quellen:

<b>Analysis-Plus:</b>	<a href="http://www.analysis-plus.com">http://www.analysis-plus.com</a>
<b>Argento:</b>	<a href="http://www.argento.dk">http://www.argento.dk</a>
<b>Audioquest:</b>	<a href="http://www.audioquest.com/">http://www.audioquest.com/</a>
<b>Cardas:</b>	<a href="http://www.cardas.com/">http://www.cardas.com/</a>
<b>Fadel Art:</b>	<a href="http://www.fadelart.com/">http://www.fadelart.com/</a>
<b>Goertz:</b>	<a href="http://www.alphacore.com/goertz.htm">http://www.alphacore.com/goertz.htm</a>
<b>Magnan:</b>	<a href="http://www.magnan.com/">http://www.magnan.com/</a>
<b>McIntosh:</b>	<a href="http://www.sundial.net/~rogerr/wire.htm">http://www.sundial.net/~rogerr/wire.htm</a>
<b>MIT:</b>	<a href="http://www.mitcables.com/">http://www.mitcables.com/</a>
<b>Mogami:</b>	<a href="http://www.mogami.com/">http://www.mogami.com/</a>
<b>Monstercable:</b>	<a href="http://www.monstercable.com/">http://www.monstercable.com/</a>
<b>Nordost:</b>	<a href="http://www.nordostuk.com/">http://www.nordostuk.com/</a>
<b>NBS:</b>	<a href="http://www.nbscables.com/">http://www.nbscables.com/</a>
<b>OCOS:</b>	<a href="http://www.klangpunkt.de/zubehoer/ocos/ocos.htm">http://www.klangpunkt.de/zubehoer/ocos/ocos.htm</a>
<b>QED:</b>	<a href="http://www.qed.co.uk/">http://www.qed.co.uk/</a>
<b>Siltech:</b>	<a href="http://www.siltechcables.com/">http://www.siltechcables.com/</a>
<b>Silveraudio:</b>	<a href="http://www.silveraudio.com">http://www.silveraudio.com</a>
<b>Soli-Core:</b>	<a href="http://www.interconnect-cables.com/loudspeaker-cables.htm">http://www.interconnect-cables.com/loudspeaker-cables.htm</a>
<b>Straightwire:</b>	<a href="http://www.straightwire.com">http://www.straightwire.com</a>
<b>Taralabs:</b>	<a href="http://www.taralabs.com/">http://www.taralabs.com/</a>
<b>Transparent:</b>	<a href="http://www.transparentcable.com/">http://www.transparentcable.com/</a>
<b>Van den Hul:</b>	<a href="http://www.vandenhul.com/">http://www.vandenhul.com/</a>
<b>Wireworld:</b>	<a href="http://www.wireworldaudio.com">http://www.wireworldaudio.com</a>

Alle aufgeführten Texte sind unveränderte Originalzitate.

Folgende Kabelhersteller lieferten keine technischen Argumente oder Begründungen auf ihrer Webseite:

**Kimber:** <http://www.kimber.com/>

Nichtkommerzielle(?) Quellen:

**TNT-Audio:** <http://www.tnt-audio.com/>

**Zeichenerklärung unserer Anmerkungen:**

**Text rot:** zweifelhafte Aussage (muß aber nicht unbedingt falsch sein, wird trotzdem skeptisch betrachtet)

**Text gelb** markiert: bemerkenswerte Aussage, stimmt mit unseren Erfahrungen überein oder ist anderswie interessant

Zusammengestellt von tmr: <http://www.tmr-audio.de>

**Weitere Quellen:**

**Gutwire:**

<http://www.gutwire.com/>

**Stealth Cable:**

<http://www.stealthcables.com/>

**Synergistic Research:**

<http://www.synergisticresearch.com/>

**The Music Cable:**

<http://www.the-music-cable.com/>

**Harmonic Technology:**

<http://www.harmonictech.com/>

**Nelson Pass:**

<http://www.passlabs.com/>

**Ecosse:**

<http://www.ecossecables.co.uk/>

**XLO :**

<http://www.xloelectric.com/>

# Cardas

## Cable Break-In

There are many factors that make cable break-in necessary and many reasons why the results vary. If you measure a new cable with a voltmeter you will see a standing voltage because good dielectrics make poor conductors. They hold a charge much like a rubbed cat's fur on a dry day. It takes a while for this charge to equalize in the cable. Better cables often take longer to break-in. The best "air dielectric" techniques, such as Teflon tube construction, have large non-conductive surfaces to hold charge, much like the cat on a dry day.

Cables that do not have time to settle, such as musical instrument and microphone cables, often use conductive dielectrics like rubber or carbonized cotton to get around the problem. This dramatically reduces microphonics and settling time, but the other dielectric characteristics of these insulators are poor and they do not qualify sonically for high-end cables. Developing non-destructive techniques for reducing and equalizing the charge in excellent dielectric is a challenge in high end cables.

The high input impedance necessary in audio equipment makes uneven dielectric charge a factor. One reason settling time takes so long is we are linking the charge with mechanical stress/strain relationships. The physical make up of a cable is changed slightly by the charge and visa versa. It is like electrically charging the cat. The physical make up of the cat is changed by the charge. It is "frizzed" and the charge makes it's hair stand on end. Cable and its dielectric also expand ever so slightly when charged, but these "Teflon cats" take longer to loose their charge and reach physical homeostasis.

The better the dielectric's insulation, the longer it takes to settle. A charge can come from simply moving the cable (Piezoelectric effect and simple friction), high voltage testing during manufacture, etc. Cable that has a standing charge is measurably more microphonic and an uneven distribution of the charge causes something akin to structural return loss in a rising impedance system. When I took steps to eliminate these problems, break-in time was reduced and the cable sounded generally better. I know Bill Low at Audioquest has also taken steps to minimize this problem.

Mechanical stress is the root of a lot of the break-in phenomenon and it is not just a factor with cables. As a rule, companies set up audition rooms at high end audio shows a couple of days ahead of time to let them break in. The first day the sound is usually bad and it is very stressful. The last day sounds great. Mechanical stress in speaker cables, speaker cabinets, **even the walls of the room**, must be relaxed in order for the system to sound its best. This is the same phenomenon we experience in musical instruments. They sound much better after they have been played. **Many musicians leave their instruments in front of a stereo that is playing to get them to warm up.** This is very effective with a new guitar. Pianos are a stress and strain nightmare. Any change, even in temperature or humidity, will degrade their sound. A precisely tuned stereo system is similar.



You never really get all the way there, you sort of keep halving the distance to zero. Some charge is always retained. It is generally in the MV range in a well settled cable. Triboelectric noise in a cable is a function of stress and retained charge, which a good cable will release with both time and use. How much time and use is dependent on the design of the cable, materials used, treatment of the conductors during manufacture, etc.

There are many small tricks and ways of dealing with the problem. Years ago, I began using Teflon tube "air dielectric" construction and the charge on the surface of the tubes became a real issue. I developed a fluid that adds a very slight conductivity to the surface of the dielectric. Treated cables actually have a better measured dissipation factor and the sound of the cables improved substantially. It had been observed in mid eighties that many cables could be improved by wiping them with a anti-static cloth. Getting something to stick to Teflon was the real challenge. We now use an anti-static fluid in all our cables and anti-static additives in the final jacketing material. This attention to charge has reduced break-in time and in general made the cable sound substantially better. This is due to the reduction of overall charge in the cable and the equalization of the distributed charge on the surface of conductor jacket.

It seems there are many infinitesimal factors that add up. Overtime you find one leads down a path to another. In short, if a dielectric surface in a cable has a high or uneven charge which dissipates with time or use, triboelectric and other noise in the cable will also reduce with time and use. This is the essence of break-in.

A note of caution. Moving a cable will, to some degree, traumatize it. The amount of disturbance is relative to the materials used, the cable's design and the amount of disturbance. Keeping a very low level signal in the cable at all times helps. At a show, where time is short, you never turn the system off. I also believe the use of degaussing sweeps, such as on the Cardas Frequency Sweep and Burn-In Record (side 1, cut 2a) helps.

A small amount of energy is retained in the stored mechanical stress of the cable. This energy blows the cable up slightly. As the cable settles back to its original shape a certain amount of the charge will be squeezed out, like in an electroscopes. This is the electromechanical connection.

Many factors relating to a cable's break-in are found in the sonic character or signature of the cable. If we look more closely at dielectrics we find a similar situation. The dielectric actually expands slightly as it is charged. This is one reason why the dissipation factor is linked to the hardness of the dielectric.

The interaction of mechanical and electrical stress/strain variables in a cable are integral with the break-in, as well as the resonance of the cable. Many of the variables are lumped into a general category called triboelectric noise. Noise is generated in a cable as a function of the variations between the components of the cable. If a cable is flexed, moved, charged, or changed in any way, it will be a while before it is relaxed again. The symmetry of the cable's construction is a big factor here. Very careful design and execution by the manufacturer helps a lot. Very straight forward designs can be greatly improved with the careful choice of materials and symmetrical construction. Audioquest has built a large and successful high-end cable company around these principals.

The basic rules for the interaction of mechanical and electrical stress/strain variables holds true, regardless of scale or medium. Cables, cats, pianos and rooms all need to relax in order to be at their best. Constant attention to physical and environmental conditions, frequent use and the degaussing of a system help it achieve and maintain a relaxed state.

A note on breaking in box speakers, a process which seems to take forever. When I want to speed up the break-in process, I place the speakers face to face, with one speaker wired out of phase and play a surf CD through them. After about a week, I place them in their normal listening position and continue the process for three more days. After that, I play a degaussing sweep a few times. Then it is just a matter of playing music and giving them time.

## **Cable Design and Construction**

Recent years have seen ferment in every area of high-end audio. Nowhere has this produced more of a revolution (controversy to match) than with audio cable. Many sizes, shapes and constructions have been tried, but as the dust has settled, a few design parameters have proven to be essential. As a result, several general approaches have prevailed. The best contemporary designs all share a good ratio of conductor resistance to cable capacitance, conductor inductance to cable capacitance and low electro-mechanical resonance. Helically wound multi-filar cables and braids now predominate. Symmetry, balance, mechanical stability and quality of materials are features that differentiate today's leading cable designs. Following is a description of the general principles, pros and cons of these designs (not discussed here are flats, tinsels, ribbons, co-axes, and certain other random or asymmetrical constructions). Electrical conductors have been made in many sizes, shapes and geometries, but over the years a definite pattern has emerged. Contemporary designs have a good ratio of conductor resistance to cable capacitance, conductor inductance to cable capacitance and low electro-mechanical resonance. Designs that do not incorporate these aspects, don't last.

Compare the different cable designs now listed in the frame on the right and read my summary or conclusions on who in high-end audio has the best designs.

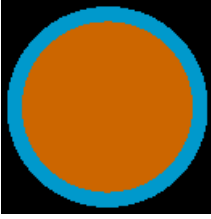

### **Solid Round**

Advantages:

1. Simple construction.
2. Low DC resistance per unit area.
3. Good resistance to capacitance ratios achievable in most embodiments.

Disadvantages:

1. High relative inductance.
2. Stiff and likely to harden with use.
3. Solid conductors tend to ring, do to low "Q".
4. High DC to AC resistance ratio.

Given the best of associated materials, single/double solid core designs represent good "values".

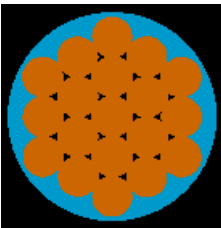

### **Bare Stranded Wire**

Basic stranded wire, "lamp cord", this is the most common wire.

Advantages:

1. Flexibility.

Disadvantages:

1. High relative inductivity.
2. Very prone to corrosion.
3. Low ring point.
4. Resonant and gritty sounding.

Not generally used or sold in high-end, it usually comes free with mass market speakers etc.

Check out the comparison between Cardas entry level cable, Crosslink, and 12 AWG. Parallel Twin with clear jacket.



### **Multi-Gauge Stranded Wire**

Advantages:

1. Slightly lower inductivity.
2. Much lower electro-mechanical resonance due to the elimination of strand multiplicity if done right (as in Kimber cables).
3. Low DC resistance for given cross-section.
4. Flexibility.
5. Works well in braided cable construction.

Disadvantages:

1. Relative inductivity still high.
2. Possible corrosion in non-Litz configurations.

Ray Kimber's multi-filar braids are state-of-the-art in this type of construction and have found a home in high-end audio. Ray's combination has advantages and has stood the test of time. These embodiments are practical, flexible, cost effective and attractive.

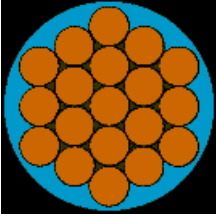

### Litz Wire

Advantages:

1. Low inductivity.
2. Coated strands don't corrode.
3. Embodiments tend to have good conductor resistance and inductance to cable capacitance ratios.

Disadvantages:

1. Resonant or wooly sound in traditional configurations due to strand multiplicity and harmonic interaction.

Litz wire has been the standard for conductors since the time of Tesla. The principals of Litz are embodied in all the successful designs. Litz in recent years has been reduced to standard stranding patterns using magnet wire in place of bare copper. This works well in RF applications, but is too resonant for present-day audio standards.

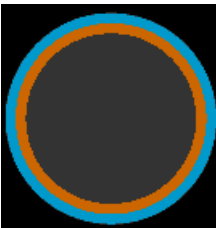

### Tubes and Tubular Stranding

Advantages:

1. Low inductivity.
2. Semi-flexible in stranded versions.

Disadvantages:

1. High resistance for a given size.
2. Tubes work by virtue of their thinness, so as an audio conductor they are limited by the fact that their resistance (and related cable capacitance) goes up as the conductor inductance goes down, giving poor resistance to capacitance ratios.

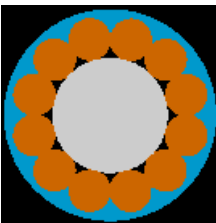

### Stranded tube

Thick-walled tubes offer little advantage over solid core and thin walled tubes collapse. Stranded tubes have seen some success: Bill Low's Hyperlitz is a unique example. Of the solid tubes, only Cogan-Hall's very simple and clever connectorless design seems to have survived. I would have to say that it is the reference standard for tubes.

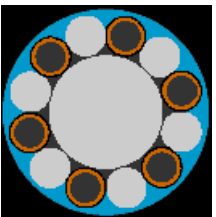

### Hyperlitz

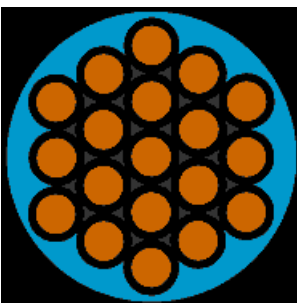

### Parallel Multi Solid Core

Advantages:

1. Lower inductivity.

Disadvantages:

1. Design is limited by high dielectric involvement, bulk, difficulty holding symmetry as the number of strands increases.
2. Higher resistance for given size construction.

The simplest of constructions have found some success in the interconnects, and some of the very small speaker cables (Audioquest, Space and Time). Rodger Skoff's counter-helically wound XLO interconnect is a classic example of this type of construction.



**Constant 'Q' Stranding (Golden Section)**

Advantages:

1. Lowest inductively for given size.
2. Low resistance for given size.
3. Very high Q (L/R) in both conductor and embodiments of the conductor.
4. Compact very low energy storage and characteristics and flexible.
5. Virtually eliminates electromechanical resonance.
6. Very low polar moment - conductor field interaction is dramatically reduced.
7. Stored energy is almost eliminated allowing direct transfer cables to be produced.
8. Coated strands eliminate corrosion.

Disadvantages:

1. Labor and time intensive construction.
2. Rather costly.

This construction is patented by Cardas Audio, and requires no hype on my part. It is obviously (in my mind) the best of conductor design.

## Cable Design and Construction Conclusion

It is easy to see that Ray Kimber, Bill Low, Rodger Skoff and myself have arrived at similar formulas from diverse paths, our common use of multiple parallel conductors and multi-filar constructions is the most obvious common element. The electrical similarity is less obvious. If you measure the capacitance of each of our cables, they are all about the same, 45 pF per foot (= 148 pF/m) more or less. In fact, the standard super-market give-away cable is within that same range. The difference is the inductance and resistance of our conductors. Capacitance by itself means little unless viewed in the light of conductor inductance and resistance. High-end cables as a whole lower conductor resistance and inductance without increasing capacitance. Even less obvious to the eye, but most obvious to the ear, is the degree to which conductor resonance is reduced by various geometries.

In retrospect I think we should credit those who long ago understood and incorporated these ideas. Not counting Nikola Tesla, who seemed to have everything figured out even before stereo was born, I have to pay tribute to Alex Gibson of Family Music Systems as the great un-heralded pioneer of cable design.

There is more to cable design than the simple perspective outlined here. Many improvements are still to be realized. However, I believe we have arrived at some basic principles. **The two real options for cabling the conductor are obvious (multi-filar helical and multi-filar braid).** I believe high purity copper to be the best conductor. I will say that there are a few un-revealed secrets in the department of characteristic impedance, and I will admit to the possibility of a dynamic symmetry in the works, but these and other designs will have to wait for their day.



## Soldered vs. Crimped Connections

When we look at crimping connectors onto cable vs soldering them, I would have say that most crimped connections are better than most soldered connections. However, the best connections are soldered connections. The problem is there is only one type of solder connection that is truly a joint, most are as the word states, a connection. Most solders, such as the popular 60/40, are a slurried mixture of tin and lead. In making the joint the tin/lead mixture melts, but as it solidifies it does so one metal at a time. It goes into a slurry state and one metal is liquid and the other is very small solid particles, sort of like wet cement. Next, the other metal solidifies and creates a million little connections. This type of connection is not particularly good and not permanent. When the phone company that had to use this type of solder on their main frames, every joint had to be reheated once a year to insure reliability. Even then, the "cold joint" was a common occurrence. Bad and noisy joints were the main cause of failure in early printed circuit boards and electronic equipment until some time in the mid sixties or early seventies. Then they learned that eutectic joints were perfectly reliable and I do mean perfectly. By the mid seventies or early eighties most electronic equipment was being soldered with eutectic solder (63/37). The reliability of printed circuit boards went up about 1000% and solid state audio gear began to sound almost tolerable. Today, all printed circuit boards use 63/37 eutectic solder. Eutectic solder is a special mixture. The melting point of a eutectic solder is lower than any of its component parts, so there is no slurry state in these solders. They solidify as one piece and make a true solder joint, not a connection. Now, provided that the parts being soldered are made of the metal incorporated in the solder (tin plate in the example of printed circuit boards and component leads, with 63/37 tin/lead eutectic solder in the solder baths), you will have a perfect joint.

These quality joints are easy to see. Most solders are very shiny when molten and get a haze on their surface as they solidify. Eutectic joints are shiny all the way to the metal being soldered, if the metal being soldered is of the same parent group as any of the components of the solder. Many of the connectors I use are plated silver with a rhodium flash. The only wires used in high end audio are copper and silver, so I developed a tin/lead/silver/copper eutectic or Quadeutectic solder. I have never had, or heard of, a single failure in one of these joints. This solder is now used in the vast majority of all high end cables and equipment. Properly done, Quadeutectic joints provide the best sound with the lowest noise and contact resistance; all with absolute reliability.

We supply Quadeutectic solder in many sizes, with either activated rosin core or organic water base flux. Activated rosin flux is ideal for most applications where the components are not washed after soldering. The rosin is actually a protective coating. The organic water based flux must be washed from the component after it is soldered. Manufactures of boards sometimes use the organic flux to get a really clean look to their boards, however, they must be washed carefully after soldering to prevent corrosion. I recommend the use of the rosin core solders for most applications.



## Golden Reference Speaker Cable



Golden Reference speaker is the latest evolutionary speaker cable design by George Cardas. It features Cardas patented "Golden Section", multi-gauge stranding in a symmetrical, 12 conductor, helical triad of quad-axial planetary arrays of golden ratio, constant Q conductors.

Cardas patented, "Constant-Q" construction places the smallest of the Golden Ratio strands at the center of the conductor to reduce stored energy and conductor resonance. Cable resonance is further reduced with controlled propagation, Crossfield construction, matching conductor and cable loop characteristics with carefully computed strand layering. Cross layered conductors reduce EMI and RFI to a new low. All conductors are individually coated to insulate and prevent oxidation.

Golden Reference is a perfectly neutral reference cable with unmatched transient purity. Golden Reference is perfectly symmetrical and non directional. Like all Cardas cable, Golden Reference is individually inspected, and hand terminated using Rhodium plated connectors and Cardas formulated Quad Eutectic solder, for a lifetime of listening pleasure.

### Specifications:

Outside Diameter:	702
Dielectric Type:	Teflon=C6, Air
RCA Capacitance pf/ft:	36.9 = 121 pF/m
Inductance $\mu$ h/ft/loop:	.0031 = 0,102 $\mu$ H/m
Discrete Conductors:	68
Cable AWG:	5
Resistance:	10kHz ~ .00079 $\Omega$ /ft., 100 Hz ~ .00076 $\Omega$ /ft. = 2.6 m $\Omega$ /m
Internal Bi/Tri-Wire Options:	Bi/Tri
Conductor Type:	Matched propagation, Golden Ratio, Constant Q, Crossfield, Pure Copper, Litz

## Neutral Reference Speaker Cable



Cardas Neutral Reference speaker is designed as a perfectly neutral reference cable. It sounds the same at any length, whether one or thirty feet, between any component, at any originating or terminating impedance. Neutral Reference is perfectly symmetrical and non-directional. It can be terminated either single or bi-wired.

### Specifications:

Outside Diameter:	.600" = 15.2 mm
Dielectric Type:	Teflon, Air
Inductance $\mu\text{H}/\text{ft}/\text{loop}$ :	.034 = 0.01 $\mu\text{H}/\text{m}/\text{loop}$
Capacitance pF/ft:	117 = 384 pF/m
Cable AWG:	8.5
Internal Bi/Tri-Wire Options:	Bi
Conductor Type:	Golden Ratio, Constant Q, Crossfield, Pure Copper, Litz.

### Speaker Cable Selection Guide by George Cardas

There are many reasons for differences in speaker cables. Some, like microphonics, are hard to quantify in lay terms. Others, like AC resistance and loop inductance, are easier to see. For comparison, I have chosen our top of the line speaker cable - Golden Cross - and our entry level cable - Crosslink. I have also taken three common but extreme examples - RS 28 gauge "speaker cable", RS "Mega Cable" and a Pep Boys 8 AWG jumper cable - to illustrate how high-end cables reduce both resistance and inductance to increase timely signal transfer and reduce inductance related distortion.

	Cable AC loop resistance in ohms			Cable AC loop inductance in $\mu$ henrys
	100~	1k	10k	
Golden Cross	.018	.018	.019	.36
Crosslink	.046	.046	.048	1.1
Pep Boys 8g	.014	.0153	.0206	2.5
RS 28spk	458	.500	.500	2.4
RS Mega	.084	.084	.087	2.6

All samples are 10ft in length.

The main objective of a speaker cable is to achieve maximum current transfer with minimum distortion. The main elements involved are resistance and inductance. The problem is achieving low inductance and low resistance, because as you make conductors larger the resistance goes down but the inductance time delayed information and low level distortion go up. As you can see from the information below, keeping a low and constant resistance and inductance is a strong point of our high-end speaker cables.

Resistance and its relationship to inductance and capacitance ("Q" factor) is one key to interconnect performance as well. Lower resistance, high "Q" conductors are desirable.

	"Q" factor	
	10K AC resistance ohms	Q 10k
Freebie	.52	.45
Golden Cross	.022	3.9
Cross	.03	4.3

# TARALABS

The Most Important Component in Your Audio or Home Theater System...

Is it the video Processor?

The television?

How about the DVD player?

Actually, using the right cables in your home theater will do more to enhance the performance of your system than anything else.

Cables, after all, carry the audio and video signals from component to component in your system. How efficiently they do their job, without loss or distortion from outside interference, directly affects the clarity, brilliance and power of the sound and picture in your home theater.

Replacing the cables that came in the box with quality TARA Labs cables can enhance your home theater experience by:

## 1. Rejecting outside interference



A properly designed and shielded cable is your best defense against RFI and EMI (Radio Frequency and Electromagnetic Interference.) These wave forms are created by appliances, phones, digital equipment, even your home theater components themselves, and they are everywhere. RFI/EMI can result in grainy “grungy” sound and picture abnormalities like color shift or “snow.”

TARA Labs cables use the highest grade copper foil and copper braided Shielding; some are double shielded for use in areas of high RFI/EMI or in longer runs. In some cases, the design of the cable works to reject RFI/EMI, using the principle of “Common Mode Rejection”.

## 2. Providing a clear signal path

The type of conductor used in a cable is an important factor in its ability to pass a signal without loss or distortion. **Solid core conductors have distinct advantage over stranded or braided cables.** Stranded cables oxidize quickly because of the tiny air spaces between the fine strands of the conductor. Oxidation creates electrical irregularities in the conductor where high frequency signals cannot pass easily. Oxidation in the conductor shows up in the sound as noise and distortion, and can cause a loss of sharpness or color definition in the picture.

TARA Labs cables use either solid core conductors or a proprietary type of conductor called “Pressure-Stranded”. Pressure-Stranded conductors are bundled together under pressures several times higher than the average stranded conductor, eliminating the air spaces that would otherwise cause oxidation. Our Rectangular Solid Core cables have a special solid core conductor with a rectangular cross section. This not only eliminates the effects of oxidation, but the shape itself is ideal for signal transfer with no loss or distortion of high frequencies.

### 3. Eliminating the effects of Dielectric distortion

Every cable uses some form of Dielectric, the technical name for the insulation materials that give the cable structure and keep the conductors separated. There are many types of Dielectric materials, mostly made of fiber or some type of polymer plastic. Unfortunately, every material that has proper insulative qualities also has a certain amount of reactivity with the electrical signal. They tend to absorb the signal as it passes through the conductor, and release it again out of phase with the original signal. This results in a loss of clarity in the audio signal and distortion of the video signal.

TARA Labs' Aero-PE insulation is chemically treated to be less reactive than any other type of material normally used as cable Dielectric. TARA Labs also has the only cables in the world to use our proprietary Airtube. In the RSC Air Series cables, the conductors are suspended within separate chambers inside a central air-tube. This eliminates any Dielectric distortion and results in sound that is clean, clear and natural.

## TARALABS - The Science of Cable Design Part I

### Measuring Cable Performance & Correlating Results with the Listening Experience

There is an increased awareness among audiophiles as to the importance of cables in the sound of an audio system. It is a subject that has been surrounded by controversy, in part because many feel the differences to be either too subtle to be audible, or too system-dependent to hold any universal truth for buyers of audio equipment.

In fact, it is possible to make measurements of different audio cable conductor designs that will correlate with audible differences in the cables' performance. Moreover, with these measurements as a learning tool, one can begin to distinguish conductor designs which are linear and accurate as opposed to designs which soften, brighten or otherwise color the sound.

- (1) = 1 x 2 mm<sup>2</sup> round
- (2) = 2 x 1 mm<sup>2</sup> round
- (3) = 2 x 1 mm<sup>2</sup> rectangular

In 1988 TARA Labs developed Constant Current Impedance Testing (CCZT), a testing method which has been used in advanced university engineering studies to measure cable performance. These measurements provide reliable predictions about the sound to be heard from the changes of cable conductor design and configuration. With CCZT, we have been able to reliably and repeatably correlate the listening experience to the test-bench experience.

---

### Constant Current Impedance Testing

- A. = Signal Source
- B. = Signal level Control
- C. = Amplifier
- D. = Current Limiting Resistor
- E. = Calibration Resistor
- F. = R<sub>(Z)</sub> to be measured

---

CCZT measures impedance vs. frequency or linearity with frequency. This is both a necessary and important criterion of cable performance because it directly relates to rise time and phase coherency. These two elements, more than any other, correlate directly to one's perception of a cable's sound as either "live," or reproduced.

In CCZT testing we use conductor runs of equal mass (i.e. same D.C. resistance) but varying conductor shape and arrangement. They are set up in a test jig having the same parallel configuration between the send and return lines. This methodology accurately compares the design qualities of the conductors themselves while keeping all other factors identical.

The results of the tests are shown in the graph. Listening tests of the cables generate results as might be expected from examination of the graph.

Single 2 mm (14 gauge) round conductor: Upper bass and mid-range are warm. Treble is soft and rolled off.

Two 1 mm (14 gauge) round conductors: Upper bass and mid-range are cleaner, with better definition. Sound is more natural and coherent. Less roll-off in high frequencies.

Two 1 mm (14 gauge) rectangular conductors: Upper bass and mid-range are more vivid, palpable and live sounding. The sound through the mid treble and upper frequencies is extremely coherent and natural. Overall, the natural harmonic structure of the music is more accurately revealed.

With even a rudimentary understanding of the principles of cable design it's possible to make good predictions about the sound of a cable just by examining its internal structure.

## **TARALABS - The Science of Cable Design Part II**

### **How Conductor Size and Shape Affect Performance; What to Look for**

---

#### Constant Current Impedance Testing

- (1) = 1 x 2 mm<sup>2</sup> round
  - (2) = 2 x 1 mm<sup>2</sup> round
  - (3) = 2 x 1 mm<sup>2</sup> rectangular
- 

In Part I, we measured the frequency linearity of various cable designs using TARA Labs' Constant Current Impedance Testing (CCZT).

Why do different conductor types of the same mass yield such different results? In a few words: electromagnetic flux linkage.

Referring to the graph of the CCZT results, we see that the single 2 mm<sup>2</sup> (14 gauge) conductor shows the least linearity with frequency. This is because in a larger single conductor there is more electromagnetic flux, which increases in density towards the center of the conductor. This crowding, or density of the electromagnetic lines of force at the center of the conductor effectively chokes off higher frequencies and forces them to travel towards the outside of the conductor.

Any compact or uniform shape increases the tendency of the whole conductor to have greater density in the coupling or linkage of electro-magnetic flux. In this diagram, a stranded conductor shows the same tendency to roll off high frequencies as a single solid conductor of the same mass.

An important note: this is true whether the conductor is a single solid-core or a stranded conductor of the same conductive mass or DC resistance. A large diameter conductor, whether solid-core or stranded, will have the same impedance vs. frequency curve for a given diameter and mass. In other words, the closely bundled small conductors in a multi-strand conductor approximate a single large solid-core conductor, so nothing is gained by stranding many smaller conductors.

In the second trace, we have split the single conductor into two smaller ones. Combined, they have the same mass, but the frequency linearity is improved because of their smaller individual diameters and lower electromagnetic flux linkage. Although the conductors are subject to flux linkage because of proximity, they have the greater frequency linearity that goes with a smaller diameter. This is the principle behind many of TARA Labs' Prism Series solid-core cable designs.

In the third trace, the Rectangular Solid Core conductors still have the same mass but their frequency linearity is improved further. This is because the rectangular conductor has less coupling of electromagnetic flux at the center of the conductor. Due to its shape, there is effectively no "center" to speak of.

What to look for, then, when choosing cables? A design with thinner conductors in a more open configuration will yield cleaner, clearer and more frequency-linear sound. One with a single, large conductor or a bundle of smaller conductors will yield sound that is smoother and rolled off.

All designs have the same conductive mass, but frequency linearity (i.e. a cleaner, clearer sound) will improve from left to right due to conductor size, shape & arrangement.

These guidelines hold true regardless of variations on these design themes and account for most of an audio cable's sound. Other elements, such as dielectric and conductor material and treatments, are the icing on the cake of cable design, having a lesser effect on cable performance than good, solid design principles.

## **TARALABS - The Science of Cable Design**

### **Part III**

#### **The Sonic Differences Between Conductor and Dielectric Materials and Treatments.**

In Part II, we discussed the conductor's own inductive reactance and its effect on the sound in an audio cable. In this installment, we'll examine conductor materials and treatments, as well as dielectric materials and their effect on the sound. Although it's important to note that these factors have a lesser effect on the sound than the design of the conductors themselves, when the conductor is more linear with frequency, these minor differences in materials do become more apparent.

-----  
Conductor diameter vs. frequency linearity

D = Diameter of conductor  
 $\mu$  = Permeability of material  
f = Frequency at which HF attenuation occurs  
 $\rho$  = Specific resistivity of material ( $\mu\Omega/\text{cm}$ )

-----

The two most common conductor materials today are copper and silver. Is one inherently better than the other? Not necessarily. So much depends on the purity and treatment of the raw conductor material. The treatment process known as annealing softens and purifies the conductor material, affecting its specific resistivity. Proper annealing of copper conductors increases conductivity (lowers specific resistivity) by increasing the length and size of the crystals within the material. This results in fewer electrical discontinuities in the conductor, removing the distortion, brightness, or hashiness from the sound.

Conductors must also be properly designed to deliver maximum frequency linearity with any given material. The mathematical formula shown above shows a direct relationship between the diameter of the conductor and the specific resistivity of the material. We see that, for a given conductor material, there are different frequency response curves and different linearity with frequency. The sound of a properly designed and treated conductor is open, neutral and extended, yet smooth and without grain. Conductors which sound harsh or bright have not been properly designed, or treated, or both.

Insulating materials exposed to electric fields are called "dielectrics." Dielectrics are necessary components in any cable because they prevent oxidation and keep the conductors from touching one another. In audio cables, relatively low voltage and current levels mean that dielectric strength is not the most important factor. Far more significant in its effect on the sound is a material's dielectric absorption. This characteristic describes the way a dielectric may discharge a secondary signal into the conductor out of phase with the audio signal.

As a current is passed through a conductor, an electromagnetic field is created which interacts with the dielectric material and temporarily displaces the molecular structure. **If the dielectric material has good elasticity and can return quickly to its normal state, then the material is said to have low dielectric hysteresis or loss and will have little audible effect on the signal.**

Dielectric materials, then, sound different because of the different rates that the materials store and release energy at different frequencies. **PVC, a common dielectric material, causes distortion and coloration mostly audible in the mid-bass and mid-range frequencies, whereas Teflon causes distortion in the lower treble frequencies, making coloration less noticeable.**

TARA Labs uses a proprietary dielectric material called "Aerospace Polyethylene" or "Aero-PE." This material is chemically treated to have low dielectric absorption and high dielectric elasticity. Therefore, it reacts less and returns more quickly to its neutral state, making it more sonically neutral than other materials. Aero-PE is also extruded at a lower temperature than other insulating materials. Copper conductors insulated with Aero-PE are not exposed to high heat and therefore retain their specially annealed qualities.

---

Audio signal creates an electro-magnetic field around the conductor.  
Dielectric materials absorb energy and release it back into the conductor out of phase with the audio signal.

---

**In comparing lesser quality cables, you may never hear the difference between PVC and PE insulation, or hyper-pure vs. low grade copper. The limitations of the design itself will obscure these subtler effects. However, with high-quality cable designs, one can more readily hear the differences in materials, proper annealing and good quality insulation.**

## **TARALABS - The Science of Cable Design Part IV**

### **The Audio Cable as Low-Pass Filter and its Role in the Pursuit of Neutrality**

In the last three installments, we examined the aspects of cable design which have the greatest effect on performance: conductor design and arrangement, and dielectric design and materials. We also showed how the differences between cables can be measured and correlated with the listening experience.

In this installment we'll discuss the cable as a second-order low-pass filter and examine the subject of neutrality in an audio cable.

With its series inductance and parallel capacitance, an audio cable is a simple second-order low-pass filter. By reducing the inductance and capacitance, we can increase the bandwidth of the cable and extend the cable's frequency response.

Within its frequency response an audio cables' capacitance remains fairly constant with frequency, but the inductance in the cable varies with frequency. This is due to the inductance being dependent on the diameter (or shape) of the conductors and the configuration of the conductors within the cable. These changes in inductance cause audible differences which will be different with different component output/input impedances. When the electromagnetic field (inductance), which varies with frequency, interacts with the electrostatic field (capacitance), this causes different electrical resonances and filtering effects within the cable interface. Depending on the diameter and configuration of the conductors within the cable, the amount of inductance will vary considerably and the sound will be audibly affected.

In Part II, we examined how to reduce the series inductance by having smaller conductors, and having them in a more open arrangement. **To reduce the parallel capacitance it is simply necessary to space the positive and negative conductor runs further apart.** Increasing the cable's bandwidth in this way improves the cable's linearity with frequency and ensures less system interaction because of the reduced electrical characteristics of the cable. 

The ideal audio cable then, has low series inductance (smaller conductors or rectangular ones with less inductive reactance) and low parallel capacitance. In this way it has very high bandwidth and is then less system dependent.

The reduced system interaction of the cable created by increased bandwidth will yield an important quality we call neutrality. Most would agree that the ultimate system is one which brings us as close to the experience of the original musical event - whether that was in a studio or a live concert setting. We want to hear the music as it was recorded: nothing left out, nothing added. Neutrality then, not alteration or coloration is an important quality in audio cable performance.

Cables are the only component within an audio system that can be designed to be completely neutral. Every other component, by its very nature, alters the signal in some way. The theoretical ideal of an audio cable is one with zero series inductance and zero parallel capacitance. In this way the cable has unlimited bandwidth and is also not system dependent. TARA Labs cables, designed against this theoretical ideal, are designed to have the lowest LCR specs and widest bandwidth on the market.

If neutrality in your audio system is important to you, begin to narrow down your cable choices by starting with those that have the lowest LCR specs. (Any reputable manufacturer should be able to supply these figures and to explain the method by which they were obtained.) Then use educated listening techniques to determine which of the cables sounds best in your system.

This philosophy, by the way, is not universally endorsed by cable manufacturers. There are other cables on the market which are designed to act as "tone controls" for the system. They use networks, filters or additional elements that are meant to somehow improve the audio signal by altering it. In fact, these do nothing more than impose upon the system someone else's idea about how the music should sound. The result is contrived and artificial, rather than transparent and neutral. Above all, it will most likely produce colorations that destroy the natural, musical reproduction you've tried so hard to create.

Achieving complete neutrality in an audio system may be an impossible dream. After all, we are reproducing a musical event, not experiencing the "real thing." But the pursuit of this ideal is a worthy one, primarily because it puts the emphasis where it belongs: on the music.

## **TARALABS - Constant Current Impedance Testing (CCZT) for the measurement of audio cable performance**

The purpose of this white paper is to explain the methodology and scientific principles supporting Constant Current Impedance Testing (CCZT). This proprietary testing method, devised by TARA Labs' Research and Testing Department, is used to measure the differences in cable performance. CCZT highlights the fundamental and primary reason that audio cables sound different, and that is the design (size, shape and configuration) of the conductors themselves



We can make measurements of different audio cable conductor designs and find that the measurements will correlate with the differences that we can hear. Moreover, with the measurements as a learning tool, we can begin to distinguish conductor designs that are linear and accurate as opposed to designs which soften or color the sound. With sine wave analysis, using a frequency generator and oscilloscope, we can make measurements that will provide reliable predictions about the sound to be heard from the changes of cable conductor design and configuration. At TARA Labs, we have been able to reliably correlate the listening experience to the test-bench experience by developing certain tests described later in this white paper.

The fundamental differences between cable designs have to do with two basic criteria: conductor size and conductor shape. **In a conductor with a smaller diameter, the current carrying capability is reduced but linearity with frequency is improved.** Linearity here is defined as the least degree of impedance rising with increasing frequency. It is both necessary and important because it directly relates to correct harmonic structure, phase coherency, rise-time and the accurate reproduction of the musical signal. As well as the size or diameter, the shape of a conductor (round, rectangular) can change its linearity also.

We can compare the rising impedance with increasing frequency for different conductors of different sizes and different shape. The self-inductive related rising impedance of the conductors, sometimes referred to as the 'skin-effect', is a phenomenon that can be measured down to as low as @1 kHz with TARA Labs' Constant Current Impedance Testing (CCZT) setup. With these measurements, we have found that for any given conductor, the measured impedance from DC to 1 kHz is the same as the DC resistance of the conductor. At around 1 kHz and above, a conductor will have a rising impedance vs. frequency response. When we compare these responses above 1kHz, as well as noting the phase shift in the different conductors at varying frequency, we can draw conclusions about the sound to be heard from these conductors as used alone or as part of a finished cable design.

In the following tests, we use conductors of equivalent mass, but of differing shapes. The conductors are placed through a Test-Jig constructed of MDF. The conductors form a 10-foot channel run and have the same parallel configuration between the send and return lines. This methodology is valid because it accurately compares the design qualities of the conductors themselves while keeping all other factors identical.

For the sake of brevity, the test results from our Test-Jig and Frequency Generator set-up are shown for 5k and 10k. See "Measurement Summary" to note the measured differences. Then see the graphed results of the four main conductor types after their results were tabled and plotted.

Starting with the 14 AWG round conductor, we note that it has the least linearity with frequency. This conductor could be stranded or solid, but even if you assume the best case for the stranded conductor, i.e.: that it had no oxidation between the strands, then the conductor whether stranded or solid will have the same impedance vs. frequency curve for a given diameter and mass. Multiple-stranding does not mitigate the skin effect when the strands are bundled together as one conductor. The skin effect or inductive reactance will be the same for a stranded or solid conductor of the same diameter and conductive mass.

The inductive reactance and the skin effect are reduced when the strands are separately insulated from each other. This leads to Litz-Wire (multiple enamelled wire) construction such as is used in some high-end cable. Look at the entry marked 4 x 20 AWG Enamelled, equivalent to a 14 AWG conductor. This conductor has superior linearity compared to the 14 AWG round conductor. Its linearity is due to smaller size wires being used. But because the construction is 'compact' and not spaced apart, it nonetheless approximates a round conductor in its overall shape. Any compact or uniform shape increases the tendency of the whole conductor to have greater density in the coupling or linkage of electro-magnetic flux, thereby reducing the high frequency linearity. See the notes on 'skin-effect' for a complete explanation.

Next, note the conductor made of two round solid wires whose mass together is equivalent to 14 AWG. This conductor has slightly better linearity than the 4 x 20 AWG Enamelled wire conductor even though the individual gauge size of each of the two solid wires is greater than 18 AWG. The reason is that this conductor construction has less coupling or flux linkage between the two solid wires due to their spacing and overall shape. This is an important point and leads us to make conclusions about compactness in multi-solid core conductor designs. Spacing conductors apart increases linearity. Compactness in a design reduces linearity. Finally, the rectangular conductor is inherently more linear than any of the round conductor types due to its shape and diminished flux linkage.

## The sound

(1) 14 AWG Round conductor.

The highs are definitely softened and rolled off. The mid-range and upper bass are warm and colored, and the bass is full but not distinct or clear.

(2) 4 x 20 AWG Solid Enamelled conductor.

The sound is more linear; the highs are a little soft and dark sounding. The mid-range and upper bass are more natural sounding, though slightly warm or colored. The mid-bass and bass are cleaner and clearer sounding than the 14 AWG Round.

(3) 2 x Round Solid conductor.

The sound is linear and natural; the highs are softened slightly. The upper mid-range, mid-range and upper bass are coherent, clear and natural. The mid-bass is less distinct or clear than the 4 x 20 AWG but cleaner and clearer than the 14 AWG Round.

(4) 2 x Rectangular conductor.

The sound is remarkably different. The highs are extended and clear. The upper mid-range, mid-range and upper bass are clear, natural and very coherent. The natural harmonic structure of the music is very apparent. By comparison to the other conductor types, every aspect of the mid-bass and bass is perfectly distinct and clear.

### Notes on Skin Effect:

The phenomenon known as the "Skin Effect" (higher frequencies tend to travel toward the skin of the conductor) causes high frequencies to be attenuated as compared to lower frequencies, which travel more uniformly within the conductor. For any conductor with a uniform diameter or uniform thickness, there will be more coupling or linkage of electromagnetic flux at the center of the conductor as compared to the surface. As a result, there will be more opposition to AC current at the center of the conductor. Also, as the AC frequency increases, there will be an increasing rate of change of flux. This causes increasing counter-EMF to be generated nearer the center of the conductor, reducing HF energy as frequency increases. The conductor can be compared to a series inductor: the high frequencies are attenuated more and more as the diameter or thickness of the conductor increases and as frequency increases also.

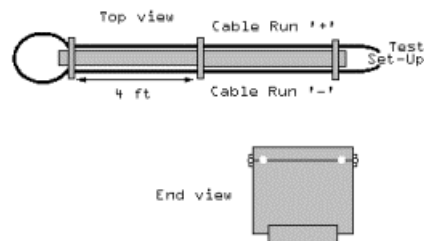
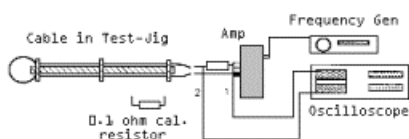

### Constant Current Impedance Testing (CCZT)

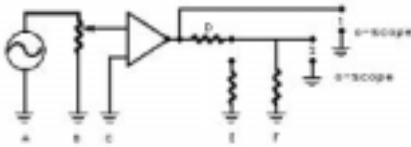

A = Signal Source  
D = Current Limiting Resistor

B = Signal Level Control  
E = Calibration Resistor

C = Amplifier  
F =  $R_{(Z)}$  to be measured

If Resistor D is expected to be much larger than Resistor E, and higher than Resistor F will be over the entire frequency range, then the current passing through  $R_D$  and  $R_E$  is largely determined by  $R_D$ .

For example, let us say that  $R_D = 1000 \Omega$  and  $R_E = 1 \Omega$  and the expected resistance of  $R_F$  is about  $1 \Omega$ .

Changes in  $R_F$  or  $Z_F$  resulting from changing the input frequency will have little (about 1%) effect on the current in the circuit. Therefore, the voltage across  $R_E$  (calibration) or  $R_F$  (impedance to be measured) will be proportional to the impedance of  $R_E$  (or  $R_F$ ).

### Constant Current Impedance Testing (CCZT)

#### Procedure -- Conditions

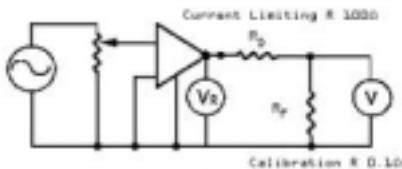

Connect resistors as shown.

AC voltmeter or Oscilloscope is connected at V.

Signal source (frequency generator) is set at desired frequency. For all practical purposes, measurements of Z in wire or cable are the same from DC to about 1 kHz. Signal level control is adjusted until meter or scope reads at 1 division, preferably 1/10 full scale. The sensitivity will need to be high due to 1/1000 voltage division of circuit. After the 1 division deflection is made, do not adjust the signal level or scope sensitivity.

Substitute Resistor  $R_F$  or cable to be tested for the calibration resistor, after the meter or scope has been calibrated. The number or division of the deflection on the meter or scope will be proportional to the resistor  $R_F$  or the cable under test and read as the impedance at the input frequency.

NOTE: Phase shift can be seen with a dual trace scope by connecting the other channel at  $V_R$ . The shift in phase of the sine wave traces will be that caused by the capacitive or inductive reactance of the cable under test  $R_F$ .

## Measurement Summary

Diagramm	Area	Type	Z( $\Omega$ ) @ 5 kHz	Z( $\Omega$ ) @ 10 kHz
1a	14 WG	Solid Core	0.19	0.39
1b	14 WG	Stranded	0.20	0.41
2	14 WG	2x Round Solid Core, PE insulated	0.16	0.31
3	14 WG	4x Round Solid Core enamelled	0.16	0.33
4	14 WG	2x Rectangular Solid Core, PE insulated	0.14	0.28

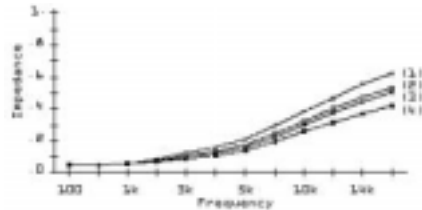

1.a



1.b



2.



3.



4.

## TARALABS - The One Series Cables

TARA Labs, innovators in audio and video cable design, introduced a new flagship series of products in the spring of 1997. The One Analog Interconnect, Digital Interconnect and Speaker Cable were designed to be the most transparent, neutral and musically accurate cables in the world. Several proprietary, new technologies converge with more established innovations engineered by TARA Labs. This paper will provide an examination of the scientific approach behind the materials, design and manufacture of these cables.

### Rectangular Solid Core Technology

In 1991, TARA Labs introduced a technology that would set new standards for cable performance. Rectangular Solid Core (RSC) designs were based on the use of solid, extruded conductors with a rectangular cross section. The various cables produced by TARA Labs using this conductor have been proven to be the most frequency linear on the market. In addition to being the most reviewer-owned cables in the world, RSC cables have become top sellers in the high-end audio market and received critical acclaim from the audiophile press all over the world.

The One cables all employ Rectangular Solid Core designs which have been refined to deliver a musical signal that is even more neutral, transparent, and natural than before. The conductors themselves are RSC Generation 2 conductors made of Consonant Alloy, a proprietary alloy from TARA Labs which is more conductive than the purest form of copper alone.

Even more significant than the material itself is the way the conductors are handled during extrusion and annealing. RSC conductors are polished in-line, before the primary insulation is applied, giving them a microscopically smooth, mirror-like finish. This process enables the insulation to adhere evenly.

Otherwise, gaps or tiny air spaces between the insulation and the conductor could create distortion of high frequencies due to different dielectric hysteresis of air vs. plastic materials.



In addition to Consonant Alloy, The One cables employ a number of other proprietary materials, each chosen for their specific sonic qualities.

### **Glass Microsphere Insulation: the Next Best Thing to a Vacuum**

In most cables, insulation materials have seemingly little effect on sound quality. Because most cable designs are inherently flawed to begin with, noisy and distortive, the subtler effects of dielectric absorption may not be noticed. In cables offering superb resolution such as The One, insulating materials have a more significant effect on the sound because more is revealed in the signal.

The insulation used in The One is another proprietary technology from TARA Labs. It consists of chemically stabilized Polyethylene (Aero-PE) which has been modified by the addition of vacuum-filled, microscopic glass spheres. These spheres, created in a vacuum chamber, provide a dielectric environment which is optimal due to its lack of dielectric absorption. To understand why this is so, it's necessary to understand a few basics about the nature of dielectrics.

As a current is passed through a conductor, an electromagnetic field is created which interacts with the dielectric material and temporarily displaces its molecular structure. If the dielectric material reacts slowly to this process, a secondary signal can be discharged into the conductor out of phase with the audio signal. If the dielectric material can return quickly to its normal state, then the material is said to have low dielectric hysteresis or loss and will have little audible effect on the signal.

Acting as a wave guide, a conductor will transmit its signal best in a vacuum (second best in air) because all other materials suffer from some level of dielectric absorption. Of course, suspension of a conductor in a vacuum-filled environment is only a theoretical possibility at this point. The vacuum-filled glass microspheres in this new insulation material come closest to approximating this condition, providing the lowest dielectric involvement of any material currently in use.

### **The One Analog and Digital Interconnects**

The One Analog Interconnect employs two individually insulated RSC Generation 2 conductors helixed around a Teflon airtube dielectric. Multiple layers of Teflon tape displace the conductors from the shield, reducing the cable's capacitance. A unique Isolated Floating Shield, which will be described in greater detail shortly, and **composite monofilament anti-static braid complete the design.**

The One Digital Interconnect is a strict 75  $\Omega$  impedance coaxial design using the same high quality materials as the analog version.

Both are equipped with specially designed TARA Labs locking RCA plugs and Resonance Diffusor Barrels, which are made from the same aerospace-grade aluminum alloy used in aircraft and spacecraft construction. When used in constrained layer damping applications in aerospace studies, this alloy provides isolation of ultrasonic resonances and common resonance modes between different layers of metals such as aluminum or stainless steel.

These designs are further refinements of earlier generation RSC cables, such as the Decade and Master Generation 2. Several proprietary new technologies are employed, which make The One cables unique not just in the RSC line, but in the overall high-end audio cable market. Chief among these innovations is a new shield which offers a revolutionary approach to the problems of RF and EMI signal modulation.

## The Isolated Floating Shield: A Unique Approach

The One Analog and Digital Interconnects are the first interconnect cables in the world to employ a completely isolated, floating shield. Until the introduction of this technology, **the most common method of cable shielding was a twin-axial design employing a shield which floats at the source end and is grounded at the load end.** These designs are somewhat effective at reducing intermodulation of RF and EMI but suffer because **the shield is coupled to the circuit at the load end. Therefore much of the energy absorbed by the shield is reintroduced into the circuit via the ground connection.**

The Isolated Floating Shield used by The One is completely floating at both ends. When used with the Floating Ground Station, the shield is not coupled to any component in the system, not even to the cables themselves. This enables the energy in the shield to be transferred away from the signal, to a separate component called a Ground Station. (There are several different types of Ground Stations which will be discussed in some detail later in this paper. For complete information, please see the TARA Labs White Paper "TARA Labs Isolated Shield Matrix.")

By effectively isolating and transferring RF and EMI away from the audio signal, the Isolated Floating Shield eliminates almost every trace of RF intermodulation from the audio signal. Most audiophiles are familiar with the overt effects of RF intermodulation, which range from audible noise and hash to outright broadcast of commercial radio signals or CB transmissions. The subtler effects of intermodulation may go unnoticed because the result is an obscuration of low-level detail and ambient information which the listener may not have known is even present on the recording. RF Intermodulation may also present as brightness or an unnatural forward presentation of high frequency information.

The One's Isolated Floating Shield is unique in another respect. It is displaced farther from the conductors themselves than any interconnect on the market, including other TARA Labs' RSC designs. Multiple layers of Teflon tape are used to physically space the shield farther from the Rectangular Solid Core conductor inside the cable, thereby reducing the cable's capacitance and lowering RF intermodulation.

### The One and the Isolated Shield Matrix

The Isolated Floating Shield described above is part of a total system for the elimination of RF and EMI intermodulation known as the Isolated Shield Matrix. This system consists of three components: the interconnect cables themselves, the Isolated Floating Shield and a component known as a Ground Station. There are two types of Ground Stations, described below. Both are made of a Mil-Spec Aluminum alloy. The alloy was chosen for its specific metallurgical properties for the reduction of RF and Electromechanical resonance. It is 18-23% heavier than aluminum and stronger than aircraft-grade stock. This is the same alloy that is used in the Resonance Diffusers on all TARA Labs RSC cables.

**Inside the Floating Ground Station is a ceramic composite compound for the grounding of RF and EMI. This compound is comprised of metallic oxides and a specific amalgam of mineral elements in a ceramic binder.**

**Chassis Ground Station:** This component is supplied with every The One Analog and Digital Interconnect as standard equipment. It connects to the Isolated Floating Shield via two small leads. RFI and EMI in the shield is transferred to the Chassis Ground Station via these leads. The ground station itself is then connected by means of another lead to the chassis ground of the receiving component. This is where the energy absorbed by the shield is ultimately grounded.

This method of transferring RF and EMI energy is very effective at reducing intermodulation in the audio signal. Although it is coupled remotely to the system at chassis ground, it is not connected to the circuit.

An even greater reduction of RF intermodulation and a noticeable improvement in sound quality will be achieved with the use of Floating Ground Stations.

**Floating Ground Stations:** With the use of a Floating Ground Station, the most complete transference and grounding of RF and EMI energy is effected. There are three types of Floating Ground Stations: an Analog Floating Ground Station which accepts up to two pairs of analog interconnects, a Digital Floating Ground Station which accepts up to two digital interconnects, and a Phono Floating Ground Station, for tonearm hook-up.

The Floating Ground Stations are not connected to the system at chassis ground; they are themselves the grounding components. Therefore RF/EMI isolation and grounding take place in complete isolation from the audio system.

## **A Signal Free from RF/EMI**

The combined effect of the Isolated Shield Matrix (cable design, floating shield and ground station working together to reduce RF/EMI intermodulation) is a dramatic lowering of the noise floor in the audio signal. Low level detail and ambient spatial cues are revealed as never before. Because these cues lie in the high frequency band most vulnerable to RF, listeners hear details they never heard before: low-level noise may otherwise obscure the tapping of a foot, a background whisper, etc.

In removing RF intermodulation from the signal, The One enables the listener to hear not just the music, but to experience the acoustical space and environment in which it was recorded. Soundstage dimensions are wider, deeper and taller, and images within it are more clearly defined and layered in perspective.

## **The One Speaker Cable**

The One Speaker Cable employs tried and tested RSC design principles, taken to the ultimate level.

Thirty-five individually insulated RSC Generation 2 conductors per negative and positive leg are helixed around a large diameter (0.75") Teflon airtube dielectric. These conductors are insulated with the same glass microsphere insulation found in the interconnects.

Conductors are positioned around the center tube with a natural, random alignment. (See Figure 1) That is, the rectangular conductors are not aligned either plate to plate or edge to edge, so they are electrically decoupled from one another. This unique arrangement contributes to the very low inductance of the cable design.

Dotted lines indicate electromagnetic lines of force (flux). Conductors of like polarity aligned plate to plate (B) or edge to edge (C) have higher inductive reactance due to their electromagnetic coupling, causing roll-off of higher frequencies. Example (A) shows random alignment of conductors which results in no electromagnetic coupling.

Because of its unique construction, The One Speaker Cable offers the DC resistance (current carrying capability) of an eight gauge conductor, with the unsurpassed frequency linearity of an RSC Gen 2 conductor. This makes The One both the most powerful and the most accurate and neutral speaker cable on the market. This combination is unique. In typical cable designs a trade-off between DC resistance and frequency linearity occurs due to inductive reactance or the "Skin Effect."

# MAGNAN

## Magnan Type Vi and Signature Cables

The Magnan interconnects and speaker cables are the result of years of research to develop the best possible audio cable regardless of cost materials and labor. Through the use of new and innovative techniques, the Magnan interconnects and speaker cables drastically reduce audio band time smearing, associated phase shifts, and low level noise. There is a dramatic clarification of everything in the sound field with much better image focus, depth and width, much finer low level detail, and reduction of background noise. Highs are much more detailed but smooth and natural, and lows much more distinct and powerful. Multiple layers of congestion, muddiness, blurring or smearing of image, and overbrightness are removed and revealed to be interconnect and speaker cable degradations that had always been assumed to be caused by the electronics, speakers and recordings.

The philosophy of the designer, based on experience, is that the ultimate subtlety and resolving power of human hearing perception is vastly beyond present instrumentation capability and acoustical/neurological theory. Nevertheless, it has been very valuable to develop some understanding of underlying phenomena so as to be able to predict the most likely design approaches and material selections. The development of the Magnan cable designs was made possible by the discovery that the ear is very sensitive to the removal or reduction of skin effect-caused time domain distortions of the music signal occurring in the cables used in a music system.

Of course, any recording already contains the time smearing and distortion of many feet of conventional cables used in recording, mixing and mastering. Despite this, the time coherence of the few feet of cable used in playback is found to be critical to the final reproduced sound quality. An optical analogy is useful in understanding how this can be. An example is a film projector. The film print is very blurred and noisy because of film grain relative to the original scene due to losses in the negative and many steps of processing and duplication using imperfect lenses and film. Despite the "program material" being noisy and distorted, the image projected on the screen is still obviously different and inferior when using a poor quality projection lens when compared with a high quality lens. The quality lens is superior because it is achromatic (no color fringing and sharper focus) and because it has a flat field (entire picture in focus) with little geometrical distortion at the edges. The visual system easily detects a small reduction or increase in distortion and noise in an already distorted and noisy image. The auditory system must be similar in this capability. This is a sophisticated pattern detection ability and seems to be especially sensitive to differences when the comparison is between two different reproductions.

The skin effect phenomenon has been found to be the major signal degrading effect in conventional audio cables. These effects include smearing of musical details, smearing together of instrumental images, flattening of the sound stage, and usually a general overbrightness. Almost all conventional audio cables utilize relatively thick stranded or solid wires which inherently cause gross audio band skin effect time smearing. Even the existing ribbon designs are far too thick to significantly reduce the problem. The conclusion that skin effect is of preeminent importance in audio cables is based on lengthy experimentation with different conductors. The second most important problem parameter has been found to be dielectric absorption, primarily with interconnect cables. This is also addressed in the Magnan interconnects through use of a TFE Teflon/air space construction. Distortion introduced by the dielectric absorption in most plastic insulation materials is also a form of time smearing of the signal waveform which points again to the great sensitivity of the ear to time-related distortions. Many other commonly used parameters in audio cable design have been found to be either relatively unimportant or not applicable at audio frequencies. Examples are extreme conductor metal purity and characteristic impedance.

The physics of skin effect phase shift in wires have been well known for many years. A change in driving voltage causes a corresponding change in the electric field which is propagated almost instantaneously from source to load in the space around the conductor. The skin effect is physically caused by the frequency dependent attenuation and slowing down of the induced signal current as it penetrates into and propagates through the conductor. The higher the frequency the more the current is attenuated and slowed with depth from the surface, to the point where at RF almost all the signal current is concentrated in a thin "skin". The voltage generated at the load termination of the cable at an amplifier input, for example, is what actually controls the amplifier. This voltage is proportional to the total instantaneous signal current passed by the cable into the load. Since the signal current is stretched out in time, the signal voltage at the cable load or amp input is identically degraded.



The key to the detail and image smearing caused by this phenomenon is the fact that the part of a music signal at any given frequency is also smeared or spread out slightly in time. The signal current at any frequency is propagated through the entire conductor with the slowing, corresponding time delay and attenuation increasing continuously from surface to center. The leading edge of a signal arrives nearly instantaneously at the load, but it is always followed by a slight "shadow" or time-smeared replica. In addition, since the high frequencies predominantly arrive slightly earlier than the mid and bass frequencies, the sensitivity of the ear to early arrival sounds causes an apparent overbrightness.

The total music signal, composed of many different frequency components, is also slightly smeared out in time with the highs arriving slightly early. In conventional wire and cable this effect is so severe to the ear-brain system that it destroys a multitude of small but important sonic details, resulting in the blurring and flattening of soundstage muddiness, etc., described previously. The magnitude of the skin effect at any given frequency can be defined as the width in time of the signal waveform smearing. This time spread at any frequency is determined by the maximum distance the signal current can penetrate into the conductor (i.e., half the thickness), and by the maximum phase shift and attenuation which occurs at that depth. The more resistive the conductor material the less the attenuation and slowing of the wave as it penetrates and the smaller the maximum attenuation and slowing. Therefore, the thinner and more resistive the conductor, the less the skin effect caused time smearing and the greater the sonic resolution. No limit has yet been found to this relationship - no matter how thin or resistive the conductor is made it continues to improve the sound. This principle is the basis of the design of the Magnan interconnect and speaker cables.

Magnan Audio Cables has derived a "figure of merit" which in one number relates conductor thickness and conductor resistivity directly to the perceived sonic resolution of the wire when used in an audio cable. The larger the figure of merit the lower the time dispersion due to the conductor and the better the time and musical resolution. Listening evaluations of experimental cables using a large variety of different conductor materials and thicknesses have been conducted and have invariably verified the principle and calculated figure of merit as long as the conductor is nonmagnetic. These experiments have verified the principle that the greater the skin effect of a cable, the worse the time smearing, overbrightness and other degradations to the sound.

The data is graphically displayed in Figure 1. The figures of merit are relative to the performance of 20 gage copper wire, which is set equal to 1. A log vertical scale (1, 10, 100, 1000, etc.) is used, corresponding much more closely to actual hearing perception than a linear scale. As could be expected from the relative conductor performance figures, the Magnan Audio Cables achieve dramatic audible improvements over conventional cables.

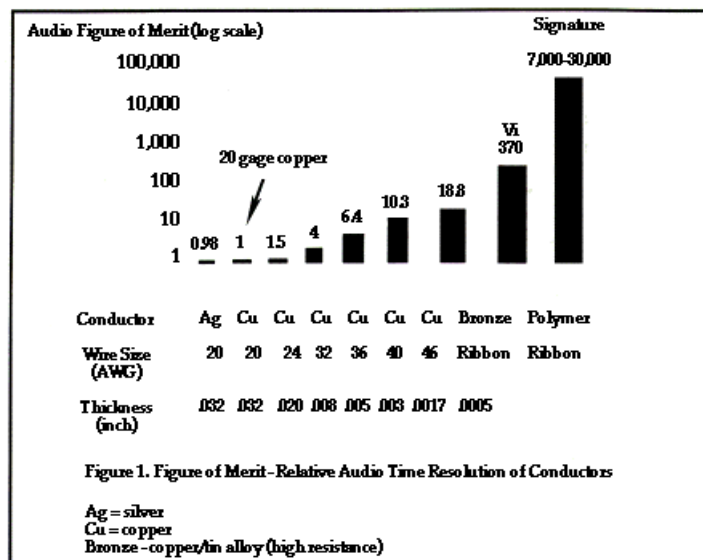

It was found that skin effect in the ground conductor of a single ended cable (RCA-RCA) also causes significant audible degradation since it returns the signal current to the source. Consequently, the ground return needs to have as small skin effect as possible along with low DC resistance to prevent hum. With the Type Vi this design parameter is achieved through use of a very thin copper foil strip ground return. An optimally thin metallized conductor is used in the Signature interconnects.

Use of a very thin high resistivity wire conductor is the least difficult and expensive construction minimizing skin effect. The Magnan Type Vi interconnects push the thin metal wire design approach as far as possible, using a 5/10,000 inch thick high resistivity bronze ribbon. The sonic results are transparency, ambience retrieval, image focus and soundstage size beyond any conventional cables using "normal" relatively thick wire. The Type Vi cables are completely handmade and are handsome in appearance, with a black braided nylon cloth jacket and label in gold and blue with directional arrow. Diameter is approximately 3/8" (RCA) and 1/2" (XLR).

A metal wire or ribbon can be made only just so thin before it becomes impossibly expensive to manufacture and too weak and delicate to utilize in a cable. The Magnan Signature interconnect cables drastically reduce skin effect caused degradations beyond the level achieved by the Type Vi using a proprietary high resistance nonmetallic conductor in the form of a very thin coating of conductive plastic "paint" on a wide plastic ribbon substrate. The high resistivity (thousands of  $\Omega$ ) of the coating further greatly reduces the skin effect time dispersion of the conductor. Also, the use of a nonmetallic, amorphous polymer conductor confers a large additional audible benefit in terms of greatly reduced background noise due to the absence of metal crystal grain boundaries and other discontinuities in the signal path.

To give some idea of the actual conductor dimensions involved, Figure 2 illustrates to scale the relative sizes of a fairly small conventional wire, a human hair, and the bronze ribbon conductor used in the Magnan Type Vi. The conductive plastic coating used in the Signature interconnect cable is 2-3 times as thick as the Type Vi bronze ribbon, but has thousands of times the resistivity of the bronze

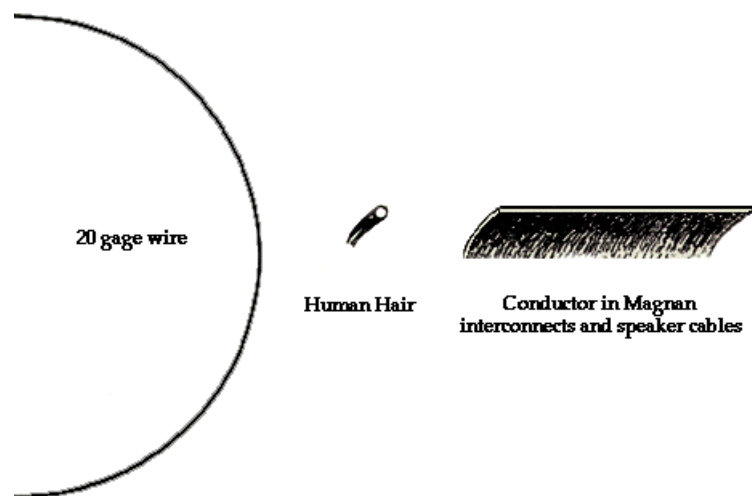

The total design of the Signature cable is complex and involves many tradeoffs resulting from the physics of materials and the constraints imposed by actual interfacing circuits. The key factor involved is that high resistance (thousands of  $\Omega$ ) is inherent in the conductor in order to achieve very low skin effect in the audio band with correspondingly very high time resolution. The better the time resolution performance the thinner and more resistive must be the signal conductor. The large resistance necessary for high time resolution in the Signature interconnect creates several interrelated performance tradeoffs which establish practical limits to achievable cable time resolution.

The primary tradeoff is between cable time resolution and overall system gain. The cable signal conductor resistance in conjunction with amplifier, etc. load input impedance creates a voltage divider which reduces gain. As an example, a 50,000  $\Omega$  cable into a 50,000  $\Omega$  input impedance at the amplifier would result in a 6 dB power or volume loss.

Another constraint on maximum achievable cable time resolution (i.e. on maximum allowable cable resistance) is the fact that the cable resistance in conjunction with cable internal capacitance plus load input circuit capacitance and load input resistance form a low pass filter. The maximum allowable cable resistance and load input resistance must be limited so as to keep this high frequency roll off well above the audio band. With tube input circuits the input grid capacitance will probably be greater than the cable capacitance, due to the so-called Miller effect where interelectrode tube capacitance is amplified by the tube voltage gain. Because of this, cable resistance needs to be limited to approximately 35,000  $\Omega$  when the cable drives a tube amplifier or other tube unit.

These tradeoffs have been worked out with the goal of optimizing overall performance with most systems. The Signature interconnect cable resistance is standardized at 30,000  $\Omega$  (approximate). Most systems have enough reserve gain to compensate for the resulting gain loss of one pair. Longer than standard 4-foot length cables utilize a wider ribbon and/or more layers to achieve the same total resistance and net time resolution as the 4-foot cable.

The Signature interconnect cables are terminated in short (3 1/2") small flexible leads ending in the RCA and XLR connectors. Due to the basic design, most of the cable length is of large diameter. The RCA-RCA version is approximately 7/8" in diameter and the XLR-XLR version is 1 1/4" in diameter. Despite their bulk, the cables are flexible due to use of convoluted Teflon tubing.

The best available connectors are used (based on listening tests). Of necessity, the Magnan Signature interconnect cables are completely handmade from the conductors out and present an exotic, rich appearance using double layer monofilament braid sleeving (translucent over black

## **Magnan Signature Speaker Cable**

In the case of speaker cables, it is much more difficult to greatly reduce audio band skin effect because of the need to have high conductivity metal with large cross-sectional area for low total resistance. Only one method has been found to work well - the "brute force" approach using a very thin, very wide copper ribbon with a resistance of no more than approximately .003  $\Omega$  per foot (9.8 m $\Omega$ /m). This low a resistance is needed for good bass control and extension due to the high drive currents and corresponding maximal cable voltage drops involved.

It was found that this simple design requirement was by far the most important for the speaker cable. The many other parameters commonly used in speaker cable design were found to be either relatively unimportant in the ribbon cable or not applicable at audio frequencies. Examples are extreme metal purity, dielectric material and characteristic impedance.

The resulting speaker cable is in the form of two separate five-inch (12.7 cm) wide flat cables for each speaker. For best performance the two separate flat cables driving a speaker should be laid side by side where possible rather than on top of each other. The physical appearance of the Magnan Signature Speaker Cable is high-tech with a glossy black nylon woven jacket.

The cable termination design accomodates closely spaced, hard-to-get-at speaker and amplifier binding posts by narrowing the end 7" down to a point to which is attached a short flexible lead with the required spade lug or banana connector.

## Silver Bronze Interconnect

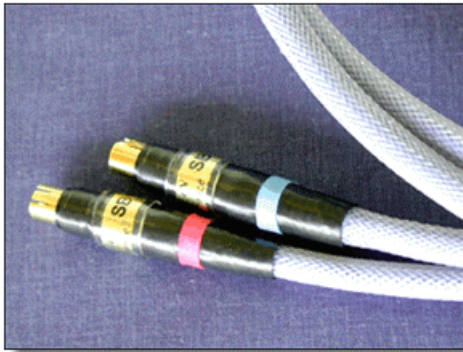

This at last addresses the need for an interconnect cable much better than the Type Vi at only a moderately higher price. Sonic performance is intermediate between the Type Vi and Signature. The Silver Bronze utilizes newly available ultra high time resolution metallic conductors for both signal and ground return. This cable pushes affordable metal conductor technology to a new ultimate.

Performance:	Skin effect time smear reduced to 1/6000 of 20 gage copper wire
Conductor:	New micro-thin silver and bronze ribbons
Dielectric:	Newly constructed TFE Teflon/air
Ground return:	Silver metallized fabric conductor
Diameter:	Approximately 3/8" RCA and 1/2" (XLR)
Maximum length:	6 ft
Termination:	Neutrix RCA and XLR
Single Ended, 4 ft standard length.	
Balanced, 4 ft standard length.	

## Reference Speaker Cable

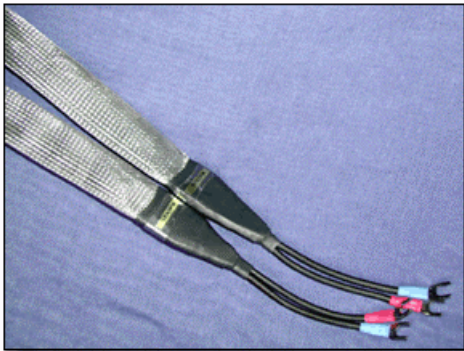

This new product addresses the need for a high time resolution speaker cable more compact than the Signature. The Magnan Reference speaker cable is basically a miniaturized version of the Signature speaker cable that achieves a sonic quality in the same class as the Signature relative to conventional cables. The design uses the same very thin copper ribbon conductor but in a stacked insulated foil construction. Like the Signature speaker cable, the sound of the Reference is very highly resolved, musical and free of colorations.

Performance:	Skin effect time smear reduced to 1/120 of typical conventional speaker cable.
Conductor:	Very thin copper foil (.00075"), stacked ribbon configuration. One 1-1/4" wide ribbon cable per speaker (contains both polarities).
Termination:	End 1-1/2" of each cable is narrowed down to two flexible leads with spade or banana connectors.
8 ft pair.	

## Magnan “Signature” Power Cable and Power Conditioner



Our research has finally led to an understanding of the most important interactions of AC power and audio systems, and to identifying the most important parameters in AC current and voltage filtering. The result is the new Magnan Signature power cable design, combining greatly reduced time dispersion ribbon conductors and proprietary built-in passive filtering.

This revolutionary power cable dramatically improves all sonic parameters - there is much greater resolution, image focus, dynamics, weight and impact, along with a much quieter background. CD playback is most improved, due to the particular sensitivity of digital timing jitter to noise on AC power

The Magnan Signature power cable is also available as a power conditioner where the load end is terminated in a hospital grade power strip. This allows the AC purification of a single Signature power cable to transform the sound of up to six components. Although the sonic improvements of a single Signature power cable/power conditioner are transferred fully through conventional components power cords, use of an additional Magnan Signature power cord to connect to the component will improve the sound greatly. The improvement achieved by a single Magnan power cable are directly additive with additional cables in series.

The Magnan Signature power cable is compatible with high-current solid state and tube power amplifiers, and with source components. It is recommended that the Magnan power cables be plugged into a wall socket and used as both a cable and a power-conditioner.

## Magnan Signature “Bronze” Power Cable

The engineering tradeoffs involved with our design allowed sonic performance to be increased even beyond the level established by the Signature standard power cable, as long as maximum current is limited. The “bronze” is compatible with source components only, such as DACs, transports, preamps, etc., and offers a much higher level of transparency, resolution and imaging. The design utilizes a “maxed-out” version of the built-in filtering in the standard Signature power cable and much lower time dispersion ribbon conductors.

For the absolute best sound, the “Bronze” should be plugged into the Signature power strip version, giving two Magnan power cables in series. One “Bronze” power cable can power several low-current source components with no loss in performance. To accomplish this, a custom adapter can be made going from a single male IEC with short cords to several female IEC connectors.

Diameter is approximately 1-1/4 with thin flex lead ends. Standard length is 8 ft, maximum length 12 ft.

Power Cables - Standard length - 8 ft  
IEC terminated  
Six outlet power strip, terminated  
Super Bronze-8 ft length only (just for source components)  
Power Cord without filtering

## Frequently Asked Questions

### Question: Are there any system compatibility issues with Magnan Cables?

**Answer:** The concern about “compatibility” is usually that the tonal or other characteristics of a system or individual components won't work with some cables, meaning the sonic characteristics would clash in some way. This concern is based on experience with conventional cables which are almost always to some degree tonally colored (such as overbright or dull or bass-heavy), and also smeared in the transients and textural details of the sound. Many audiophiles are accordingly used to using their cables in part as passive tone controls to counterbalance excessive dullness, overbrightness, edginess or other inaccuracies in their system. Of course, all components/systems plus room effects have such anomalies to some degree, but the most appropriate correction method is to apply system “adjustments” or “tweaks” which greatly reduce some of the aberrations at their source. See our Tweak Column for suggested approaches.

The Magnan Signatures, Type Vi and Type IIIi are extremely highly resolving and tonally neutral, with the degree of these characteristics ranked by the price points. Our cables are not tonally colored nor do they have other sonic aberrations of any significant amount. The Magnan interconnects and speaker cables are compatible with almost all systems, amps, preamps, speakers, etc., where “compatible” is defined in the best sense, adding and subtracting as little as possible from the music signal, in addition to being electrically and mechanically compatible. This also means the Magnan cables are not intended or suitable for use as passive tone controls in attempting to balance out error with opposite error.

With the Signature interconnects only, there are two exceptions to full compatibility with all components, due to the high series resistance of the Signature interconnects. This resistance is approximately 30 kΩ and causes some gain or volume reduction, the reduction in gain increasing with lower input impedances in the component (amplifier, preamp) being driven via the cable. This gain loss is entirely innocuous or neutral - the sound quality, resolution, frequency response, tonality, etc., are not affected, only the maximum volume available. The high cable resistance also causes problems in using a passive line stage to drive the Signature.

### Question: Do long lengths cause any problem?

**Answer:** With the Type Vi and IIIi interconnects and with the Signature speaker cable long lengths (15-5 ft.) do not significantly degrade the sound relative to the standard length (4 ft. - Type Vi, 1 m - Type IIIi, 8 ft. - Sig. speaker cable). Any effects are quite subtle. The Signature interconnects are limited by their design to maximum lengths of 10' (Signature RCA-RCA) and 5' (Signature balanced).

### Question: I am presently using (or considering) brand XXX cables. How would you compare these with your Signatures?

**Answer:** The Signature interconnect and speaker cables have a unique set of sonic characteristics. Unlike virtually all conventional cables they combine very high resolution of musical information, sense of transparency and three dimensional focused imaging with a warm, relaxed and neutral tonal balance. This comes about primarily because of their very high time coherence, which is the basis of my design philosophy reflected in all of my products.

Conventional cable designs each have at least a couple of areas of good or excellent performance but cannot get it all right most basically because of using too thick conductors. The most common (virtually universal) weakness of conventional cables is their lack of image focus and resolution. As a small audio manufacturer, there is no practical or affordable way to compare my designs with each of the scores of existing and new competing brands in this crowded high end audio area. I cannot, therefore, give a detailed comparative evaluation with specific brands. I can only assure you that the previous general comparison will hold true for this design also.

# Audioquest

The following discussion is based on decades of evaluation experience. It is not the result of "ivory tower" isolation. Designing, whether it be amplifiers, speakers or cables, requires attention to all empirical data, whether derived from test equipment or from human eyes and ears. Solutions come from an open-minded acknowledgement of all that is understood, and all that is not yet understood. Unfortunately, there is division in the audio/video community. At one extreme are those who only believe in their favorite measurements. At the opposite extreme are those who listen to or view a limited selection of equipment and then develop pet theories that conform to their limited experience. A lack of a proper scientific approach often causes each side to ridicule the beliefs of the other. The most effective audio and video designs come from those who take into account all the evidence, regardless of how measured or how well understood.

## Wire-Just Getting From Here To There

On the face of it, nothing could be easier than just getting an audio, video or digital signal from one place to another-no amplification, no conversion of mechanical energy to electrical energy or vice versa. The truth is, every cable must transfer a complex multi-octave signal without changing any of the information carried in that signal.

## Damage Control

We all like to describe how a good component improves the performance of our system, a perfectly legitimate comment. Unfortunately, buried in this statement is often the misunderstanding that the better component actually improved the signal in some way. There are certain areas of digital processing where this is possible, but in the analog world signals don't get better, they only get worse. The substitution of a superior component improves a system only because it causes less damage.

Cables, like all components, should be chosen because they do the least damage. This "damage" comes in two basic forms: a relatively benign loss of information, or a change to the character. A visual analogy might illustrate this distinction: consider "perfect" as a totally clear pane of glass. Since no component is perfect, the best we can strive for would be analogous to a pane of glass with a light gray tint. Lower quality components would have a darker gray tint. These various densities of gray tint would represent various amounts of lost information.

If the glass were tinted green or yellow or red, these colors would represent changes in character. We are far more likely to notice, and be bothered by, a light colored tint than a denser gray tint. It is this mechanism of character versus quantity that causes much of the confusion in the pursuit of higher performance.

## Chain Analogies, Synergy, Enhancement and Other Lies

We have all heard the truism that "a chain is only as strong as its weakest link." Certainly this is true of a chain, but it becomes a misleading lie when applied to the world of audio and video. The quality of sound coming from your speakers and the quality of picture from your video monitor have both been compromised by some degree of distortion in every component, starting with the microphone or camera. No one actually believes that if you changed every piece of equipment except the proclaimed "weak link"- that there would not be any change in the sound or the picture. No matter how bad a CD player might be, no one would argue that you couldn't hear the difference if you changed speakers. It is worth noting that some components are more cost-effective to change than others, or that a particular complaint will not be eliminated until a specific component has been changed. These truths might seem like an approximation of the chain analogy but the chain story has so much strength because it is an absolute, and it absolutely doesn't apply.

**The logic of a good system is very simple: Every component matters!** The electronics, the speakers, the cables, even every solder joint, all cause damage. Each component is like one of the dirty panes of glass in this illustration. Each one blocks a bit of the view. The quality of the final performance, or the clarity of the view, is the original signal minus the damage done by all the pieces in-between. Improving any one of the components will improve the performance. Cleaning any one of the glass panes will allow a clearer view

Recognizing that the challenge is to reduce negatives, to prevent distortion, makes it much easier to understand "unexplainable" improvements. If the panes of glass are not only dirty, but also have a red tint, then as each pane is cleaned and the tint is eliminated, the "view" of the music will improve as expected. However, the red, and the awareness of the red, will not be eliminated until the last pane has been de-tinted.

De-tinting this last pane will seem to make a bigger difference than de-tinting any of the previous panes. We are naturally more impressed by the elimination of the red tint than by the previous reduction in the tint's density. If you didn't want to hear traffic on the street, reducing the traffic from three cars per minute to none at all would be more impressive than reducing the flow from nine per minute to six. People are more sensitive to the presence of a phenomenon (the red or the cars) than to the quantity.

This type of surprise result, where we expected  $1+1=2$  and we think we got  $1+1=3$ , is often called "synergy." In truth, the "synergistic" aspect of this improvement would have been the same no matter which pane of glass happened to be the last one cleaned not much magic or synergy in that.

Sometimes we are faced with empirical data that we simply don't understand. However, such a lack of understanding doesn't mean the phenomenon is magical or incomprehensible. A visual analogy might be; just because something is too far away to see doesn't mean that the distance in-between is infinite. Our limitations might seem infinite, but that doesn't mean that a phenomenon we don't understand takes place on the same scale. A more rigorous application of logic and scientific method might prevent all the brouhaha we get about magical combinations.

Assembling or upgrading a system to cost-effectively maximize performance requires a broad perspective and a trustworthy evaluation methodology. Combined productively, these ingredients make the process predictable and enjoyable. (Please see "Evaluation Methodology" at the end of this booklet.)

### **The Challenge Of Speaker (High Current) Cable Design**

While there are many physical, electrical and magnetic phenomena responsible for distortion in cables, there are really only a few basic mechanisms which account for the majority of the performance variations between cables. After considering the following information and evaluating even a small variety of different cable types, you can acquire the ability to look at a cable's design and know pretty well whether it deserves your further attention. Please don't close your mind to new possibilities, just develop an educated skepticism.

**Skin-Effect is one of the most fundamental problems in cables.** It is useful to think of a metal conductor as a rail-guide. Electric potential is transferred as current inside a metal conductor and as a magnetic field outside the conductor. One cannot exist without the other. The only place that both magnetic field and current density are 100% is at the surface of a conductor. The magnetic field outside a conductor diminishes at distances away from the conductor, density is 100% only at the surface of the conductor. Something similar is true inside the conductor. Skin-effect means that current density diminishes at distances away from the surface on the inside.

There is some disagreement as to whether skin-effect is relevant at audio frequencies. The argument concerns whether skin-effect causes damage other than simply power loss. Since the 3 dB down point (50% power loss) for a certain size strand might be at 50 kHz, not everyone understands the mechanism by which skin-effect is a problem at audio frequencies (20-20,000 Hz). However, the problems are very real and very audible. This is because well before skin-effect causes a substantial power loss, it causes changes in resistance and inductance. Skin-effect causes different frequencies to encounter different electrical values at different distances from the surface of a conductor.

If a single strand is too large, skin-effect will cause each frequency component of an audio signal to behave differently. Each frequency component will exhibit a unique current density profile. The result is that some of the delicate high frequency information, the upper harmonics, will be smeared. We hear sound that is dull, short on detail and has a flat sound stage. The energy is there, the amplitude (frequency) response has not been changed, however the information content of the signal has been changed in a way that makes it sound as though the midrange notes have lost their upper harmonics.

There is a textbook equation which describes the reduction in current and power density at any depth from the surface of an electrical conductor. For copper the equation is: 6.61 divided by the square root of the frequency (Hz) equals the depth in mm at which the current density will be  $1/e$ . Since  $1/e$  is 37%, this equation tells us the depth at which the current density has been reduced by 63%.



For 20,000 Hz, current density is only 37% at a depth of 0.467 mm, which is the center of a 0.934 mm (18 AWG) conductor. Conventional use of the above formula falsely assumes that it is acceptable to have a 63% reduction in current flow and an 86% reduction in power density at the center of a conductor. However, this formula does not by itself describe at what depth audible distortion begins. Listening (empirical evidence) shows that audible distortion begins at somewhat lesser depths.

There is a solution to skin-effect - using a single strand of metal which is just small enough to push skin-effect induced audible distortion out of the audio range. Simple evaluation of multiple sizes reveals that audible skin-effect induced anomalies begin with a strand (or conductor) larger than 0.8 mm. A much smaller strand yields no benefits but encourages the problems discussed below.

A common misunderstanding of skin-effect results in the claim that "the bass goes down the fat strands and the highs go down the little strands." The surface of a fat strand is just as good a path as the surface of a thin strand, only the fat strands also have a core which conducts differently. In cables with fat strands which are straight and little strands which take a longer route, the path of least resistance at higher frequencies is actually the surface of the fat strands. Since the lower frequencies are less subject to skin effect, they travel everywhere in all the strands.

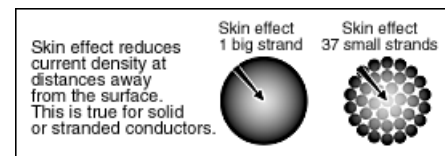

### Misunderstanding Resistance And Other Pitfalls

If a speaker cable used a single 0.8 mm strand of copper, it would have too much resistance to do its job properly. Speaker sensitivity varies, but if the path between the speaker and amplifier has too much resistance, the sound quality will suffer. Such degradation is not actually distortion in the cable, but is the result of using too small a cable. For this reason, even a short speaker cable should be at least 18 AWG (.82 mm<sup>2</sup>) or larger.

Power loss due to resistance is not usually a significant problem. If a very small cable were to cause a 10% power loss, the result would be like turning down the volume a fraction of one dB. If a signal has been robbed of the information that allows you to perceive dynamic contrast, harmonic beauty and subtlety, we tend to refer to the loss as an "amplitude" loss. However, the signal sounds so dull and lifeless at the far end of a poor cable not because of lost power, but because of added distortion.

Unfortunately, the language of audio very often includes misleading terms. Many types of distortion are referred to as making the sound "bright" or "dull", both of which imply a change in amplitude. "Bright" is often used as a way of saying that harshness in the upper midrange has somewhat the same effect as turning up the treble. "Dull" is often thought of as turning the treble down, even though it is usually the result of distortions which obscure information. In most products, and certainly in cables, the amplitude response (frequency response) is not the culprit.

Probably the biggest obstacle to predictably assembling a high performance audio or video system is too much thinking and not enough evaluating. It is tempting to follow some logical story as to why some key ingredient will make all the difference, when in fact, pursuing any one priority almost always means inadequate attention to dozens of other often more important concerns. Please be careful not to get seduced by some common myths. Simplistic and ineffective solutions are often "sold" as cures for complicated problems. Dogma isn't productive, results are what count. The best phono cartridges aren't the ones with the lowest tracking forces, S-video outputs are not necessarily better than composite, two way speakers are not necessarily better or worse than three way speakers, more powerful amplifiers are not etc. The most relevant fallacy in this discussion is the one about "the more strands, the bigger the cable, the better".

### Not Causing More Problems Than We Solve

The Trouble With Strands: Since a good speaker cable needs to have more metal than a single 0.8 mm (20 AWG) strand, our challenge is to provide a larger electrical pathway without introducing new problems. If we take a group of strands and put them into a bundle, the entire bundle will suffer skin-effect. The strands on the outside present an ideal electrical pathway, but the ones on the inside have different electrical values. This causes the same information to be distorted differently in different parts of the cable. The bigger the bundle of strands, the bigger the problem. If resistance is to be lowered by using a bundle of strands, the bundle size must be kept small. Possibly several separate bundles will be needed

There are many ways in which skin-effect causes more distortion in a bundle than in a single over-sized strand. Strands are constantly changing positions over the length of a cable. Some leave the surface and go inside, others are "rising" to the surface. Since the current density distribution in a conductor cannot change, some of the current (particularly at higher frequencies) must continually jump to a new strand in order to stay at or near the surface. Unfortunately, the contact between strands is less than perfect. **The point of contact between strands is actually a simple circuit that has capacitance, inductance, diode rectification-a whole host of problems.** This happens thousands of times in a cable, and causes most of the hashy and gritty sound in many audio cables. This distortion mechanism is dynamic, extremely complex, and because of oxidation will become worse over time.

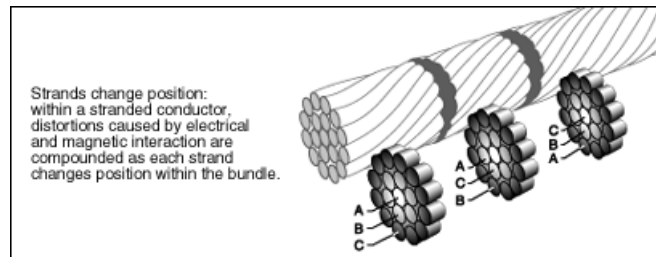

**Magnetic Interaction** is the other primary problem in cable design, both with a stranded conductor, and between conductors. A strand carrying current is surrounded by a magnetic field. In a bundle, each strand has its own magnetic field. These magnetic fields interact dynamically as the signal in the cable changes. On a microscopic level, a stranded cable is actually physically modulated by the current going through the cable. The more powerful magnetic fields associated with the bass notes cause the greatest magnetic interaction, which modulates the electrical characteristics of the cable, which in turn modulates the higher frequencies. Because the music signal modulates the contact pressure between adjacent strands, it also modulates the distortion caused by current jumping between strands.

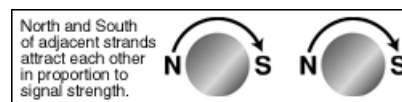

**Reducing magnetic interaction is the primary reason speaker biwiring helps so much.** Biwireable speakers have separate inputs for the bass and upper frequency ranges. These speakers simply allow separate access to the two halves of the "crossover". A crossover is simply a low-pass filter which allows low frequency energy to pass to the woofer, and a high-pass filter which allows higher frequency current to pass to the tweeter, or midrange and tweeter. These filters block the undesired signal by causing the amplifier to "see" an essentially infinite impedance (resistance) at the frequencies which are to be blocked. Because there is no closed circuit at the blocked frequencies, current at these frequencies does not travel in the cable-just like a light bulb which does not light when the electric switch is turned off, no matter how many megawatts are available.

Taking high frequency energy out of the cable feeding the bass does not significantly affect bass performance. However, taking the bass energy out of the cable feeding the tweeter or midrange/tweeter causes a big improvement. The magnetic fields associated with the bass notes are mostly prevented from interacting with and distorting the fields associated with the higher frequencies. While the fundamental bass frequency is not affected, the bass sounds better because the bass instrument's harmonics are in the midrange. The harmonics define the bass note and describe the instrument which created the note. Even if we could ensure absolute mechanical rigidity in a stranded cable, the interaction between magnetic fields would still be a prime source of distortion. Current within a conductor is directly proportional to the magnetic field outside the conductor. In most cables, the magnetic field of any given strand encounters a complex and changing series of interactions as it travels through a constantly changing magnetic environment. As the magnetic field is modulated, the audio signal becomes confused and distorted.

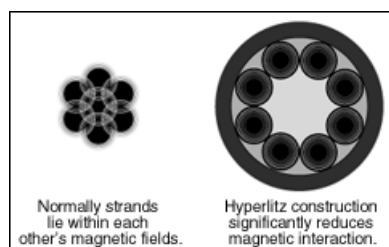

Distortion due to both magnetic interaction and from bare strands touching can be dramatically reduced by using Semi-Solid Concentric-Packing. In such a construction the strands are applied in a layer or layers spiraling around a central strand. Each layer is packed perfectly tight, exactly fitting around the strand or layer underneath. The strands in a given layer are uniform and never rise or fall to a different layer. This construction mimics many of the most important attributes of a solid conductor, while maintaining most of the flexibility of a stranded cable. The complete solution is solid conductors.

Magnetic interaction between conductors is also an area of major concern. This is discussed in the section following Material Quality.





**Material Quality** also dramatically affects the performance of cables and their terminations. By material quality we mean both the intrinsic quality of the metal, such as gold, nickel, brass, aluminum, copper or silver, and we mean the way the metal has been refined and processed. Pure silver is the very best performing material for audio, video or digital. However, if silver is not carefully processed, even low grade copper will sound better. Silver has also earned a confused reputation because sometimes the term "silver" is used to describe silver-plated copper. When carrying an analog audio signal, silver-plated copper causes a very irritating sound, sort of a "tweeter in your face" effect. In a different application, such as video, RF or digital, good silver-plated copper becomes an extraordinary value, out-performing even the highest grades of pure copper.

Why no gold wire? Because gold has neither low distortion nor low resistance. Gold is used on connectors because it is a "noble" metal, it doesn't corrode easily. Because gold is "noble" it is ideal for protecting more vulnerable materials like copper and brass. The nature of gold's distortion is mellow and pleasant, which makes it preferable to the irritating sonic signature of nickel. A bare copper or brass part will outperform a gold plated part, but only until the metal corrodes. In comparison, high quality thick silver plating actually improves performance. Silver is not noble like gold, but it does resist corrosion and it enhances performance.

As for conducting materials, normal, high purity (tough pitch) copper has about 1500 grains in each foot (5000/m). The signal must cross the junctions between these grains 1500 times in order to travel through one foot of cable. These grain boundaries cause the same type of irritating distortion as current crossing from strand to strand.

The first grade above normal high purity copper is called Oxygen-Free High-Conductivity (OFHC) copper. In fact, this copper is not Oxygen-Free, it should more properly be called Oxygen-Reduced. OFHC is cast and drawn in a way that minimizes the oxygen content in the copper: approximately 40 PPM (parts per million) for OFHC compared to 235 PPM for normal copper. This drastically reduces the formation of copper oxides within the copper, substantially reducing the distortion caused by the grain boundaries. Additional improvement can be attributed to OFHC copper having longer grains (about 400 per foot), further reducing distortion. The sound of an OFHC copper cable is smoother, cleaner, and more dynamic than the same design made with standard high purity copper.

Not all OFHC is the same. If the poorest copper were given a value of one, and the best was a ten, then OFHC ranges from two to four-it is actually a range rather than a single performance level. Since the most important audible attributes are due to the length of the grains, we use the name LGC (Long Grain Copper) to describe the very best OFHC.

	FPC	OFHC
Cast		
Drawn		
Material Quality: It's visible. It's explainable. It's audible.		

The next higher grade is an elongated grain copper sometimes called "linear-crystal" (LC-OFC) or "mono-crystal". These coppers have been carefully drawn in a process that results in only about 70 grains per foot. Cables using LC-OFC have an obvious audible advantage over cables using the same designs with OFHC or LGC. From 1985 to 1987 several AudioQuest models benefitted from this quality material.

In 1987 AudioQuest introduced FPC (Functionally Perfect Copper) in the higher models. FPC was manufactured by a process called Ohno Continuous Casting (OCC). Through this process, the metal is very slowly cast as an almost perfect single crystal small diameter rod. This near-perfect rod is then carefully drawn to maximize grain length. However, OCC is a process, not a material.

The metal (usually aluminum or copper), the purity, and the size of the cast rod all make a tremendous difference. FPC copper was drawn from a smaller rod, causing less damage to the near perfect cast state, a single grain was over 700 feet long. The audible benefits were very obvious.

A couple of years later the "nines" race began. This refers to how many times the number "9" can be repeated when specifying a metal's purity. In 1989 AudioQuest introduced FPC-6 in the highest models. FPC-6 had only 1% as many impurities as FPC. The prime contaminants in very high purity (99.997% pure, four nines) copper, like LGC and FPC, are silver, iron and sulfur, along with smaller amounts of antimony, aluminum and arsenic. FPC-6 was 99.99997% (six nines) pure with only 19 PPM of oxygen, 0.25 PPM of silver and fewer than 0.05 PPM of the other impurities. The improvement was dramatic. From 1989 to 1999, many of AudioQuest's most famous models used FPC-6.

As with OFHC and OCC, the nomenclature "six nines" or "eight nines" has almost no meaning. All else being equal, higher purity is a straight forward benefit. However, grain structure, softness and surface finish can each make more difference than a "nine" or two. Then there is the matter of measurable purity. Due to contamination caused by the measuring process, there is a serious question as to whether any metal can be verified as having greater than six nines purity. Also, since "nines" became a selling point, some quite absurd and dubious claims have been made. Let the ears beware.

Once copper has been processed and refined to the Nth degree, the only improvement left is to go to a long-grain high-purity silver. AudioQuest FPS (Functionally Perfect Silver) is just such a superior material. It was expensive, but the results were transparency, delicacy, dynamics and believability that weren't possible any other way, until PSC copper. FPS silver is still used to excellent effect in many CinemaQuest (from AudioQuest) wideband cable.

In the previous several paragraphs a number of important metallurgical concerns have been listed, such as purity, grain structure, softness and surface finish. Earlier in the discussion of skin-effect it was mentioned that the only place with 100% magnetic field and current density is at the surface of a conductor. This means that the surface purity and smoothness does more to define the sonic character, or hopefully lack of character, than any other part of a conductor. This is why AudioQuest's recently introduced new range of metals are called "Perfect Surface."

Perfect Surface Copper (PSC) is drawn and annealed through a novel proprietary integrated process which creates an exceptionally soft copper conductor with an astonishingly smooth and uncontaminated surface. Ever since the beginning, AudioQuest cables have improved over time. Starting in 1987 with FPC copper, a foundation was created by four levels of superb conducting materials. On this foundation, refinements such as SST continually provided further discrete improvements. With the introduction of PSC copper, a whole new foundation has been laid. For a price not much higher than FPC, PSC offers more natural and accurate performance than even FPS silver. AudioQuest's CV-4 speaker cable is identical to Type 4 in every way, except for the use of PSC copper instead of LGC. The new Coral interconnect is identical to the previous Ruby and Quartz designs, except for using PSC instead of FPC (Ruby) and FPC-6 (Quartz). By listening to these cables, anyone can hear exactly why AudioQuest.

### **Importance Of Overall Speaker Cable Geometry**

We have been discussing problems within a single conductor, solid or stranded, regardless of polarity (+ or -). The relationship between conductors is also very important. If this relationship is not consistent, then the electrical parameters (such as capacitance and inductance) of the cable will be constantly changing and the signal will be distorted. Conductors can be parallel, spiraled (twisted), or braided. These various geometries have certain inherent qualities. Parallel construction is inexpensive. Spirals have good RFI (radio frequency interference) rejection and usually lower inductance. Braids have good RFI rejection and low inductance, but suffer the consequences of a constantly changing electrical environment for each conductor.

A cable may have two or more conductors. The arrangement of these conductors dictates the magnetic interaction, the capacitance and the inductance of the cable. Both capacitance and inductance cause predictable and measurable filtering and progressively more phase shift at higher frequencies, though neither is a magic key leading to optimum performance. The effect of capacitance is somewhat like a cliff, you can go near the edge as long as you don't go over the edge. In a given application there is a value at which capacitance becomes a problem. At a lower value, away from the edge of the cliff, there is not much penalty. **On the other hand, inductance is always a problem - a constantly accumulating problem.** Capacitance and inductance are not the only important variables in cable design. However, it is productive to create cables whose capacitance doesn't "go over the cliff" while also designing for minimum inductance.

One theory of cable design holds that the characteristic impedance of a cable should match the impedance of the loudspeaker (When an antenna cable is referred to as 75 or 300, that is the characteristic impedance). Impedance matching is a valid concept which only applies when the impedance of the source, the cable and the load are all the same, and when the cable is longer than the wavelengths of the frequencies to be transmitted. Amplifiers do not have 4 or 8  $\Omega$  output impedances, in fact amplifier designers try to have as low an output impedance as possible. Speakers are all different and never have the same impedance at all audio frequencies. Since characteristic impedance equals the square root of the ratio of inductance to capacitance, very high (over the cliff) capacitance is a necessary corollary of a low characteristic impedance. Such high capacitance can severely affect amplifier performance and should be avoided.

Some of the first generation of specialty speaker cables had a characteristic impedance of about 8. These very high capacitance cables sounded better or worse because of their ability or inability to deal with the problems discussed earlier. However, many of these cables were accused of being extremely bright and irritating. It was not the cables which were so bright, it was the sound of the amplifier, which had been encouraged into instability by the cables.

Such false conclusions could be avoided if products were judged on their merit and then methodically analyzed. Consumers, store buyers, and reviewers each need to discover what sounds good. Unfortunately the desire to understand "why" can cause more confusion than insight if not pursued empirically as well as theoretically.

### The Challenge Of Interconnect (Low-Current) Cable Design

If you haven't read the previous discussion of problems in speaker cables, then please read that first. The following is meant to build on that foundation. The same problems exist in both high-current (speaker) and low-current (interconnect) applications. However, the hierarchy among these problems differs.

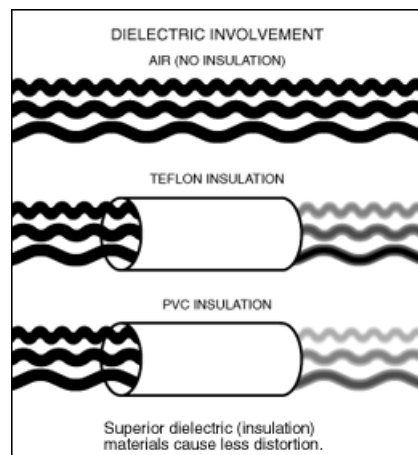

In low-current cables; skin-effect, electrical interaction, magnetic interaction and conductor quality are still primary problems. The negative sonic effect of internal mechanical modulation due to magnetic fields is greatly reduced.

The electrical behavior of the dielectric (insulating material) is much more important in low level cables. Dielectric involvement (the way in which a particular material absorbs and releases energy), has a profound effect on an audio or video signal. Dielectric constant, the most often quoted specification for insulating material, is actually not very helpful in understanding the audible attributes of different materials. The coefficient of absorption value is more relevant, and the dissipation factor and the velocity of propagation are even more useful.

The problem is that any insulating material next to a conductor acts like a capacitor which stores and later releases energy. This is true of circuit board materials, cables, resistors and of course capacitors. The ideal wire is one with no insulation except for air. When a solid material must be applied, it should be electrically invisible, meaning that the less energy it absorbs, the better. The energy which is absorbed should stay absorbed (turned into heat, a high dissipation factor), and the energy which does come back into the metal conductor should have minimal phase shift and not be frequency selective (a high velocity of propagation, independent of frequency). All dielectrics absorb more energy at higher frequencies, but some are more linear in their overall behavior relative to frequency.

The most commonly used insulations are PVC, polyethylene, polypropylene and Teflon. These can be mixed with air (foamed) or applied in ways which maximize the amount of air around the metal strands. Which material is used and how it is applied will dramatically affect the performance of a low-level cable.

Capacitance is more important in low-level than high-level cables for two reasons. If a long, "over the cliff" high capacitance cable is used, many preamplifiers, CD players, tuners, surround processors, etc., will not be able to "drive" the cable. The resulting distortion does not happen within the cable, but is caused by using the cable. There is never a disadvantage to using low capacitance low-level cables.

The other important reason for low capacitance is that high capacitance causes greater field strength between the positive and negative conductors (and the shield). This means more energy is put into the dielectric material. There is always a priority to minimize dielectric involvement, through proper selection of materials and low capacitance design.

### **Important Cable Facts**

**Running-In:** As with all audio components, audio cables require an adjustment period. This is often mistakenly referred to as "break-in". However, break-in is properly used to describe a mechanical change-engines break-in, loudspeaker and phono cartridge suspensions break-in. A cable's performance takes time to optimize because of the way a dielectric behaves (the way the insulating material absorbs and releases energy), changes in the presence of a charge. **Cables will continue to improve in sound or picture quality over a period of several weeks.** This is the same reason amplifiers, preamplifiers and CD players also require an adjustment period. The key difference between "adjusting" and "breaking-in" is that things don't "un-break-in", however, electrical components do "un-adjust". Several weeks of disuse will return a cable to nearly its original state.

The run-in time is essentially the same for all cables. However, the apparent need for run-in varies wildly. As with amplifiers and other components, the better the cable, the less distortion it has, and therefore the less there is to cover up the obnoxious distortion caused by being new. Since human perception is more aware of the existence of a distortion than the quantity, the better the cable, the worse in some ways it will sound when new, because the anemic forced two-dimensional effect resulting from being new will not be ameliorated by other gentler distortions. **Please be patient when first listening to any superior product.**

**Directionality:** All cables are directional, from hardware store electrical cable to the finest pure silver cables. All AudioQuest cables are marked for direction. With other cables it might be necessary to simply listen to the cables in one direction and then the other. The difference will be clear - in the correct direction the music is more relaxed, pleasant and believable. While cable directionality is not fully understood, it is clear that the molecular structure of drawn metal is not symmetrical, providing a physical explanation for the existence of directionality.

**Biwiring:** Many of today's speakers can be biwired. This type of speaker has one input for the woofer and a separate input for the upper frequency ranges. This often leads to the question "is biwiring so important that I should spend twice as much on cable?" Maybe it is worth spending twice as much on cable in general, but that's a separate question. Biwiring is a way to save money, to get higher performance for the same price. The biwiring question is not about how much money to spend, but about how to get the most performance for one's money. Biwiring is done in order to substantially reduce the distortion caused by speaker cable. In a biwire set-up the cable feeding the higher ranges no longer has to handle the large magnetic fields caused by the high current needed to produce bass. The bass fundamentals are not affected by biwiring, but the treble signal now travels a less distorted path. A little like the difference between swimming through waves versus through smooth water. The bass will sound better because bass definition is in the midrange and higher. It is worthwhile to take advantage of the benefits of biwiring when the speaker manufacturer has gone to the extra expense of including this capability. At the very least, please connect a single set of speaker cables to the treble input, and then use even a modest cable like AQ F-14 to jump down to the woofer. **Please replace the jumpers supplied by the speaker manufacturer.** These are self sabotage, by the speaker manufacturer and by any listener who uses them. Just like better electronics do not come with poor interconnect cables, it is best to pretend your fine speakers did not come with stamped metal jumpers. When biwiring, the two cables used must either be identical, or have essentially identical designs. If the cables have different inductance or capacitance, they will cause different amounts of phase shift. The integrity and coherence of the speaker will be compromised.

**Connections:** The highest quality connections are first made mechanically. Solder is never a good conductor, not even "silver solder." A good solder connection is one that uses as little solder as possible, and prioritizes the connection interface between wire, solder and plug. Welding makes the best connections: either resistance welding (which can be done with small cables), or cold welding (usually called crimping). When a connection is crimped hard enough to cause the metals to deform, to change shape, the area of contact becomes a "gas-tight" connection or a "cold weld." Any solder applied to such a quality connection is purely cosmetic. When connecting a speaker cable, much greater attention should be made to contact pressure than to contact area. A 14 AWG (2 mm<sup>2</sup>) connection is more than enough current path. It is much better to have a small area tightly secured than any larger area under less pressure. Speaker cables are sometimes quite large as way to dilute distortion mechanisms, not to carry more current. Please do not confuse this size advantage with the priorities at the connection point.

## The AudioQuest Objective

AudioQuest cables have a mandate: to transmit a signal without changing it. Since 1978 we have been actively researching the mechanisms responsible for altering an audio or video signal as it travels through a cable. The better we understand these mechanisms, the more effectively we can minimize their harmful effects. We take the only reasonable approach: instead of trying to fix something after it is "broken", we try to prevent it from breaking.

Every AudioQuest cable, from the least to the most expensive, is designed to minimize change. The problems we seek to conquer are the same for all cables. We make so many models of AudioQuest cables in order to ensure financial compatibility. We are certain to have several models which are extremely cost-effective in your system, whether it's a mini-rack system or state-of-the-art. The best cable is always the best cable, a difference you can hear on a boombox, but that does not mean that it's cost effective to make such a match.

Often we get the question "what is the best cable for my system?" Well, the best cable is always the best cable, and is always our most expensive cable. The audible advantage can be readily heard on a boombox. However, that does not mean that it's cost effective to make such a match. Every AudioQuest cable, regardless of price, is designed to minimize change. The problems we seek to conquer are the same for all cables. We make so many models of AudioQuest cables in order to ensure financial compatibility. We are certain to have several models which are extremely cost-effective in your system, whether it's a mini-rack system or state-of-the-art.

AudioQuest, the company, manufactures cables using the brand names AudioQuest and CinemaQuest.

## The AudioQuest Solutions

**Hyperlitz** construction is the ultimate solution. "Hyper" means to go "over, above or beyond". "Litz" type cable construction was invented long ago for the purpose of preventing skin-effect induced power loss in high-frequency applications. Conventional litz construction uses multiple individually insulated strands arranged so that no matter how big the cable, skin-effect is only that effect which would be associated with a single strand.

By "Hyperlitz" we mean a construction which meets the litz definition of reducing skin-effect to the strand level and a cable which goes significantly beyond conventional litz in its ability to prevent other distortions associated with the use of multiple strands. Conventional litz does not address the major problem of magnetic interaction. We have defined Hyperlitz as a construction which virtually eliminates magnetic interaction and ensures that the electrical characteristics of each strand are constant and unchanging over the length of the cable. Hyperlitz design fulfills the ideal of preventing the distortion normally associated with multiple strands or multiple conductors, yet allows us to make cables with a large cross sectional area and low resistance.

Litz design is a conductor specification, and therefore has no bearing on the relationship between conductors. Litz construction is completely independent of values such as capacitance, mutual inductance and resistance.

AudioQuest uses two basic versions of Hyperlitz construction. Most AudioQuest cables use a helical array of individually insulated solid conductors. The insulation is thick enough to provide significant magnetic spacing between the strands. AudioQuests previous top interconnect cables used a more complicated patented Air-Hyperlitz construction in which the strands are not insulated, but are instead isolated.

The metals surface was never damaged by a hot insulating process. Around its entire circumference, a metal conductor only touched solid insulation at four points, everywhere else was air. AudioQuest's new top cables now use polyethylene or Teflon tubes having an inner diameter larger than the outer diameter of the solid conductor inside. This means only one point of contact, more air, less distortion. Because low-level cables are most sensitive to dielectric involvement, such cables benefit the most from these superior construction techniques.

**Third Generation Spread Spectrum Technology (SST):** To minimize a distortion mechanism, one first has to be aware of it. Near the beginning of this discussion we discussed how skin-effect causes strands larger than 20 AWG (0.811 mm) to distort an audio signal. There is also some distortion associated with smaller strands. For sizes larger than 20 AWG, the audible skin-effect induced distortion is simply wrong. However, for sizes smaller than 20 AWG, even though the distortion signature is simply different for each size, one is not more wrong than the other, they are just different. There is no size or shape which doesn't have some limiting characteristics. The conductor shape which causes the least distortion is radially symmetrical. Round is simple, round is best.

SST, now in its third generation, is an extremely effective way to reduce distortion signatures and better preserve a natural homogenous harmonic balance across the entire frequency range. By using a multiple of different size conductors whose character flaws are similar but slightly different, the "visibility" of any one character flaw is greatly reduced. In order to optimize this defocusing of distortion awareness, the conductor sizes must be close together. If they are too far apart, then the cable simply has multiple compound character flaws. SST does not do the impossible: it does not eliminate this type of distortion. We can't actually strip away the undesirable artifacts, but we can make them virtually invisible (to the ear).

**Biwire versatility-using two speaker cables:** As discussed previously, it is important to biwire speakers whenever you have the option. **The two cables must be identical**, or must use essentially identical designs in order not to compromise the coherence of the speaker. If money were no object, double runs of our best cable would be an easy choice for everyone. However, since money usually is relevant, it is important to consider the best sounding and most cost-effective alternatives. As you will see below, many AudioQuest speaker cables are grouped into families which use very similar or identical designs. Within a family, cables can be mixed to create some very effective combinations. Since bass frequencies can never be harsh, it can be advantageous to use a cable with a lower quality conducting material for the bass in combination with a superior cable for the upper ranges. Within the AudioQuest line there are many opportunities to take advantage of this cost efficiency: Type 4 could be used on the bass with CV4 for treble; Bedrock on the bass might be used with Granite on the treble; Caldera on the bass with Kilimanjaro on the treble. You can biwire by using two separate pairs of cables, or you can use what we call a Double Biwire set. In such a set the two cables are joined together at the amplifier end so that only one spade plug goes to each amplifier terminal.

**Biwire versatility-using one speaker cable:** Many AudioQuest cables have the built-in ability to biwire with a single cable. Almost every AudioQuest cable can be used as a single biwire set in which the cable is prepared normally at the amplifier end. However, at the speaker end there are four connections instead of the normal two. Two of the ends are prepared 2" (5cm) longer (for the tweeter input) so that the cable will hang properly from all four connections. Please read individual cable descriptions and consult your dealer for recommendations.

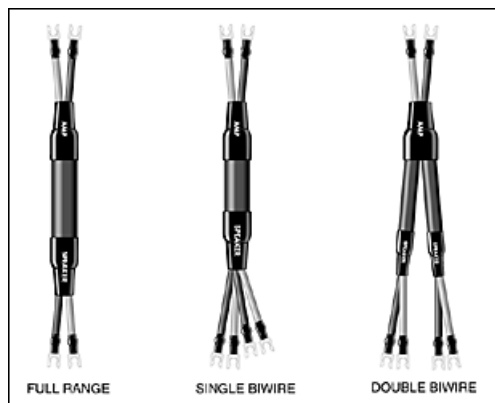

Biwiring within a single cable is a compromise, though often a very practical and cost-effective compromise. Much of the advantage of biwiring is due to magnetically isolating the high and low frequency conductors, and they cannot be isolated quite as well within a single cable.



However, single-bi wiring with Slate, Bedrock, Granite and Gibraltar speaker cables is always the most cost-effective way to biwire within their price range. This is true whether the speaker has its frequency range divided above or below the midrange. The conductor sizes and placement have been optimized to not only make the lowest distortion full range cable, but also to make the best universal single-biwire cable. The "flat rock" models, Slate, Granite and Gibraltar use double quad-helix, creating an unprecedented isolation of magnetic fields when these cables are used to single-biwire.

When the speaker is a three way or a panel/dynamic hybrid, the bass cable needs to have a good design and be big, but it doesn't have to be the best full-range cable since it carries such a limited frequency range. On the other hand, the cable carrying the midrange and high frequency information has to be a good full-range cable. It needs good design and size because the lower midrange has much the same requirements as the bass, and it must be extremely low distortion so that the more delicate high frequencies suffer minimal distortion.

If the speaker is a two way, then the woofer reproduces both bass and midrange, and only the tweeter is driven separately. In this situation it is the bass cable which must be a good full-range cable since it carries bass and very delicate midrange information. However, the cable driving the tweeter can now be quite small. Having low distortion is as important as ever, but carrying current is almost irrelevant as a tweeter receives very little power. With many previous models, and with the more expensive Caldera, Volcano, Kilimanjaro and Everest, when preparing the cable for single-biwire use, we divide the conductors differently. If the crossover frequency is high and the midrange is carried in the bass cable (biwire high), most of the conductors are used for the bass/midrange. If the crossover frequency is low and the midrange is in the treble cable (biwire low), then the conductors are divided more evenly. Using a single-biwire set can also increase system flexibility. If you choose to upgrade your system later, you can use the entire existing cable on the bass and simply add a second run of the same cable, or a run of a superior cable, for the top. For example, start with Bedrock as a single-biwire now, and have the option of adding Granite or Gibraltar as the treble cable later.

Following are descriptions of the various AudioQuest cables. You can see how the previously discussed problems are dealt with and in large measure overcome.

### Flat Hyperlitz Speaker Cables



**AudioQuest F-14** is flat! The third generation SST version of F-14 is 0.45" (11.4 mm) wide and only 0.10" (2.5 mm) thick. In addition to excellent sound, easy preparation and low cost, F-14 runs neatly under carpets or along baseboards and up walls. F-14 uses four solid LGC (Long Grain Copper) conductors; 2 x 21 AWG and 2 x 18 AWG. One of each size for positive and one of each for negative, making 16 AWG (1.23 mm<sup>2</sup>). All strands are spaced apart, making this a flat Hyperlitz cable. F-14 is available in blue or white.



**AudioQuest F-18** is also a flat Hyperlitz, still only 1/12" (2 mm) thick and 5/8" (16 mm) wide. F-18 uses eight solid strands of 20 AWG (0.52 mm<sup>2</sup>) LGC, four for positive and four for negative, making 14 AWG (2.06 mm<sup>2</sup>) when used full range or 17 AWG x 2 for single biwire. F-18 is available in brown or white.

### Helical Array (Round) Hyperlitz Speaker Cables with Spread Spectrum Technology

All these speaker cables employ Hyperlitz design and Spread Spectrum Technology for optimal performance. Please also see the SA-Series cable section on page 13 for information on additional Hyperlitz SST models.



**AudioQuest Type 2 SST** Hyperlitz uses four individually insulated LGC copper conductors, two are 21 AWG and two are 19 AWG, making this a 17 AWG (1.06 mm<sup>2</sup>) cable. These conductors are spiraled for optimal signal carrying characteristics and good RF rejection. The four-conductor geometry provides a superior balance of forces between the opposing conductors. The performance is audibly superior to using the same conductors as a double set of twisted pairs. "Mild Red" satin outer jacket. (UL/CL-3 rated.)



**AudioQuest Type 4 SST** Hyperlitz uses two solid 20 AWG (0.52 mm<sup>2</sup>) and two 17 AWG (1.02 mm<sup>2</sup>) LGC conductors. One of each size used together makes 15 AWG (1.56 mm<sup>2</sup>). Available in Blue or White (both UL/CL-3), or with a Blue/Black textile outer braid (not UL rated).

This finely tuned "4" design maximizes the amount of metal which can be used in a four conductor cable. If the 20 AWG conductor were larger, skin-effect would smear the high frequencies, if the 20 AWG were smaller, the character flaws of the 21 and 17 AWG conductors would be heard as two flaws instead of working together as the 20 and 17 AWG conductors do to minimize any such awareness (SST). If the 17 AWG conductor were smaller, the cable would lose some "authority." If the 17 AWG were larger, the 20 and 16 AWG conductors would lose their SST advantage



**AudioQuest CV-4** is "living" proof that metal quality can make a huge difference. CV-4 uses the same exceptionally efficient design as AudioQuest Type 4 speaker cable. While Type 4 takes advantage of LGC (Long Grain Copper) in order to provide high performance at an excellent price. CV-4 uses the astonishing new PSC (Perfect Surface Copper) in order to "get out of the way" far more completely. CV-4 is smooth, pure, clean and dynamic to an extent not previously possible anywhere near this price, even from AudioQuest. While CV-4 is a wonderful full-range cable, it will perform even better when two CV-4 cables are used with biwireable speakers; serious take-no-prisoners performance. With two-way (high crossover) loudspeakers, CV-4 also makes an excellent single-biwire cable. To single-biwire a three-way (low crossover) speaker we suggest considering Slate or especially Bedrock. Available in Sea Green, Navajo White (both UL/CL3) and Green/Black textile braid.

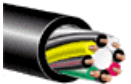

**AudioQuest Slate** maximizes the benefits of third generation SST design by using four different size solid LGC conductors; 2 x 21 AWG and 2 x 18 AWG form the "treble half" of Slate. 2 x 19 AWG and 2 x 16 AWG form the weightier "bass half." The eight conductors are spiraled together in a OctoHelix Hyperlitz configuration. Used full range, Slate is a 12 AWG (3.09 mm<sup>2</sup>) cable, big enough and designed to also be a very effective single-biwire cable. The eight conductor circular array allows each conductor to be more evenly balanced between its neighbors, providing superior performance over a four conductor cable. Between SST and a new conductor layout, Slate makes such effective use of the latest LGC copper, that it outperforms the previous LGC/FPC hybrid Indigo cable. Satin black jacket.

## Hybrid Technology

Almost every cable from Indigo and above uses this very cost-effective technique for greatly reducing distortion. AudioQuest Hybrid Technology takes advantage of an effect very similar to that obtained with bypass capacitors. In electronics and speaker crossovers, distortion is dramatically lowered by using a high quality/small value capacitor in parallel with a lower quality/large value capacitor. The total expense is closer to the cost of the less expensive type of capacitor alone, while the performance is closer to that which would be provided by a far more expensive high quality/high value capacitor. In our case we mix solid conductors using different grades of metal. The cost is closer to only using the lesser metal, while the performance is closer to only using the superior material.

This beneficial effect is further increased when combined with Spread Spectrum Technology. Due to skin-effect, the smaller conductors are superior at higher frequencies. Even though all conductors use the same metal, it is the smaller conductors in Slate that determine the character of the entire cable. This bias towards the sonic signature of the smaller conductors magnifies the benefits of using superior metal in only the smaller conductors, as in Indigo and others.

## Double Quad-Helix Construction - The Flat Rocks

These three cables use the same remarkably effective Double Quad-Helix design. Eight conductors in the same four sizes as in Slate (16,18,19,21) optimize the potential of SST (Spread Spectrum Technology) to minimize audible character flaws. In the explanation of Type 4 above, it is explained why none of the conductors in Type 4 (or CV-4 or KE-4) can be any larger or smaller without sacrificing quality. However, with eight conductors in two four-conductor helices, the game changes. In the "bass half" of the Flat Rocks, all four conductors are one size larger. The cable has better authority, and the loss of high frequency detail does not matter. In the "treble half" of the Flat Rocks, the four conductors are all one size smaller, allowing an even more open and detailed top end. If used full range this would compromise bass weight and cause a light sound (compare Type 2 to Type 4). However, when all eight conductors are combined, the SST Double Quad-Helix design allows unprecedented clarity and dynamics.

A wonderful byproduct of the superbly effective full range design of the Flat Rocks, is that these models are also ideal for use as single-biwire cables.

The "bass half" and "treble half" have already been optimized for their particular priorities, and they have a degree of magnetic isolation not found in any other single-biwire cable.



**AudioQuest Bedrock** uses the incredibly efficient Flat Rock design. Bedrock is our most affordable cable that combines Third Generation SST, Double Qua-Helix Geometry and Hybrid Technology. The 19 AWG and 16 AWG conductors in the "bass half" are LGC (Long Grain Copper). The 21 AWG and 18 AWG conductors use our amazing PSC (Perfect Surface Copper). When used full range, the hybrid use of PSC/LGC coppers provides much of the benefits of PSC, while keeping the price closer to LGC. When used for single biwire, the more sensitive "treble half" is pure PSC, making Bedrock an ideal single-biwire cable; especially for three-way (low crossover) speakers. This Mild red cable is 12 AWG (3.19 mm<sup>2</sup>) Mild Red cable.



**AudioQuest Gibraltar** is The Top Rock! The big difference in this dark blue cable is the quality of the metal. In this fine-tuned Hybrid design the character of the overall cable is determined by our proprietary PSC+ copper used for the 21 and 18 AWG and 19 conductors. Only the large 16 AWG conductors are the remarkable, but in this case inferior, PSC copper. As even the "bass half" of this Flat Rock is a hybrid, even the bass half has mostly the character of PSC+. Leaving only the largest treble impaired 16 AWG conductors in PSC saves money and gives up almost nothing in absolute performance. Thanks to the use of these exclusive coppers, the music is sweeter, cleaner and more dynamic. As with all the other Rocks, Gibraltar is also excellent for single-biwire use, or to make a double-biwire set with Bedrock or Granite on the bass.



**AudioQuest Granite** uses the same design and geometry as Bedrock. In this design, all the conductors are PSC copper. PSC has an astonishingly smooth and pure surface. Proprietary metal processing technology protects the wire's surface at every stage of drawing and fabrication. When high-purity low-oxide copper is kept as soft, pure and smooth as possible, it becomes a wonderfully low distortion conductor. For fifteen years, AudioQuest has pioneered the use of superior metals; yet even we were surprised by the huge leap in performance. PSC clearly outperforms previous AQ metals that cost over ten times as much. Thanks to the exclusive use of copper, the music is sweeter, cleaner and more dynamic. As with all the other Rocks, Granite is also excellent for single-biwire use, or to make a double-biwire set with Bedrock or on the bass.

### Counter Spiraling Circular Helix Hyperlitz - The Earth Features

If the only change to the new AudioQuest cables was the inclusion of the wonderful Perfect Surface metals, we would be shouting from the rooftops about our great new cables. If the only difference in the new cables was Third Generation SST, we wouldn't shout as loudly, but even a quick listen would show that the SST improvement alone would easily justify new models and a proud designer. If Double Quad-Helix construction were our only new trick, that alone would provide reason to sing the praises of the Flat Rocks.

However, there is even more to shout about. The top four new models have enough conductors to be able arrange them in a new and extremely effective manner. In each Earth Feature cable there is a circular array of positive conductors spiraling in one direction. Around this helix is another circular array of negative conductors spiraling in the opposite direction. The inner group spirals more quickly (has a shorter lay length), while the outer group spirals more slowly (longer lay), so that for every foot or meter of cable, the length of the positive and negative conductors is equal.

This arrangement meets the Hyperlitz criteria of a never changing regular and fixed relationship between positive and negative; the two cylinders of conductors are in a fixed non-changing relationship, even though the conductors are crossing each other instead of being in parallel. This crossing of conductors has always been sited as (potential) the advantage of a braided cable. However, the magnetic disruption (as the high frequency engineers call it) in a braid causes far more audible damage than any benefit from non-parallel conductors.

Since all four of these great cables use new Perfect Surface metals, all include third generation SST, and all are bigger and meatier than anything from AudioQuest since the 1980's; it is impossible to listen to the magnificent performance and hear just the contribution made by the Counter Spiraling Circular Helix construction. We can tell you that this construction technique is crucial to these cables' ability to clearly place individual sounds all over a huge three-dimensional stage.

All the Earth Feature cables were first optimized for their full range performance.

Then when decisions were made about the spacing of the conductors in the outer circular array, they were divided into bass, midrange and treble groups. This facilitates superior single-biwire performance. To achieve maximum results, the cables should be specified as "single-biwire high" for use with two-way dynamic speakers, or as "single-biwire low" for use with three-way or two-way hybrid speakers (such as electrostatic/dynamic hybrids).

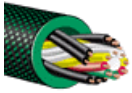

**AudioQuest Caldera** is a rich green cable (a very bright green jacket under an open weave black mesh) using 16 conductors in 4 different sizes. In this a fully optimized third generation SST design there are 4 x 22 AWG, 4 x 20 AWG, 4 x 18 AWG and 4 x 16 AWG conductors, creating a 9 AWG (5.94 mm<sup>2</sup>) cable. In a strong demonstration of well applied metal hybrid technology, the 4 smallest conductors use PSC+ copper. This substantially raises the performance above what even the incredible PSC copper could provide on its own, and yet since only the smallest conductors are PSC+, Caldera is nearly the price of a PSC only construction.

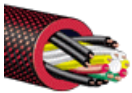

**AudioQuest Volcano** use the same "full size" design as AudioQuest Caldera. Big, bold and very beautiful; we mean the sound, not just the physical presence. This deep red (bright red under black mesh) cable uses PSC+ for all sixteen conductors. Once again, after having just sung the praises of a well designed hybrid, we must definitively state the in-your-ears advantage of an all PSC+ construction. When used as part of a double biwire combination, Caldera could be used on the bass, or when used with Kilimanjaro or Everest on top, Volcano could be used on the bass.

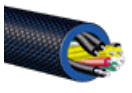

**AudioQuest Kilimanjaro** is smaller than the earth feature cables, but it is still a large authoritative cable. Kilimanjaro use 10 solid PSS silver conductors, adding up to a 12 AWG (3.49 mm<sup>2</sup>), inside a deep blue (bright blue under black mesh) cable. There are 2 x 22 AWG, 4 x 20 AWG, 2 x 18 AWG and 2 x 16 AWG conductors; the full compliment needed to take full advantage of current SST design. Since the outer layer of a counter spiraling design is always a circular array, the inner positive group must also have enough conductors to make a circular array. Kilimanjaro has the five positive conductors necessary. Custom machined deep blue anodized aluminum "breakouts" are used to finish the ends of this beauty. However, there is nothing inside these lovely ends, nothing to get between you and the music! With almost every step through the AudioQuest range, the next model up is simply better in every way than the preceding model. Kilimanjaro is one of the exceptions. Since "KJ" is smaller than the rest of the Earth feature cables, KJ has a little less weight and authority when used full range; but it has extreme clarity! KJ is a large full range cable, just not as large as its cousins. If KJ is used in a double-biwire combination with any of the four Earth Feature cables (including itself), this possible trade-off is eliminated.



**AudioQuest Everest:** The name says it all. This has to be the greatest of the great. Everest uses our exclusive solid PSS silver for all sixteen of its conductors. The very best design and the very best materials. The clarity, detail, finesse and the explosive dynamics speak for themselves. Full range, biwire-high, biwire-low, or combine with any of the Earth Feature cables for a double-biwire setup.

### Audio Interconnecting Cables

All the AudioQuest interconnecting cables are low capacitance. They can all be used in long lengths with most any preamplifier. Using a CD player (or tuner or tape deck) with a passive preamplifier can yield unpredictable results no matter what cable is used. However, AudioQuest cables have an extra advantage in these applications and will allow the best possible performance.

Often the cosmetic qualities of plugs are used to judge the value of an interconnecting cable. This is a terrible mistake. How the plugs look and feel has nothing to do with sound quality. AudioQuest plugs look great, but it is their superb sound which is most important. The various AudioQuest cables use several different plugs, most with Teflon insulation, all with precisely applied gold or silver plating, and all making excellent electrical contact. Some models are carefully soldered using the best available solder, most models are resistance welded. Welding sends 8,000 amperes through the junction of wire and plug for 33 millionths of a second. The resistance of the metals turns some of this energy to heat, which causes the molecules of the cable and plug to commingle in an essentially perfect connection, a difference you can clearly hear.

All the AudioQuest interconnect cables can be special ordered as "Y" connectors. We recommend that you avoid "Y" adapters and instead use a custom "Y" with both "legs" long enough to reach the equipment directly. We can even mix the cables, you could use Diamondback to a woofer amp while using Viper to the main speaker amp with both cables joined to a single plug at the preamp output. We also offer the excellent AQ M22F one piece "Y" adapter.

### Accessory Cables

AudioQuest Python Jumper Cables are short, positive conductor only cables which replace the horrible little "U" plugs on many receivers and integrated amps. The AQ Python Jumper Cables use solid PSC+ together with high quality RCA plugs. The result is like replacing a worse than bad cable with the equivalent of Python-for very little cost.

### Interconnecting Cables



**AudioQuest Sidewinder** uses two solid LGC copper conductors in a novel symmetrical Hyperlitz arrangement. One conductor is insulated and used for positive. The other is uninsulated and makes contact with the 100% coverage shield, allowing it to connect (drain) the shield while at the same time being used as a high quality conducting path for the negative signal. This mild red jacketed cable carries a UL CL-3 rating, enabling it to be used inside walls without conduit.



**AudioQuest Copperhead** uses two solid PSC copper conductors in the symmetrical Hyperlitz arrangement. One conductor is insulated and used for positive. The other is uninsulated and makes contact with the 100% coverage shield, allowing it to connect (drain) the shield while at the same time being used as a high quality conducting path for the negative signal. This black PVC jacketed version of this cable carries a UL CL-3 rating, enabling it to be used inside walls without conduit.



**AudioQuest Diamondback** uses two solid PSC conductors, and what a difference PSC makes. This extremely long grain copper allows for clarity and dynamics simply not possible with lesser materials. Double Balanced Hyperlitz design welded connectors and superior materials make this blue and black textile braided cable a great value.



**AudioQuest Coral** is a Triple Balanced cable featuring Hyperlitz construction. Coral uses three solid PSC copper conductors, each insulated with foamed Polyethylene. When used single-ended (with RCA plugs), one conductor carries the positive audio signal, two carry the negative. The 100% coverage shield is only attached at one end so that it is not used as an inferior audio conductor.

When used with balanced equipment (XLR type connectors), one conductor is used for each of the three signals (positive non-inverted, positive-inverted and the reference ground). The shield is connected to the case of the XLR at both ends to ensure ideal chassis to chassis grounding.

The audible differences resulting from multiple single construction, PSC copper, and not using the shield to carry audio information are dramatic. Coral is available with either the superb AQ #788 RCA plug or with AudioQuest custom #20 and #21 XLR plugs both color coordinated to match Coral's distinctive black and red braided jacket.

When a double balanced (or twin axial) cable is used "single ended" (with one RCA plug on each end) the shield is not used as an audio conductor, it is only grounded at one end. This provides complete shield coverage while preventing the shield from being used as an inferior audio conductor.

When a double balanced cable is used with balanced electronics, it usually has XLR connectors on both ends. One conductor is used for each of the two positive signals, and the shield is used for ground. To us, this is a step backwards: the reference ground is just as sensitive to distortion mechanisms as the positive signals and so deserves exactly the same respect. For this reason (and for better performance when used with RCA plugs) all cables from Coral and above are triple balanced.

An XLR plug can make four possible connections. AQ triple balanced cables use the three pins or sockets to connect the reference ground and the inverting and non-inverting positive signals. The case of the XLR is used to connect the shield to chassis ground.

The AudioQuest #700 series RCA plugs and most CinemaQuest RCA plugs employ a patented design which eliminates extra internal contacts, ensures a large self-wiping (self-cleaning) contact area, and provides extraordinary strain-relief. Very thick high purity silver plating actually provides a superior parallel conducting path. For the same reason Hybrid design works so well in many of the AQ/CQ speaker cables, it also makes for superior plug performance. All the same plugs are resistance welded to their respective cables in a process which actually commingles the molecules of the cable and plug into a single alloy. 8,000 amperes of current are put through the cable plug interface over a period of 33 millionths of a second. The extremely localized super-heating causes the metals to melt and become one.



**AudioQuest Viper** uses three wonderful PSC+ conductors. Patented Air-Hyperlitz construction provides radically better performance. The same adjectives apply over and over; great ease, better preservation of dynamic contrast and of all the elements that make music involving. This beautiful black Triple Balanced cable is welded to #708 RCAs or #20/21 XLRs. Both types of plugs use direct-silver plated FPC copper for dramatically improved performance.



**AudioQuest Python** uses an extremely effective Air-Hyperlitz construction. It uses PE air tubes to isolate the PSC+ copper conductors. Compared to the solid PE insulation in Viper, PE tubes allows for considerably tighter focus and less overhang, cleaner sound and tighter bass. This bright Green/Black mesh Triple Balanced cable is welded to a superior color coordinated connector.

**Air-Tube** construction prevents damage to the surface of metal conductors. Because the metal conductors are isolated by non-conducting elements, the metal is never subject to being coated with a hot synthetic. Even more importantly, each solid conductor only touches the supporting tube at one point around the outside of a conductor. Air is the primary insulation, a far superior dielectric to any solid material.

All AudioQuest RCA and XLR plugs are made from solid FPC copper. Most copper, regardless of purity, is too soft to make an effective plug. However, in addition to providing a superior signal path, FPC copper is strong enough to fabricate into truly superior plugs.

### Digital Cables-Wire and Optical

There are four standard ways that a digital signal is carried from one piece of equipment to another. The four different types of cable are each connected to a different type of transmitting and receiving circuit.



**S/PDIF or "digital coax"** cables look like normal cables. However, for superior performance, they must be specially designed for wideband applications. These 75 cables are used with either RCA or BNC connectors depending upon the equipment.



**AES/EBU** is a balanced wire system. This professional standard has been around for many years, but has only recently been adopted by the home market. AES/EBU uses a balanced 110 cable fitted with XLR plugs.



**Toslink or EIA-J**, is the most common fiber optic system. Toslink cable usually contains a synthetic (plastic) light conducting fiber, though the best Toslink cables use quartz fiber (glass).



**"ST"** is the highest quality fiber optic system used in audio. As the specifications for this system were set by AT&T, it is most often called AT&T or "glass". However, neither term actually defines the system. ST is just one of many fiber optic standards set by AT&T, and many companies besides AT&T make parts that conform to the "ST" standards. ST systems operate at seven to fourteen times the frequency bandwidth of the Toslink system.

If you have the choice of using Toslink or ST, you will obtain higher performance with ST.

In a choice between coax and AES/EBU, odds are in favor of AES/EBU, but not always, it depends on your transport and your digital processor. Between ST and a wire system, it also depends on the specific equipment-and it always depends on the cable.

Comparing a high quality coax against a normal Toslink, or a quality Toslink against a poor AES/EBU isn't going to tell you which system is better. If you compare systems using AudioQuest digital cables with similar prices, you will get a fair reading as to which system yields the highest performance with your equipment.



**AudioQuest VSD-1** (digital coax) "coax" cable has very low jitter. However, this cable is also a tremendous high performance cable in all 75 applications. This is why the cable in a Digital One package is actually our incredibly versatile new VSD-1. The initials stand for Video, Satellite and Digital; just a sampling of the signals this cable was designed to handle with minimum loss and minimum distortion. VSD-1 is simply better, objectively better, than our previous superb Digital One cable so we kicked Digital One out of the package and upgraded the performance by putting VSD-1 inside instead.

**SP-LGC** (Silver Plated Long Grain Copper) is a crucial ingredient in VSD-1 (and in most of our wide bandwidth cables). SP-LGC sounds horrible when used for an analog audio signal, but for a digital audio signal it works wonders over even the finest pure coppers. HCF (Hard Cell Foam) is used to insulate the large 19 AWG center conductor because it puts the maximum amount of air around the conductor, and yet HCF is hard enough to guarantee extremely consistent impedance, which is crucial to good high frequency performance.



**AudioQuest VSD-2** "coax" uses an 18 AWG HCF (Hard Cell Foam) insulated SP-LGC conductor. The larger center conductor along with a combination foil, Silver-Plated LGC shield and a welded silver-plated connector offers improved performance for both long and short lengths.



**AudioQuest VSD-4** "coax" uses HCF insulated solid FPS silver conductors in coax configuration. As great as SP-LGC is, it's still not the real thing. Very high purity solid silver is just plain flat-out better. There is even less jitter and the resulting analog simply more believable. In addition to superior metal, VSD-4 also uses a very unique Teflon outer jacket.

Having the best extrudable dielectric as the insulation for the shield gives this cable unparalleled performance. VSD-4 also uses welded silver-plated RCA's.



**AudioQuest Falcon (AES/EBU)** also uses Hard Cell Foam insulated solid SP-LGC conductors. Falcon is a dedicated 110 triple balanced design. Triple balanced means that each of the three "signals" has its own identical low distortion conductor. A super low distortion non-braided silver plated shield is connected to chassis ground through the case of the XLR plugs.

Exceptional AQ#40/41 direct-silver plated FPC XLR plugs help maximize performance.

### CinemaQuest from AudioQuest

Please don't be confused . this is where we switch (for a while) to using the CinemaQuest name. CinemaQuest (CQ) the brand, from AudioQuest (AQ) the designer and manufacturer. CinemaQuest products all have a significant role in Home Cinema . which is much of the purpose of Home Theater. All our many types of cable which carry a picture, are under the CinemaQuest banner. Video is the core of the CQ line. Some CQ products, such as OptiLink 1, 2 and 4, have important applications outside video (CD transport or MiniDisc to DAC). All the AQ brand products are also ideal in a Home Theater. However, the video based world is a little less central to the existence of AQ brand products.

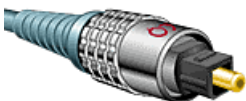

**CinemaQuest OptiLink 1** provides significantly higher performance than is often thought possible with the Toslink interface system. Even though OptiLink 1 has a very modest price, that first step from normal cable into the CQ OptiLink series, is the biggest step . . the most sonic improvement.

CQ OptiLink cables can make so much difference because, when used in a Home Theater system, a Toslink cable is carrying five (5.1 or more) channels of audio information. It is the only single cable that so globally affects the performance. In a two channel application, a Toslink cable is also carrying all the audio information. Performance is equally important no matter the number of channels, but the cable is doing two and half (or more) times the "work" in a Home Theater system.

OptiLink 1 uses a low-loss low-jitter synthetic fiber, a precision machined termination (to minimize dispersion and reflections), a brass ferrule plug, correct cladding (the fiber's intimate covering), and effective mechanical damping (cushioning for the fiber). The result is low distortion and better sound from this reliable cable.



**CinemaQuest OptiLink 2** is better. Just as with OptiLink 1, the performance of OptiLink 2 is dependant on the quality of the ingredients and the execution. OptiLink 2 uses a significantly better optical fiber. When using most digital audio cables, there is very little difference in the sonic signature of the various cables. This is because the signal being distorted is a single digital stream instead of a multiple channels of ten octave wide analog. Since character flaws are rarely a problem, there are very few trade-offs between cables . they are either better or worse, not some of each. A better cable simply passes a more accurate signal: less irritating, more intelligible and articulate, a better three-dimensional panorama . a more emotionally inviting presentation. That is the reason for OptiLink 2.



**CinemaQuest OptiLink 4** is the best. The Toslink story is pretty well described within the above information for OptiLink 1 and 2. OptiLink 4 is the cable at the top. It uses the best of everything, including a fused silica fiber (also referred to as Quartz or Glass). As a result, this cable does less damage. It passes the most complete signal.

## Video Cables

There are four different systems for transferring a video signal. All four systems need low-distortion high-bandwidth 75 cables. The differences are in how many channels of signal need to be carried, and the type of plugs on the end.

Composite video requires a single high quality cable to carry the complete video signal. Standard connectors are either RCA or BNC plugs.

S-Video is a two cable system which carries the two basic parts of a composite signal separately. The black and white picture signal is known as "Y" and the signal containing all the information for decoding the color information is called "C". This explains why the proper name for this system is "Y/C". When color TV was brought to market, it had to be compatible with existing b&w TV sets. The solution was to continue to broadcast a b&w "Y" signal, but to supplement it with a second "C" signal at a higher frequency. This is why broadcast TV and VHS tape recorders are Y/C media. Since an S-VHS tape machine has an "S" (Y/C) output, it gives you direct access to the separate Y and C signals, whether from a tape or from an over-the-air broadcast. "S" outputs on tape machines, cameras, DSS and DVD machines will provide better performance than a composite output. However, the video signal on a LaserDisc is composite. The "S" output on an LD player will only outperform the composite output if the LD player's filters (which separate composite into Y and C) are better than the filters in the TV set.

Component video is the somewhat confusing name for a three wire system which carries the "Y", "I" and "Q" signals. Slightly confusing because the components of a color signal are RGB (see next paragraph). "Y" is that same b&w signal as in Y/C cable (see previous paragraph). "I" and "Q" are the components (get it?) of a "C" signal. In order to derive three colors from a b&w signal, there need to be two color difference signals, I = blue minus Y (add Y and get blue), Q = red minus Y (add Y and get red), and once you have blue and red and Y you can derive green. These three signals need exactly the same care and respect as a composite video signal. Since standard YIQ connections are either RCA or BNC, you can simply use three identical composite video cables, or for convenience use a YIQ cable which has the three joined together. Don't get fooled by some hype about specially designed for component video, either it's a proper video cable or it isn't. When a piece of equipment sources from a YIQ signal, such as DSS and DVD, using a YIQ cable setup will provide superior performance over composite or "S".

**RGB** are the real components of a video signal. This five conductor cable carries the three unadulterated color signals, red, green and blue. The other two cables carry the synchronization information which tells the monitor where a picture starts and ends, and a signal called "burst". The five together give you a complete picture. When you have this option, use it. You'll know who you are.



**CinemaQuest VSD-1** is most often used for composite video, when all the video information is mixed together into a single signal. However, this cable is also a tremendous high performance cable in all 75 applications. The initials stand for Video, Satellite and Digital; just a sampling of the signals this cable was designed to handle with minimum loss and minimum distortion. VSD-1 is simply better, objectively better, than our previous superb Video One cable .



SP-LGC (Silver Plated Long Grain Copper) is a crucial ingredient in VSD-1 (and in most of our wide bandwidth cables). SP-LGC sounds horrible when used for an analog audio signal, but for video and RF it works wonders over even the finest pure coppers. HCF (Hard Cell Foam) is used to insulate the large 19 AWG center conductor because it puts the maximum amount of air around the conductor, and yet HCF is hard enough to guarantee extremely consistent impedance, which is crucial to good high frequency performance.



**CinemaQuest VSD-2** composite cable uses an 18 AWG HCF (Hard Cell Foam) insulated SP-LGC conductor. The larger center conductor along with a combination foil and Silver-Plated LGC shield offers improved performance for both long and short lengths.



**CinemaQuest VSD-4** composite cable uses HCF insulated solid FPS silver conductors in coaxial configuration. As great as SP-LGC is, it's still not the real thing. Very high purity solid silver is just plain flat-out better. Color saturation, definition and contrast are all improved. Welded to silver-plated solid FPC plugs.



**CinemaQuest S-1** uses HCF insulated solid Silver-Plated Long Grain Copper (SP-LGC) conductors in a symmetrical design. S-1 is actually two identical 75 cables, one each for the "Y" and "C" signals which together carry the video information. Each of the two cables uses a symmetrical design: in addition to a foil and braided shield, the ground uses a 22 AWG SP-LGC conductor which is identical to the center conductor.



**CinemaQuest S-2** uses the same extremely effective design as CinemaQuest S-1. The clearer, sharper picture is due to the silver plated shield, which provides superior shielding and lower distortion. All three CinemaQuest S cables have four times as large a conductor as an average S cable. Lengths should still be kept to a minimum, but CQ-S cables can be run in much longer lengths than other S cables.



**CinemaQuest S-4** also uses the same extremely effective design as the CinemaQuest S-1 and S-2. Upgrading to a solid FPS silver center conductor simply makes this the highest performance S-Video cable available.



**CinemaQuest YIQ-1, YIQ-2, YIQ-4** "component" cables are the exact same cables as the three "S" cables described above, except with three channels instead of two. As described in the video system explanation section above, all video transfer systems require "low-distortion high-bandwidth 75 cables". The only difference is how many channels of signal need to be carried. Silver plated RCA or BNC plugs.



**CinemaQuest RGB-1, RGB-2 and RGB-3** also use the same great cable designs as the "S" series. This time there are five delicate signals to transfer from the source to the projector. RGB-1, RGB-2 and RGB-3 get the signal there like no others. Prepared with RCA and BNC connectors.

Video/Satellite/Broadcast Direct Burial Cables



**CinemaQuest VSD-1** is an amazingly versatile cable! The low distortion 19 AWG solid Silver-Plated Long Grain Copper (SP-LGC) center conductor can carry a delicate DSS signal a couple hundred feet. The Hard Cell Foam (HCF) insulation insures minimum dielectric involvement (distortion) whether for multi-room digital distribution, composite video, RF, DSS for any wide bandwidth application. The heavy braided shield and 100% coverage foil insure full protection under adverse conditions. The special outer jacket is fabricated to stand up to the harshest outdoor applications, including being directly buried in the ground.



**CinemaQuest VSD-2** does all the great things VSD-1 does, and it does them even better. The most obvious difference is the Teflon outer jacket. Not only is Teflon a superior dielectric, causing even less distortion, but Teflon makes VSD even more secure against all the dangers of the in-wall, outside, and underground worlds. The braided shield is silver plated for even lower distortion and better conductivity. When the job is to connect top quality equipment, VSD-2 is in a league of its own for getting the job done.

## AC Power Cables

The cable from the wall to the amp, preamp, processor, monitor or other component is subject to many of the same distortion mechanisms as speaker cable. Because it is never stranded, standard in-wall wiring is far better than most power cables, but AudioQuest AC cables are much better than what is in your walls. If you are serious about performance, major improvement is possible by running AudioQuest AC-12 from your circuit breaker box to the outlets in your home entertainment room. Many of the best custom installers now offer this high level of service and performance.

A powerful AQ RF Stopper is attached to preassembled AQ power cords. The RF Stopper is a ferrite tube which significantly attenuates radio frequency interference (RFI). A current can only travel in a conductor when its associated magnetic field can travel in the space outside of the conductor. By disrupting the magnetic field associated with RFI which travels outside the cable, the RF Stopper effectively prevents RFI from being conducted into the equipment. All AQ power cables are UL and CSA rated.



**AudioQuest AC-15** is a 15 AWG x 3 cable using two separate solid 18 AWG LGC conductors for hot, two for neutral and two for earth. AC-15 is flexible and yet has no strand modulation problems. Superior materials and design, plus a powerful RF Stopper explain why this cable is able to provide such a clear performance advantage. UL and CSA.

**AudioQuest EEC-1.6** is the same cable as AC-15, using the legal color code for the European Community. 1.6 refers to the mm<sup>2</sup> cross sectional area of each connection. UL and CSA.



**AudioQuest AC-12** is a 12 AWG x 3 cable using four separate solid 18 AWG OFHC conductors for hot, four for neutral and a 12 AWG stranded conductor for earth. AC 12 is surprisingly flexible considering the serious ingredients inside. Brute force, superior materials and design, plus a powerful RF Stopper, explain why this cable works so very well. UL and CSA.

**AudioQuest EEC-3.3** is the same cable as AC-12, using the legal color code for the European Community. 3.3 refers to the mm<sup>2</sup> cross sectional area of each connection. UL and CSA.

## Installation Speaker Cables



**AudioQuest F-40** is Flat and Flexible. Only 1/12" thick (2 mm) and 3/8" (9.5 mm) wide, F-40 is easy to use, easy to hide and sounds great. Long Grain Copper (LGC) in carefully designed bundles avoids skin-effect and provides superior resolution. 17 AWG (1 mm<sup>2</sup>). Available in white or as FF-4 in black.



**AudioQuest FF-8** is Flat and Flexible, still only 1/12" (2mm) thick, but 5/8" (16 mm) wide. FF-8 uses eight 20 AWG LGC stranded conductors, four for positive and four for negative, making 14 AWG (2.06 mm<sup>2</sup>) x 2. FF-8 is available in white or black.

**FLX 16/2 and FLX 16/4** are UL CL-3 rated Round Flexible speaker cables, specially designed to be very easy to use in a wide variety of applications. The insulation on the conductors is PVC to ensure maximum flexibility and good flame resistance. The outer jacket is a slippery smooth PVC: flexible, easy to pull, installer friendly. FLX cables are printed with sequential feet numbers.



**AudioQuest FLX 16/2** is a very effective 16 AWG (1.23 mm<sup>2</sup>) cable using Long Grain Copper (LGC). Each conductor in FLX 16/2 uses 19 strands of 29 AWG, ensuring that 63% of the strands will be on the surface all the time, where they do the most good. The two conductors are spiraled together to provide good RF rejection and optimum signal carrying capability.



**AudioQuest FLX 16/4** uses 4 of the same conductors found in FLX 16/2. The 4 conductors are separately color coded so that they may be used with two conductors tied together (13 AWG, 2.27 mm<sup>2</sup>) to carry a single channel signal, or separately so one cable can carry two signals.

The **SR** cable series is most unusual because each cable has a 100% coverage shield. Each conductor is tightly held in high temperature PVC and the overall cable is jacketed in a slippery high temperature PVC jacket. This outer jacket is abrasion and heat resistant, and can be used in a variety of harsh environments. The SR-16/2 and SR-16/4 cables sound better than the FLX 16/2 and FLX 16/4, have lower resistance, and are shielded. A tape under the jacket of SR cables is printed with sequential feet numbers.



**AudioQuest SR-15/2** uses 2 spiraled conductors, each with 26 strands of 30 AWG LGC copper (16 AWG, 1.32 mm<sup>2</sup>).



**AudioQuest SR-15/4** uses 4 of the same 26 strand LGC copper conductors coded with 4 colors. When used with 2 conductors for positive and 2 for negative, the superior 4 conductor geometry greatly improves sound quality. In this configuration SR-1604 is a 13 AWG (2.64 mm<sup>2</sup>) cable.



**AudioQuest SR-13/4** uses 4 color coded LGC copper conductors (14 AWG, 2 mm<sup>2</sup>). When used with 2 conductors for positive and 2 for negative, this is an 11 AWG (4 mm<sup>2</sup>) cable.



**AudioQuest CV-4** is a small (0.26") SST Hyperlitz cable using four solid PSC copper conductors; 2 x 20 AWG (0.52 mm<sup>2</sup>) and 2 x 17 AWG (1.02 mm<sup>2</sup>). Overall CV-4 is a 15 AWG (1.54 mm<sup>2</sup>) cable. The dynamics and clarity will rearrange all your cable prejudices. The four conductor geometry provides a superior balance of forces between the opposing conductors.

PSC copper significantly reduces distortion within the conducting material. SST technology reduces cable awareness and allows authority and kick not otherwise possible in such a small cable. Use full range, or as the top half of a biwire combination, or as an ideal single biwire cable in autosound applications.

### Installation Interconnecting Cables

**AudioQuest Sidewinder, Copperhead and Viper** have all been described in the previous main interconnect section. In addition to sounding great, these cables are small, flexible, easy to use and carry a UL CL-3 rating when ordered without the braided "mesh" covering.

### How To Get The Most Performance Out Of Your Cables

Sometimes the cable marketing types do nothing except talk about connectors and terminations. It is a serious mistake to think that connectors (and the way they look) are more important than the cable. It would also be a mistake to ignore the connection interface.

In the section about interconnecting cables we have described AudioQuest's very high quality proprietary RCA and XLR plugs. These plugs make an important contribution to performance—we are proud of them.

Terminations for speaker cable are more complicated, only because there is so much misunderstanding of the very simple priorities. The best connection is what is called a "gas-tight" or "cold weld" connection, formed when the wire and the piece it is connected to have been pushed together with enough force to cause a change in the shape of the materials at the surface where they meet.

When a spade lug is crimped around a group of copper strands, the strands develop flat spots where they touch each other and where they touch the inside of the lug. These flat spots are gas-tight connections. Because they are gas tight they will not oxidize or degrade. If this connection is soldered after crimping, the solder cannot flow into the area where the metal is pressed together. The gas-tight connection will continue to be the primary electrical pathway. If the connection had been soldered before crimping, the solder would be an additional material impeding the electrical pathway and contributing to distortion.

Sometimes speakers and amplifiers have connection facilities that let you really screw down on the incoming wire. If you were to connect a single strand (or two or three strands) directly to such a terminal, you would have an ideal gas tight connection. F-14, Type 2 and Type 4 speaker cables can often be used this way. However, most of the time the cable has too much metal to really make a proper permanent connection without being "prepared" before being connected to the amp or speaker.

Historically, the most common form of "preparing" or "terminating" cable ends has been tinning (soldering). This is still an effective solution for connecting to push-to-connect terminals. The solder will prevent corrosion and the spring action in the push-to-connect will bite into the solder. This method is superior to using hard gold plated machined pins—the round pins offer almost no contact area.

AudioQuest direct-gold plated (#10GP, #14GP) or direct-silver plated (#10SP, #14SP) stamped pins are a suitable alternative to soldering.

Usually a spade lug is the most effective termination for a speaker cable. A spade can be securely attached to a screw terminal or binding post, or one "leg" can be inserted into a push-to-connect terminal. As long as the spade is made from soft copper, it will deform (become marked) where it connects to the screw terminal or binding post. These marks show that there was a gas-tight connection.

Unfortunately, the desire for spade lugs to look and feel "fancy" has resulted in the common use of inferior materials. Most spade lugs are very shiny. This is almost always due to the nickel plating underneath the gold. This nickel layer clearly distorts the sound, but it does make the lug look pretty-very important if you mount them on the wall instead of listening to music through them. All AudioQuest spades, pins, and bananas are direct plated without any intermediary layer to compromise the performance.

The advantages of gold plating are often misunderstood. Gold is not a very good conductor, and as an extra layer of material, it distorts the music. The reason for using gold is that it is a "noble" metal - it does not corrode easily. The only reason for gold on connections is to prevent corrosion. Luckily the distortion caused by gold is a fairly friendly smearing of the sound, as compared to nickel which causes an obnoxious irritation. AudioQuest terminations are available in a choice of thin gold plating (thin for complete protection with minimal distortion), or with thick silver plating for maximum performance.

In addition to inappropriate plating, the other common problem with spade lugs is the nature of the base metal. While pure copper is best, many "fancy" spades are often copper alloys harder and stronger than pure copper, but they don't sound as good.

As an alternative to spade lugs that look better than they sound, AudioQuest makes spade lugs that sound better than they look.

The standard AudioQuest spade is pure soft copper. It isn't very thick and it isn't strong enough for prying nails. It is direct-gold or direct-silver plated for ideal performance. There is nothing between the copper and the gold. It sounds great and it doesn't cost much! What else could you want?

Well, you might want the AudioQuest Premium #P-8 series spades. They are made from LGC, they are thicker than they need to be (you could pry small nails), and they are direct-gold or direct-silver plated. These deluxe spades are also the correct size to fit into terminal strips, and won't short-out your positive and negative binding posts. Silver-plated #P-8 spades are standard on Type 6 and above.

### Don't Forget To Make Clean Connections



Are you about to put that high quality spade lug, RCA plug, or XLR plug into a dirty socket? Actually, not only does the socket on your equipment need cleaning, but even that new plug will benefit from being cleaned. Any contact surface that has been exposed to air is dirty and will perform better if cleaned. AudioQuest just happens to have the solution, the ideal cleaning solution-AudioQuest UltraConnect 2.

Even the simple-sounding subject of contact cleaners is complicated. There are cleaners that leave an oil or "wetting agent" on the metal's surface. There are contact enhancers that don't clean but offer possibly improved signal transfer. Finally, there are cleaners (only a very few) that leave nothing behind.

While we acknowledge the benefits of conventional cleaners and some of the contact enhancers, we have always recommended striving for the cleanest and least contaminated surfaces. We have always said that the ideal electrical contact was one that had just been filed clean. This is not very practical, but ideals are often like that.

The purpose of AQ UltraConnect is to make it practical to have filed-clean surfaces without the file. This extremely high purity (and environmentally approved) fluid scrubs your contacts clean, without having to scrub. Unlike other cleaners, UltraConnect 2 does not contain Freon or any of its cousins.

## Good Signals - Bad Signals

This entire pamphlet has discussed ways to pass an electrical signal as clearly as possible with no filtering. Unfortunately there is often a signal running through your cables that should not be there.

There is a whole category of energy referred to as RFI (Radio Frequency Interference). When RFI gets into your equipment it compromises the circuit's performance, and therefore compromises the sound or picture quality.

Often people assume that if they don't hear a radio station coming over the CD player, they must not have any RFI. This is not necessarily true! In order to hear a radio station (without a tuner) you need to be picking up that particular radio frequency, and you must have some part of your system that rectifies the signal (tunes in the signal and converts it to audio frequencies).

Most RF interference is not demodulated into an audio signal. The real problem is high frequency energy from radio and TV stations, microwaves, radar, CBs and hundreds of other sources, including your own stereo system! CD players must be registered with the FCC (Federal Communications Commission) because they are sources of RFI. The same is true for tuners, TVs and computers.

The problem of RFI is not new, and neither is the most common solution. For decades, circuit designers have used "ferrite beads" around wires to help block RFI. When the "beads" are large, and hinged so that they can open and close, they are called "ferrite clamps".

Ferrite reduces RFI in a cable by disrupting the radio frequency components of the magnetic field outside of the cable. For a current to travel within a cable, there must be an associated magnetic field on the outside. By altering the magnetic field, ferrite is able to filter the current inside the cable even though nothing has been inserted into the cable. No extra connections or electronic parts with their own distortion problems.

**AudioQuest RF Stoppers** are custom designed ferrite clamps. They use the highest quality ferrite available (there are many to choose from), and they are large enough to fit on most audio interconnecting cables and AC power cables. RF Stoppers Sr. are 40% stronger than most other ferrite clamps sold on the audio market.

The size of the RF Stoppers is crucial. If a ferrite clamp is too large - no problem, it still works just as well. However, if a clamp is too small it is useless. If a clamp cannot close completely it simply doesn't work. Even the polish on the facing surfaces is crucial to the RF Stopper's effectiveness.



**AQ RF Stoppers Jr.** have an inner diameter of 9 mm and come in a package of eight. **AQ RF Stoppers Sr.** have an inner diameter of 10 mm and come four to a package. The cost per filtering power is the same for both.

The performance of your system will improve with RF Stoppers on all your power cords, on the output of the CD player and tuner, and on the inputs of the power amplifier. The degree of improvement will depend on the size of your problem, but there is almost always a problem.

Many RF Stoppers are used on cables that don't have much to do with audio. A common one is on refrigerator power cables. Sometimes people hear the sound of the refrigerator turning on through the speakers. In this situation RF Stoppers on the refrigerator's power cable will reduce (not eliminate) the noise.

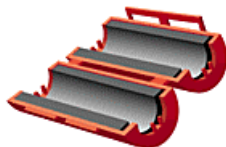

Because they filter very high frequencies so well, do not use RF Stoppers on digital and video cables.

## Evaluation Methodology

How can something as simple as evaluating an audio component require serious thought? Don't you just listen and either there is a difference or there isn't? If there is a difference, isn't one better and one worse?

YES! If you've never thought about equipment.

NO! If you have.

There is a fundamental distinction between listening to music versus listening to equipment. This is definitely the conundrum of our industry: How can one judge the "vehicle's" effectiveness without becoming preoccupied with the vehicle?

The very definition of good audio equipment is that it is not noticed, it is instead listened through. If you view a far off landscape through a window, you would appreciate having a clean and undistorted window to look through. If the task at hand is to judge the usefulness of the window, it is the visibility of the view which must receive the viewer's attention. A valid "test" would determine how much interference was caused by the window. It would be very unproductive for the eyes to focus on the window itself. Focusing on any dirt on the glass would clearly destroy the ability to see and appreciate the view, rendering the "evaluation" meaningless.

An important pitfall to avoid, is paying attention to the equipment, as that destroys one's ability to judge the effectiveness of the equipment. This artificial separation of the equipment from its function is possibly the most fundamental pitfall in the evaluation process.

Despite rampant references to "golden ears" and such, it is the truly inexperienced listener who most easily appreciates differences and is able to establish hierarchy. Ironically, it is listeners with a total absence of technical detail who are most easily able to cut directly to the truth. However, even these fortunate people need an appropriate context for the bare truth to come shining through. There are pitfalls even for virgin ears.

The challenge for most of us immersed in this fabulous world is to reclaim the innocence we once had when we first felt the emotional and sensual thrill of a sound system that was better than we had thought possible. Generally this ear opening experience took place around late adolescence. We then proceed to spend the rest of our lives trying to recreate that experience. The crucial distinction here is between "event" and "experience". The "politically correct" paradigm for audio is to be preoccupied with recreating an event which occurred at another place and time.

To heck with living in the past. Music is about how we feel in the present! The purpose of an audio system (in the real world) is to evoke an emotional response here and now, not to give a history lesson. Even though an audio system might be able to convey whether a recording was made in Carnegie Hall before or after the renovation, it might not be able to convey the pathos and power of the music.

Music and data are not the same thing. If the recording and playback process were perfect, then music and data would be equally well served. However, audio systems are a long, long way from perfect. This vast discrepancy leaves room for some seriously warped priorities - what we call the "tyranny of perceived resolution".

In an attempt to more predictably quantify audio performance, there is an imperative to pay attention to quantifiable values. At its most base level this means measuring and comparing numbers. At the listening level, this quantification fixation often leads to the mono-theistic religion of "resolution at all costs."

In the artificial context of listening to (focusing on) the equipment, any additional "information" creates an imperative to follow that path, to use that equipment. If the purpose of an audio system is to be a vehicle to enable music to stimulate the mind and body, more information should only be one of the gods in a pantheon, not the only god.

For example: If two components are compared, and one presents a fine sounding quartet, but the other one reveals that it is really a quintet, the "politically correct" will immediately and absolutely declare the component conveying the quintet to be superior. However, what if the sound of the "quartet" is enthralling and involving, but the quintet is fatiguing and irritating? Isn't it more important to enjoy the music?

This dichotomy highlights why a system designed for monitoring a recording session is often so different from an entertainment system. Resolution is the purpose of a monitoring system. Sounding good and being enjoyable have little value, hearing what is going on is the whole story.

Besides the danger of listening to equipment instead of music, the next most fundamental challenge to useful evaluation is overcoming the amazing human ability to adapt.

- We are astonishingly capable of "seeing" through distortion. We (generally) don't feel our clothes, yet we are sensitive to even a single rain drop falling on our clothing.

We can wear all colors of sunglasses and yet still see that the sky is blue. If we use yellow goggles while skiing on a cloudy day, when we take them off the snow looks purple. The "solution" isn't to get out the yellow paint to fix the snow, the solution is to allow ourselves time to re-calibrate our references. Once we have adjusted to a colored (distorted) reference, we can be fooled into thinking reality is wrong.

Have you ever been given a cassette tape and you didn't know if it was Dolby encoded or not? You probably pushed the Dolby button on and off, while you were playing the tape, in an attempt to decide which way was correct. Odds are that both positions sounded wrong. One way sounded too bright and the other sounded too dull. In this artificial context one is faced with two conflicting references, both of which make the other sound wrong. A common response is to wish there were a middle position, even though one of the existing positions is absolutely correct and the other is absolutely wrong. This is an example of how an instant comparison can be a highly deceptive selling technique and not part of a trustworthy evaluation methodology.

Whoever controls the switch can sell whatever they want. This also applies to a lone individual doing an "evaluation" by themselves. Just because a second party isn't involved doesn't prevent someone from "selling" themselves whichever component first grabs their attention, whichever one got the good review, whichever one has an attractive story.

- Another simple opportunity for deception (including self-deception) is the A/B phenomenon: The second time a piece of music is played, the listener is bound to notice something that wasn't noticed the first time—even with familiar music. This perception feeds directly into the value system which dictates that more information is our most commanding priority. **If you want to sell something, always play it second.**

There are ways around this pitfall: Go back to "A". No matter which is better, going back to "A" will be a surprise. Since the step from "A" to "B" included the "novelty factor" in addition to the real difference, the step back to "A" will be surprisingly different from the original step to "B", simply because the novelty factor has disappeared. "A" will seem to be better than when played the first time. Continuing on to play "B" a second time, without the benefit of the novelty factor, then reveals its truer relationship to "A". After an initial A/B/A/B, it is possible to move to "C" and "D" with far less confusion.

- **It can be easier to evaluate three products instead of the apparently simpler task of evaluating only two. Even without the deception of an instant A/B, any A/B is subject to a certain amount of the effect described with the cassette tape example - the truth is perceived as somewhere between the two.**

If two of the three products are relatively similar, probably (but not always) different models from the same manufacturer, then it is quite easy to establish an absolute hierarchy between the two products. When a third and different product is compared to a similar pair, it becomes a comparison between a line and a point, instead of just between two points. It becomes much easier to establish a hierarchy: that the third product is preferable to either member of the pair, inferior to either, or somewhere in-between.

- There is almost no way back to the "garden" of complete innocence. It requires great awareness and careful methodology to attain anything like the direct vision available to those who cannot be distracted by misleading details. This view flies in the face of those who declare that people have to learn what is good sound, go to lots of live concerts and study the technology. Bull!

The only thing that needs to be learned is how not to be misled by the incredibly deceptive process of listening to equipment. People hear real sounds all day long. None of these real sounds has the added layers of distortion which exist in every audio system. Whether or not we have ever heard a particular singer or instrument, we can recognize whether more or less "extra stuff" is in the way.

- As for comparisons where there seem to be only "insignificant" differences between components, this is usually proof of a faulty context and/or methodology. This is most obvious in the discussion of ABX testing.

In an ABX set-up, the listener does not know whether or not there has been any equipment change at all. ABX testing is not a question of how a fixed but blind "A" compares to a fixed but blind "B". Because there are too many unknowns, the ABX test becomes primarily an opportunity for embarrassment. Context is everything, and the ABX set-up is one very distorted context, much too far removed from the purpose of an audio system. ABX fans believe that a lack of repeatable hierarchy proves there are no valid differences. **Others of us believe the same evidence proves that the ABX test is an invalid methodology.**

Does all this mean that trustworthy conclusions are impossible? No. It means a balanced perspective is paramount.

It's a little like shopping for advice (which really is more useful than shopping for equipment): If honesty is the sole criterion, you'll probably end up taking advice from someone honest, but incompetent. If competency is the sole criterion you get the picture.

### **Burn This**

We sincerely hope that after you have absorbed some of this information, and after you have set up your music system, you will put on a recording and hear the music, not the equipment. Unfortunately, the very process of being an informed and careful consumer involves at least temporarily increasing your awareness of the equipment. When the evaluation process is over, we hope you can turn it off. Toward that end, burn any print outs of this text, or better yet, give it to a friend.

### **The Final Sell**

There is one more thing AudioQuest does want to remind you about - the AudioQuest Music recording label offers some of the finest artists performing some of the world's greatest music - and they just happen to be superb recordings using the finest studios, tube microphones, cables(!) and lots of loving care.



# Nordost

## TECHNIQUE AND INNOVATION.

Nordost cables excepting the Micro Monofilament and Moonglo products share a common design theme, Solid Core Conductors. Depending on the application, either solid, flat rectangular OFC conductors or fine, round micro litz conductors are used.

By using a precise extrusion of Teflon around the individual conductors we eliminate strand interaction, which significantly reduces the well documented audible distortions caused by skin effect and magnetic field interactions. Nordost cables use extremely precise conductor spacing which keeps the capacitance and inductance at a very low level, resulting in cables which typically transmit signals at over 90% the speed of light. This is 25-30% faster than conventional cables which is audible as a tremendous improvement in musical accuracy and clarity.

Nordost have also developed a new construction technique which dramatically reduces the effect that the cables insulation has on signal transmission. This important development is called Micro Monofilament Technology (patent pending) and is featured in our reference Quattro-Fil interconnects, Silver Shadow digital cable, Optix video cables and El Dorado power cords.

### Flatline



**Flatline Gold MKII** consists of four rectangular 99.9999% OFC conductors (positive and return) per channel. Each conductor is individually encapsulated with 0.5 mm of extruded Teflon. Prior to extrusion each conductor is ultrasonically cleaned to remove all contaminants from its surface.

Flatline Gold is a firm favorite with audiophiles due to its extremely high performance to price ratio. Available in pairs from 2 meters preterminated with Nordosts' 4 mm Z plug, spades or pin connectors.

**SuperFlatline MKII** is a 'doubled' version of Flatline gold, having sixteen conductors to facilitate neat and simple Bi-Wiring, or Bi-Amping where two amplifiers are used to drive one pair of loudspeakers. The cable can also be 'shotgunned' which means that it is terminated with eight conductors for use with higher current amplifiers. Each single conductor of Flatline Gold MKII / Superflatline MKII is capable of carrying 12.5 amps of current.

SuperFlatline MKII is a tremendously popular cable due to its versatility and exceptional performance in both two channel and home theater systems where it is perfect for wiring front, subwoofer and center channels. Combined with Nordost interconnects and Optix video cables Flatline Gold and Superflatline MKII will ensure the finest performance from your home entertainment system.

SPECIFICATIONS.	FLATLINE GOLD MKII	SUPERFLATLINE MKII
Insulation:	Extruded Teflon	Extruded Teflon
Conductors:	x8 Flat Rectangular	x16 Flat Rectangular
Material:	99.9999 % OFC	99.9999% OFC
Capacitance:	8.6 pF / ft	9.7 pF / ft
Inductance:	0.13 $\mu$ H / ft	0.12 $\mu$ H / ft
Propagation Delay:	91 % speed of light	91 % speed of light

## 2 FLAT and 4 FLAT



**2 Flat** is a unique, ultra flat, extruded speaker cable that is thinner than a credit card. It consists of two rectangular, solid OFC conductors extruded with a white Teflon jacket. 2 Flat has very low inductance and capacitance.

The excellent sound quality and low signal loss of 2 Flat make it ideal for both HiFi, and home theater applications where long runs for surround channel speakers are required to be discrete, yet offer high performance.

Its extremely hard wearing Teflon jacket makes it the perfect choice for installation by running under carpets and floor coverings in high traffic areas.

**4 Flat** is identical in construction to 2 Flat but is doubled up to facilitate neat and simple Bi-Wiring / Bi-Amping. With increasingly high performance amplifiers and Bi-Wired loudspeakers being used in home theater systems 4 Flat is the obvious choice for a neat and unobtrusive high quality cable installation.

SPECIFICATIONS	2 FLAT	4 FLAT
Insulation:	Extruded Teflon	Extruded Teflon
Conductors:	x 2 flat rectangular	x 4 flat rectangular
Material:	99.9999% OFC	99.9999% OFC
Capacitance:	7.0 pF / ft	8.0 pF / ft
Inductance:	0.17 $\mu$ H / ft	0.14 $\mu$ H / ft
Propagation Delay:	90% speed of light	90% speed of light

## QUATTRO-FIL Interconnect



The Nordost Quattro-Fil interconnect makes the connection using brand new state of the art technology. Utilising the latest advances in high speed signal transmission, and using Nordosts' brand new Micro Monofilament technology (patent pending), Quattro-Fil has been designed to offer the highest level of resolution, detail and musical performance between line level components.

The interconnect consists of four groups of conductors, each group being made up of seven 99.999999% OFC conductors extruded with 50 microns of high purity silver. Each conductor group is helically wound with a fine Teflon

spacer which has minimal contact with the surface of the conductors, a Teflon tube is extruded over the spacer sealing the conductor group and suspending it in inert air, preventing oxidation.

The four Teflon tubes are then wound around each other and bonded together by a proprietary wrapping technique. A dual layer of silver served shielding is then wound around the assembly. Over this a Teflon outer jacket is then extruded.

The result of this painstaking assembly is a cable which has an incredibly fast signal propagation of 87% the speed of light which is unique for a dual shielded cable design. This design performs music with a new level of realism.

Each interconnect is hand built and is available with Nordosts MoonGlo ground before signal RCA phono plugs or gold XLR connectors. Quattro-Fil is also available as a 1.25M Tonearm lead terminated with a high quality mini 5 pin din to RCA phono plugs.

SPECIFICATIONS	QUATTRO-FIL
Insulation:	Extruded Teflon
Conductor:	4 groups of 7 in Micro Monofilament construction
Material:	50 microns extruded silver over 99.999999% OFC
Capacitance:	12.0 pF / ft
Inductance:	1.38 $\mu$ H
Propagation Delay:	87% speed of light

## Black Knight Interconnect



As the performance of audio components in both HiFi and Audio Visual systems increases, so does the demand for high resolution interconnect cables. Black Knight is designed to meet this need. Consisting of 8 rectangular OFC conductors per channel (4 positive and 4 return) in an extruded Teflon jacket and manufactured to exacting tolerances, Black Knight offers extremely low resistance and signal loss giving greater detail, clarity and transparency in all applications.

A perennial favorite which offers superb performance at a budget price.

Black Knight is also available terminated with balanced XLR connectors.

<b>SPECIFICATIONS</b>	<b>Black Knight</b>
Insulation:	Extruded Teflon
Conductor:	x8 Flat rectangular
Material:	99.9999% OFC
Capacitance:	8.6 pF / ft
Inductance:	0.13 $\mu$ H / ft
Propagation Delay:	91% speed of light

## Carbon & Hybrid Technology

First a short discussion on metal conductors and their vulnerabilities:

Due to the current cable manufacturing processes based on economics and aging, all metal conductors are sensitive to growing chemical boundaries at the edges of their internal crystals.

**These chemical boundaries form non-linear conductive barriers for the electrical signal to be transferred.**

The main reason for the origination of these chemical boundaries is the rough industrial handling of the basic material during the manufacturing of the single leads by pulling the metal through many dies and the unprotected storage in between. Especially the bare storage of the drawn wires on reels in the open air creates another problem: chemical interaction with airborne reactive components and their subsequent deeper propagation into the metal during the next processing steps.

As you can imagine, the result is that the final conductor still looks like a conductor, but on microscale does not exactly behave like one anymore.

There is no continuous and stable/predictable conductive medium from the begin to the end of e.g. an audio cable. Thanks to the mechanical and (even unknown) chemical treatment of the product during manufacturing, but also its handling and storage afterwards, in the mean time a lot of new crystal boundary contamination will have sneaked its way into the metal, this causing all kinds of audible side-effects like sonic harshness and masking of spatial information.

I have named this: Cross Crystal Distortion (CCD).

The size of the crystals in general after production will range from big (around max. 1 mm.) to small (like 100  $\mu\text{m}$ .). The more crystals, the higher the number of crystal boundaries and the stronger the CCD effect.

This is the main reason why metal conductors (especially audio cables) age and with it change their sound character.

It's man's eternal task to rework (recycle) waste to the actual highest standard; and the whole process starts again.

Forgetting the aspect of recycling for a while, the practical effect for an audio freak is that he has to renew his cables every once in a while. This is the result of his (mostly unconscious) awareness of the cable's growing harshness and fading detailedness. **The smooth detail is replaced by the artificial harmonic distortion caused by CCD. In some occasions this would just be the effect audio-freaks are looking for.**

Therefore around the world we see some different lines of products produced with the simple reason to match these differences in "audio taste".

Impurities in the basic metal, copper or silver, will act as trigger points for growing CCD inside the (cable) product.

### **Q: What generates the typical mechanical defects in a metal conductor like e.g. a copper cable?**

A: During the production of the conductor there is a lot of mechanical processing like stretching and bending. Any bending causes minute surface cracks to appear at the outer side- and displacements on the inner side of the curvature. Each break or displacement exposes metal crystal boundaries to reaction with gases from the air (e.g. Oxygen). So there is an outer layer full with impurities (like metal-oxides), non-continuous structures and dislocations. Afterwards it is a miracle that there is still conductivity left.

### **Q: What are the sonic effects of these defects?**

A: As soon as a conductor is not a uniform material, each zone or layer has its own electrical influence on the sound. Especially at lower signal levels, there is a growing influence (the aging effect) on the transmission of the electrical signals (music).

The result is that especially the spatial information drops out and gets replaced by harshness.

### **Q: What causes this so called "harshness"?**

A: The harshness is the result of the abrupt raise in the electrical impedance caused by the growing lack of conductivity at lower signal levels. Very low level sinewaves (tones in the audio signal) e.g. will experience zero crossing nonlinearities and due to this will be supplemented with a rich quantity of (unnatural) harmonics. The zero crossing parts of the sinewave perish since there the signal does not have enough energy to take the (polluted) crystal barriers.

**Q: Is there any difference between e.g. copper and silver conductors besides their color and price?**

A: In principle the answer is NO. But despite this NO there are some differences in the processing. Silver costs a lot more than copper, so the general production attitude is more careful and the production speed is lower: less meters per second, resulting in a reduced mechanical and chemical aging. Sonically this works towards a better signal quality transmitted along the product. The influence of air and bending on the product after its manufacture is about the same as copper, so the aging in a listening room is not different.

Only when the owner is very careful with the product (no bending and a clean atmosphere) the cable will sonically "live" longer.

The crystal structure of e.g. copper and silver is equal and their number of free electrons per volume are about the same. So their typical resistance is equivalent, should this property be important to you.

**Q: Is there a difference between various conductors on an atomic scale?**

A: Yes indeed. The differences on atomic and crystal scale among various metals give rise to their distinct physical properties like hardness, ductility and electrical conductivity. The conductivity being determined by the amount of free electrons available per volume and their freedom to move along the atomic grid.

Especially the electrical current's freedom of movement is impeded by all kinds of structural disturbances like crystal (grain) boundaries which give rise to increased and signal dependent electrical resistivity.

Regarding audio applications it is therefore important to work with conductor materials which exhibit and maintain an as little disturbed structure as possible.

**Q: Does a higher resistance influence the sound quality?**

A: It is not so much the value of the resistance but rather its quality that is important. A stable resistance of the conductor is much more welcome than a resistance depending on the level of the passing signal. In the first situation the sound quality is ok. In the last situation again we get a strong CCD effect, and the sonic result is a signal dependent harshness and a lack of detail, the latter replaced by non coherent harmonic distortion. The non coherent character is related to the harmonic structure of the music.

**Q: Can different metals be combined to produce a good sound?**

A: As long as each metal more or less has the same defects, the result will not be better compared to a single metal construction.

Conductors made of copper, brass and silver to reproduce the sound of a brass band is a nice idea but nothing more than that.

**Q: What is the influence of coating copper conductors with a silver layer?**

A: This depends on the way the coating is achieved. When the coating is done by e.g. electro plating in a liquid containing silver ions (a bath containing a dissolved salt of silver and other chemicals), residual components of the carrier liquid will remain between the growing silver crystals.

This unpredictable "soup" will immediately start chemical activity in any wet or humid environment. So instead of the noble silver forming a protective layer, the copper is surrounded by a chemical unfriendly environment; the result is that the copper conductor will age much faster. The sonic result is extra attention on high frequencies with an unnatural character caused by extra CCD.

So cables coated with silver by an electroplating process will never sound better than their plain copper.

**Q: Are there any good solutions?**

A: Yes there are. Coating metal by means of mechanical processing like cladding is a solution when we think about pure metal cables. So mechanically silver or gold plating a copper conductor is the best solution, besides of course a very good electrical (non PVC) isolating jacket applied immediately after the last die.

Another very good solution is vacuum sputtering a silver or gold layer on a very pure copper conductor. But this is a costly operation.

Our company has products in its program which are manufactured after these principles. Both by the industry and hi-fi lovers they are evaluated as sonically very superior.

Especially our SCS series of multistrand single leads (like e.g. SCS - 2, SCS - 4, SCS - 6, SCS -12, SCS - 6, SCS - 18 and SCS - 28 M) are typical products made according to this philosophy.

The regular "wet" electroplating can still be improved by adding extra process steps like ultrasonic cleaning in distilled water after each production run. The distilled water must be replenished frequently, otherwise the ion contamination effect will remain.

In our program we have products like the CS - 10, CS - 12, CS - 16 and CS - 18 which are manufactured with this production idea in mind.

It is very important that during the electroplating process the copper is not bent or stretched; this highly reduces the absorption of ion residues in gaps on the outer surface. In this manner the extra fast aging due to this absorption is prevented. In our production procedure a lot of attention is paid to this typical manufacturing aspect.

**Q: Are there other practical solutions?**

A: Yes, just forget metals. As long as metals are selected for the practical reason that they are cheap and easy to work with, all problems involved are induced over and over again, despite all extra efforts involved.

**Q: What other materials can be used as conductor?**

A: After a lot of research our solution is non-metallic: very pure strings of carbon-saturated fibers.

With this material there are many advantages compared to any metal.

The mechanical aging is finished because the type of carbon structure used by van den Hul is, by its size already (each fiber is 6 micron thick), insensitive to bending.

Metal conductors used in audio have a minimum diameter of 25 micron and often are much thicker.

The mechanical strength is such that e.g. pulling the fibers will not cause any internal displacements or boundaries.

The carbon structure we use is also thermally completely stable. Even at temperatures of 2000° Centigrade there is no chemical activity like the production of CO or CO<sub>2</sub>.

Also there is no interaction with any chemical known so far. Under standard conditions of audio use this means that the lifespan is unlimited without the material changing its structure or properties.

**Q: How is this carbon material called?**

A: We call it Linear Structured Carbon or LSC

Linear, because the electrical output signal is exactly the same as the original input signal.

Structured, because the carbon's atomic grid structure is defined by the processing of the basic material.

This is a special property because the carbon normally used in the audio industry is based on random orientated carbon powder.

**Q: What is this material made of?**

A: We start with very pure carbon, and thanks to a special processing we are able to line-up all carbon atoms in one big molecule without any boundaries or barriers.

**Q: How does this LSC behave electrical?**

A: Very superior compared to metals:

Each of the 6 micron thick fibers has its own electrical insulation. The common effect with multistrand metal conductors is that electrons can also go from strand to strand and with that cross many more boundaries.

Our individually insulated fibers do not exhibit that effect; electrical signals entering a fiber come out of the same fiber.

Thanks to the stable structure of the LSC, mechanical aging and chemical pollution/deterioration are finished for ever. The carbon atoms are very tightly (and therefore stable) positioned in the LSC's atomic grid.

The electrical impedance is independent of signal level. So the typical addition of harmonics due to CCD is past history. This directly implies a much higher acoustical resolution on very low signal levels.

**Q: Are there any patents involved with LSC?**

A: Yes, in many countries we own patents to protect our unique position with LSC.

**Q: How does LSC “sound”?**

A: When applied as an audio product, the “sound” is more natural and detailed compared to any metal cable.

The transfer of spatial information is strongly improved and the (with metals) typical distortion on the high frequencies makes way for a very natural and mild character, equivalent to live sound.

The often required hi-fi qualities in a soundsystem with extra pitch are out. Back is fatigue-free listening!

This fatigue-free listening originates from the fact that with LSC all frequencies stay in phase and maintain their harmonic structure. The brain does not need to filter-out or rework the (with metals) extra unnatural harmonics.

**Q: Is there any problem with so called “Time Delay”?**

A: There is no problem at all. The random woven individually electrically insulated fibers all have the same length. The typical “Skin Effect”, commercially often used as an argument by cable manufacturers, does not exist with this material (LSC). Also, signal reflections caused by eventual impedance mismatch at a LSC cable’s terminals are effectively dealt with: the individual LSC fibre’s resistive properties bring about an excellent reflection damping.

All our products made from LSC are essentially free from timesmear and/or time delay.

**Q: LSC exhibits a higher electrical resistance compared to e.g. copper. Are there any disadvantages?**

A: The higher resistance of LSC is its only minor disadvantage. From all materials we know, LSC exhibits the best balance in mechanical, chemical and electrical stability. So we have accepted its somewhat higher resistance as the only minor property we have to live with.

LSC’s higher resistance produces only a minor disadvantage in low impedance circuits where it causes a small signal attenuation. When the source impedance of a preamplifier e.g. is 100  $\Omega$  and the input impedance of the power amplifier e.g. is 50 k $\Omega$ , a 3 meter length of our cable The SECOND in balanced configuration will cause a mere attenuation of 0.037 dB itself.

Compared to the much bigger unbalance of volume-controls we can ignore this figure.

**Q: How does one make an electrical connection to LSC fibers?**

A: At the moment we do this mechanically. First all individual fibers are de-insulated using a solution of acetone and an other agent. After this process we clamp the group of fibers in special made small connectors which subsequently are soldered into the final audio connector.

**Q: Does this extra electrical connection affect the sound quality?**

A: We use very high quality copper with a pure 24 carat gold plating, the best there is out of the traditional world. The total length of the fibers crimped into these small connectors is 1 mm. for both ends together. A standard cable is around 1 meter or longer, so only 1 per mill of the total length is in direct contact with the metal.

The small end-connectors are pressed rather flat, so many fibers of the total 12.000 are in direct contact with the clip’s soft gold layer. This involves hardly any “take-over” impedance and therefore also no transmission losses.

**Q: What products in your audio cable range make use of pure LSC at the moment?**

A: In our current program we have five cables carrying the names:

The FIRST , The FIRST Ultimate, The FIRST Metal Screen, The SECOND and The THIRD .

The FIRST is a coaxial (single ended) construction with 12.000 fibers in its core and 38.000 fibers as its screen. It was, as the name already indicates, our first product with LSC, originating from August 1993. Because of the resistive character of the product it also works well as a digital cable (see ARTICLE about this).

The reason of this is that the natural damping of the center group prevents standing waves (signal reflections), so the decoder (in the Digital to Analog Converter DAC) has no problems with the clock recovery. The characteristic impedance of The FIRST is 110  $\Omega$  at 10 MHz and 90  $\Omega$  at 40 MHz, so the transmission of higher frequencies is somewhat easier, compensating for initial losses and meanwhile sharpening the digital interface signal's edges.

Thanks to the pure LSC construction of The FIRST it is the best example of quality transmission available in interlinks.

A small hint: don't use The FIRST in combination with valve power amplifiers with power transformers that radiate strong magnetic fields; this will cause minor hum problems. The FIRST's shield resistance is 14  $\Omega$ /m instead of the (with metal cables) usual 0.01  $\Omega$ .

The FIRST's outer jacket is made of HULLIFLEX , a superior halogen free insulation material without any electrical dipoles.

The FIRST Ultimate is a threefold heavier shielded version of The FIRST .

The FIRST Ultimate's outer braiding, functioning as screen and signal return, is made of 6 (instead of 2) layers of braided LSC fibres. Exhibiting all excellent qualities as found in The FIRST at a much reduced shield resistance, its susceptibility to hum is very low. The FIRST Ultimate therefore is applicable in the most demanding analog and digital audio applications.

The FIRST Metal Screen has the same basic construction as our The FIRST but is additionally equipped with a metal shield. The FIRST Metal Screen with its extremely low shield resistance has been specially designed for those situations where excessive ground currents flowing through the cable shield are present (e.g. with some tube equipment), in complex grounding situations and/or where extra shielding against strong external electrical interference is required (e.g. in highly electrical noise polluted areas). As such The FIRST Metal Screen is especially suited as an interconnect between (or to or from) tube equipment, for transport of weak signals such as from phono cartridges, microphones or musical instruments and as a long length interconnect for all situations.

The SECOND is a balanced cable with two separate center groups, each made of 12.000 LSC fibers. Its shield is made of 4 layers: two layers of high quality silver coated copper and two extra layers with LSC saturated foil in direct contact with the two metal layers. The outer jacket again is made of HULLIFLEX ; a chemically completely inert and impenetrable material without any halogens.

Especially as a microphone (or even electrical instrument) cable, The SECOND performs outstandingly due to the lack of CCD. The very low signal levels cannot be deformed by any mechanical or chemical defects (as being possible with metals) since LSC doesn't contain any of these.

The THIRD is our latest pure LSC product. It is a 3.5 million LSC fiber constructed single lead made for loudspeaker connections. The typical resistance 0.07  $\Omega$ /m. Sonically its qualities are simply unsurpassed.

**Q: Are there other applications for LSC in e.g. audio cables?**

A: Yes there are. At the moment the major part of our regular metal cable products have been upgraded with extra conductive layers containing LSC.

We name them Hybrids since they combine both metal and LSC.

Here, each of the original metal conductors has an extra black coat of LSC saturated material. The saturation is such that the coat exhibits a relative good electrical conductivity. The LSC saturated layer surrounding the metal groups of e.g. a loudspeaker cable is responsible for electrically bridging the minor defects that to a certain amount always remain in metal conductors. The origins of these defects have already been discussed earlier in this paper. The hybrid layer acts as an outer surface impedance controller, so CCD effects are smoothed and the result is a sound quality close to that of our pure LSC cables.

A second complex effect is that radiated magnetic fields in a way are transformed to an electrical current again within the higher impedant conductive layer.

The third positive effect is that the metal conductors are completely sealed from exposure to air. Normally each multistrand metal cable is open to air penetration; with a hybrid jacket there is no further aging by polluted air.

All these aspects together result into a spectacular sonic improvement.

**Q: Does LSC have any other advantages?**

A: Yes. LSC can be recycled for 100%, so cables like The FIRST can be cut, milled and thermally treated to obtain e.g. the coat used in our hybrid products.



**Q: What further improvements can be expected with LSC?**

A: At the moment we are coating individual metal strands with LSC to further improve the sound quality. Our first cable with this special technology will be named the D - 202 HYBRID.

**Q: Does a LSC cable require a burn-in period?**

A: From the theoretical point of view the answer is No. But despite this answer, the settlement of the conductive structure needs some time. In many cases (according to the practical experience of many users) one hour is enough to bring out the full sonic potential.

**Q: Are there any other technical applications for LSC?**

A: Yes, there are many. One of the most interesting applications is supported by the facts that LSC can hardly be destroyed by high temperatures and shows no bending fatigue, so e.g. the coil and the lead-in wires of a tweeter can be made from LSC.

Also electromagnetic shields used in digital equipment can be made from LSC to absorb radiated HF energy. Regarding jitter induced distortion, the timing in digital audio circuitry is very important; any absorption of (radiated) signals without reflections is very beneficial.

Regarding LSC's lack of bending fatigue, another great application (e.g. with our CC - 18 LSC wire) is the use as conductor in robots and medical applications where many movements must be made without failure of the electrical conductors; again LSC is the answer.

Do not hesitate to contact us if you are interested in any of these applications.

**Q: Does LSC have any environmental advantages?**

A: Yes there are many. To mention a few: The material maintains very stable properties during a much longer lifespan compared to metal conductors, therefore regular replacement is past history. This means lower energy consumption and metal sources are relieved from producing high volumes of copper cable.

So the total quantity of material to be recycled can be reduced, especially when LSC finds more applications in the industry. From now on we can save our resources and leave the metal in the mines for next generations. The demand for metal as a conductor can be reduced and as a reward the signal transmission quality is improved.

Also LSC is a completely inert non-toxic material. Copper in contrast is toxic in many of its chemical compounds.

So some investment in LSC applications even helps to bring us a cleaner world.

**The Fusion Series**

As a result of our always continuing research to find technically better solutions, it is a pleasure to introduce our "Fusion Series".

The "Fusion Series" is a new class of cables manufactured with a totally new conductor type based on a very innovative production technology which combines several advanced processes;

We start with extremely pure copper, zinc and silver which we bring in a vacuum oven.

The first step is the evaporation of these three different metals in a vacuum where, due to a strong electrical focusing field, all three metals' atoms are integrated in the centre. The mechanical result of this process already is a physical wire with a 150 micron diameter.

The quantities of each of the three metals applied in this process are under rigorous control to produce a very stable product.

The next step is an ultra high inductive heating which brings about a complete fusion of the copper, zinc and silver.

Immediately (within milliseconds) we apply an ultra fast cooling, causing the final alloy to settle into a totally amorphous state (\*).

\*: Amorphous alloys are produced by rapid solidification of molten metals at cooling rates of about a million degrees centigrade per second. The alloys solidify before the atoms have a chance to segregate or crystallize. The result is a metal alloy with a glass-like atomic structure; a non-crystalline frozen liquid.

All this complex technical processing results into a shiny gold-coloured conductor with an amorphous structure that is free from intercrystalline boundaries.

Whereas intercrystalline boundaries are directly responsible for extra sonic harshness and rich harmonic structures found in recording and reproduction, any cable designed under our “Fusion Series” is free from these very common mechanical defects and their directly related sonic deficiencies.

Compared to any regular metal cable the highest musical resolution possible now has been achieved!

Our company is very proud to be the originator of this new “Fusion Technology” conductor material and to introduce a new class of cable products based on it.

We expect a long-term effect of the “Fusion Series” on the world audio market.

If you have the opportunity, please give the products designed with our “Fusion Technology” a serious listening test!

### **How your house’s brick walls can teach you something about cables.**

Your house’s brick walls are made from a collection of bricks of reasonably equal dimensions, built together with cement. The walls are entirely rigid, this undoubtedly to your and your house companions’ great appreciation.

Cables in essence do not deviate that much from this picture.

Here we also have a collection of parts that among others are connected by means of so called “van der Waals forces”.

When observing metals in cables these “parts” are named crystals and, instead of cement (in your brick walls), we are dealing with their boundary surfaces. These edge surfaces originate from the cable’s production and especially from the time elapsed afterwards.

The production process of conductors involves massive forces on the metal wire and long waiting stops, the latter during which the bare metal remains exposed to the (polluted) open air.

Both mentioned forces and air exposure have quite an influence:

In addition to the mechanically induced formation of new edge surfaces and crystal defects during production, the wire’s crystal boundaries during its bare storage and processing are most prone to chemical reaction with oxygen and other airborne chemical compounds which forms chemical layers on the crystal edges.

This affects all metals; those that are closer to the noble metals in the periodic system of elements to a lesser amount than those that are more remote.

A metal suitable to be used as the conductor in e.g. an audio cable would be rather soft, pliable and ductile, have a low specific resistance, be quite insensitive to corrosion (noble) and be available in large enough amounts (price): regarding its good balance between all properties, of all metals, copper is the most commonly used electrical conductor.

### **Your environment’s and your own influence on your cables:**

Copper is a reasonably suited material since it is soft, quite tough and has a low specific resistance. The formation of internal boundary surfaces due to mechanical and chemical effects however is unfavourable. As a result, the initial quality of signal transfer does not stay forever, but rather is influenced by all kinds of environmental and handling factors.

And this is just where the shoe pinches.

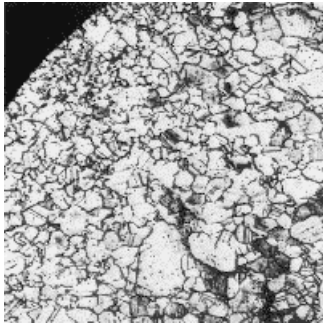

Cross section of a copper wire heavily broken down by bending and chemical corrosion: Severe damage and crystal boundary contamination are discernible.

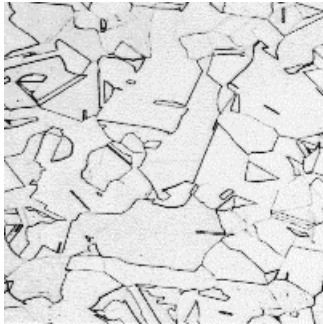

Cross section of an oxygen free pure copper wire as normally found in audio cables: Individual crystals and their boundaries are clearly visible.

Stating that a cable wouldn't have any influence on sound at all would be the same as saying "I don't care what colour my glasses are; all colours always look equally natural to me".

Or: "I don't care how thick (and long) my garden hose is; the garden sprinkler always works equally well".

From your experience you probably don't agree with these statements.

With the earlier given explanation on important parameters, by now you know that also with audio cables differences are to be expected.

The audio signal transfer through a cable for its most important part is determined by the conductor's properties. With metal conductors besides that, the cable design and insulation materials used clearly take a second role.

With perfect conductors (hence in principle not with metals) latter two aspects suddenly do become important.

### **The world's best cable:**

The ideal audio signal transmission in a cable can only take place through a material totally clear of internal boundary surfaces where the material neither has mechanical or chemical decline present nor has these encroaching with time.

Your undoubtedly very fine first bike has gone through rust and metal fatigue. And the several cars you may have had during your colourful existence due to same causes also already have ended at the iron foundry.

In their signal transmission behaviour, cables are much more critical than the conductive properties of your old bicycles.

Signals below -100 dB are important in determining the spatial definition in a recording.

With a bad cable these signals are at risk and/or decline into distortion. The harmonic structure is altered, producing more listening fatigue than listening pleasure.

### **The way many people listen:**

With room reproduction in our country it is a custom not so much to refer to reality but rather to strive for one's own sound image. This including further attempts to "dot the i's and cross the t's" of this idealised image by means of swapping components. With this, cables often are used as the "pepper and salt"; the flavourers and taste enhancers.

Nobody can hold this against you, but when using these flavourers to a considerable amount and, above all, in an unconscious manner, it wouldn't be right to boldly deny having touched ye olde salt and pepper set.

Now you know what the consequences can be, it counts to retrieve the trail, realising yourself what truly counts.

## **Terminology:**

Time (delay) compensation (an in connection with cables often used word) would only matter when you would be able to hear music up to at least 10 MHz. With common audio signals (and a common speed of propagation of the electrical signal in a cable of 200,000 km/s), a single degree phase shift more or less does not matter. After all, your audio signal traverses 1 meter in 1/2,000,000,000 of a second, which is 5 ns. Within the same time span in air, sound covers a distance of only 1.72 micrometer. There are still listeners thinking they can detect this, whereas their ears may be as much as 1 mm. out of the straight with their eardrums 4.5 mm. in diameter and positioned at 45° angles. And what to think of your loudspeakers? Their distance to you often is unequal by more than 1 mm.

By the way: 1.72  $\mu\text{m}$  is the 1/581-th part of a mm. Therefore you don't have to worry too much about that anymore.

Likewise, the so called oxygen free kinds of copper are a nice and fine finding. However . . ., the copper concerned was only free of oxygen during its production. At your home this for a long time isn't the case anymore. Only the printing on the cable stating "Oxygen Free Copper" still might be free of oxygen.

## **How do we deal with our cables:**

Electrical signal transfer does not differ that much amongst the metal conductors. What it comes down to is how the material has been treated during its production.

Likewise, the qualities of the insulation material are of large importance; When the isolation can be penetrated by all kinds of (atmospheric) pollutants (this for instance is the case with the often used PVC) you still have not made a progress.

Only with sufficient care from the manufacturer, the retailer and yourself (and this goes to great lengths), factors like layout and insulation become important parameters again.

It is of direct importance that you take care that your cable connectors are clean enough. With this you avoid boundary layer problems of the same nature as with the earlier discussed crystal edges. Once a month disconnecting all RCA type connectors and, after turning them around a bit in the contra connector, pressing them in again, directly has more effect.

Likewise, keeping your loudspeaker cable connectors clean saves you a lot of annoying sound in the long run.

[At this point we would like to bring the existence of our contact treatment and protection fluid The SOLUTION to your attention.]

Connecting expensive (and especially very thick) cables, in which very thin and often also bad quality mounting wire is applied, to loudspeakers, would be the same as mounting a very thick garden hose to a garden sprinkler with a very small entry opening.

Just drilling out the entry opening a little suddenly causes the entire garden to be a lot more colourful; internally rewiring the entire loudspeaker cabinet all of a sudden causes the same effect.

Sometimes a good combination of listening and active engagement in your audio hobby can lead to amazingly improved results.

May this article have handed you some ideas to that effect.

## DESIGNER TIPS

If you are using high quality cables in your system, longer interconnects and shorter loudspeaker cables produce the best sound quality. If you're using lesser quality cables it's the other way round, short interconnects and longer speaker cables being the best combination. This because the greatest signal (quality) loss is at the lowest levels, rather than at speaker level.

Your best cables must be used for the lowest signal levels, for instance those going from your CD player to your amplifier, rather than from your amp to your speakers. Also, avoid excessive lengths of interconnect or speaker cable.

Keep you male and female cable connectors as clean as possible and use a good contact protection fluid e.g. like our The SOLUTION regularly. Also unplug and re-plug your connectors every month.

Bi or triamping produces the best sound with speakers that allow this sort of connection, though biwiring already is a big step in the right direction.

Reduce ground loops as much as possible and use a polarity checker with read out display to connect all your equipment's mains plugs in the polarity position that produces the lowest hum voltage residual. Each unit of your hi-fi system must be optimised without any other equipment connected. The result after connecting all your equipment together again is a cleaner and for sure more spacious sound.

Do not pile your components on top of each other, instead put the units next to each other. This way there will be less interference between the components, which can have a detrimental effect on performance.

### TIPS & HINTS (Designer Tips 2)

#### Van den Hul cable length markers:

Measuring cable lengths is easy since all our cables are marked with a brand and type name printing every 25 cm. (10 inches).

#### Cable life and bending:

Try to avoid sharp bends in - or often bending of - any of our metal cables. Heavy and frequent bending induces a change in the conductors crystalline structure by displacement and fracture of their metal crystals. This gives rise to increased Cross Crystal Distortion (CCD), causing your audio system to gradually loose its natural clarity and start to sound harsh.

Although in our HYBRID cables the metal conductors are embedded in a Linear Structured Carbon layer which is able to bridge crystal defects, it is of course still advisable to handle your cables with care.

If you mount connectors to our cables yourself:

To prevent mechanical damage to the conductors, whenever possible strip your cables with a thermal stripper, for example your soldering device.

The optimal soldering temperature is around 260° Centigrade (around 500° Fahrenheit). A lower temperature will make a cold (brittle) joint, while higher temperatures will give you oxidized solder. Soldering should be a matter of seconds, not minutes.

After you have made the soldered joint, wait 5 seconds longer than normal and don't move anything. This will make sure that your joints are made well and will last longer.

When available, use silver-saturated solder (commercially available Tin/Lead/Silver (Sn/Pb/Ag) types with a 2 to 5.8 % silver content). Or, if you can afford it, replace the tip of your soldering device with a silver tip; This way it is guaranteed that your solder is always 100% silver saturated.

Solder at the right temperature and don't apply heat too long else the cable conductors' insulation will melt. This increases the risk of a short circuit occurring anytime during the cable's life.

**Please note:**

Our HYBRID type interconnects use Linear Structured Carbon inside the cable which, when incorrectly assembled, can cause an (intermittent) low ohmic short circuit inside the connectors. This can give rise to all sorts of noise, loss of sound, distortion or coloration. When mounting connectors to our HYBRID type interconnects therefore make sure that:

The black Linear Structured Carbon layer covering all internal conductors is removed so that it can not cause any low ohmic short circuit.

The cable shield contains black conductive helically wound tape, which when not removed at the ends may also cause a low ohmic short circuit inside the connectors.

When having mounted a connector always verify with an Ohmmeter that the resistance between any contact combination on the connector measures "infinite" (open circuit). Slightly twist/bend the cable near the connectors when performing this tests to also verify that no movement can induce a short circuit.

**Close the cable ends as much as you can to avoid air penetration.** In the industrial world all air is polluted with corrosive gases. Due to each day's temperature variations the contaminated air tends to flow in and out of your cables where in the long term it can do harm to your audio quality.

We use the best jacket and insulation materials available, and the silver coating on our cable's strands makes an excellent protective shield. But prevention is always better than replacement.

RCA connector terminated multicore cables: shield grounding:

All our screened twin core, quadruple core and triaxial (i.e. balanced) interconnects that are ready-made with RCA type connectors for unbalanced/asymmetric signal transport have their shield connected to the RCA connector's shell (=ground) at ONE side of the cable only.

In connecting the shield to ground only at one side of the cable and lifting it at the other side it functions as a true screen: It does not carry any audio signal; It screens the inner conductors and drains away unwanted noise to one location.

The location at which the cable shield is connected to the RCA connector's shell (=ground) generally is chosen to be at the signal source, however in few cases better shielding performance can be obtained by reversing the cable, thus grounding the shield at the signal receiving side.

When reading the "Van den Hul" printing on our ready-made RCA connector terminated multicore cable types from left to right, the grounded side of the shield is at the left hand side connector. Additionally, (as from May '99) we have marked the grounded side of the shield with a special sticker. This side of the cable needs to be connected to the signal source.

If you wish to mount RCA type connectors to one of our multicore interconnects yourself we advise you to use the same system; i.e. connect the shield to the RCA connector's shell (=ground) only at the "Van" side of the cable's "Van den Hul" printing and leave the shield disconnected at the "Hul" side.

**Connectors:** Clean metal contacts with our RCA type connectors:

All our male RCA type connectors have a cut in the centre pin and multiple cuts in their ground contact shell. Rotating them in the female connector every once in a while and when you plug them in cleans the contacts and will collect the removed dirt in the connector's slots. From now on you can always work with clean metal contacts.

**Connectors:** Contact treatment and protection fluid:

Use a protection fluid like our The SOLUTION to coat your audio, digital audio and video connectors' contacts. Since this fluid allows no chemical actions to take place it prevents your contacts from oxidizing or getting dirty. Furthermore, by lubricating the contact surfaces subtraction and insertion wear on the connector's precious metals is reduced. Both properties help to maintain high quality signal transfer for a long period of time.

**Interconnect versus loudspeaker cable length:**

If you are using high quality cables in your system, longer interconnects and shorter loudspeaker cables produce the best sound quality. If you're using lesser quality cables it's the other way round, short interconnects and longer speaker cables being the best combination. This because the greatest signal (quality) loss is at the lowest levels, rather than at speaker level.

### **Loudspeaker cable general advice:**

It is advised to have your left and right channel's loudspeaker cables of equal length; This way the cable's impedance is the same for both channels.

It is better to run your loudspeaker cables as straight as possible from amp to speaker; Avoid loops and meander excessive lengths.

Whenever possible keep your loudspeaker cables (but also your interconnects!) separated by some distance (at least 10 cm. (4")) from your mains cabling. Also avoid running your audio wiring in parallel with your mains cabling.

### **Loudspeaker biwiring and biamping cable advise:**

Biwiring is advisable. Because the production quality of our twin-lead loudspeaker cables is very consistent, we advise you to combine for example The MAGNUM HYBRID with the D-352 HYBRID or the CS-122 HYBRID.

The D - 352 HYBRID can be combined very well with the CS - 122 HYBRID, The ROYAL JADE HYBRID or The CLEARWATER.

In our product range we however also have special quadruple lead biwiring loudspeaker cables available.

When biamping our above mentioned cable types of course are also equally applicable.

When biwiring always make a good electrical connection between the two cables at the power amp end and if possible solder them together.

When biwiring or biamping keep the two different twin-leads separated by some distance to minimize their mutual electric interaction.

### **Loudspeaker cable connections:**

The contact resistance (and its linearity) occurring at your loudspeaker and amplifier's terminals is an often overlooked point. The contact resistance of bad connections can easily exceed the loudspeaker cable's low resistance and hamper your damping factor. (Mind you: there are four contact crossings in each loudspeaker channel's electrical current path). The use of good connectors and being able to firmly clamp them is important.

We strongly advise against simply connecting the bare (twisted) loudspeaker cable ends directly to your loudspeaker and amplifier's terminals. Not all the loudspeaker cable's strands will make a good contact this way. They also may fray and cause a short circuit and they even may corrode; Such connections are prone to introduce distortion.

If you don't want to use proper connectors, at least make sure that the cable ends are decently twisted and saturated with solder (preferably silver-saturated solder, see "If you mount connectors . (4)" above ); This guarantees that all strands make a good electrical contact. Furthermore the cable end is now rigid and thus can be firmly clamped.

If you prefer screw or nut type connectors, remember that there is still air in between the two contact surfaces. If you want to have absolutely the best connection, solder these metal to metal contacts to seal the joint. Solder well and use silver-saturated solder (see "If you mount connectors . (4)" above).

(Note: You may have to use a heavy soldering iron here. Before soldering remove any plastic connector parts that can otherwise melt!)

Cable length regarding change of connectors and/or frequent use:

Never make your cables too short. When e.g. after intensive use you want to change your connectors, it is easier to start with a fresh cable end by removing a short length. It is also better; as during their use cables are most often bent close to their connectors, the cable's internal strands may have been exposed to stress there. Removing some length will make more sure that you start at a point where the internal strands haven't been exposed to stress before and are less prone to break.

### **Cable life and temperature:**

For a longer lifespan, avoid running your cables near to places where high temperatures can arise, like power amplifier heatsinks or tube equipment.

### **Cable life and floor placement:**

Don't stand on or walk over your cables. Especially interconnect cables with thin internal strands can be damaged. The cable's electrical capacitance locally can change too. In digital audio interconnects this can worsen jitter performance by introducing signal reflections.

**Cable life regarding environment and handling:**

Bear in mind that the purest copper is only classified as OFC (Oxygen Free Copper) directly after it has been produced and that it won't retain the same quality after time, especially if the wires are unprotected. As a result, the initial quality of signal transfer does not stay forever, but rather is influenced by all kinds of environmental and handling factors.

At our side we have taken all possible design measures to protect our cables' conductors as good as possible. This together with your handling your cables with care will ensure their long and pleasurable performance in high quality listening.



# SILTECH

## Comparison of different materials

A large variety of suitable materials are available for cable manufacturing. The choice of silver and gold needs some explanation.

### The Conductors.

For conducting an audio signal there are a few important things to remember:

Electrons perform the transmission of electrical signals.

As these electrons have to travel through a conductor, they attempt to find the least possible resistance in their path.

Resistance itself should be linear, without irregularities whatsoever.

Also the properties of the cable should be constant and not change over time!

So now we know what to look for:

A material which employs the least possible resistance; The most suitable materials are Silver, Copper and Gold.

Silver has the lowest resistance of all, followed by copper and gold.

Gold has the best micro-level conductivity followed by silver.

Gold does not change in normal environments; its electrical properties remain unchanged. Silver may oxidise, but this does not change its electrical properties. Copper is very susceptible to oxidation and this changes its electrical properties considerably.

Copper oxide is an insulator; by contrast, Silver oxide is a very good conductor.

The linear resistance for micro signals has to do with the physical structure of the metal. This explains why silver and gold are most suitable for conducting audio signals with a large dynamic range.

To obtain the best results, the natural atomic group-structure has to be carefully maintained. Crystal formation and crystal group orientation strongly influences the total behaviour for electron movement or signal transportation.

After comparing the transmission of different metals and non-metals, silver and gold prove to be the most suitable materials for conducting audio-signals.

Silver outperforms copper in all electrical aspects as well as being more stable.

Despite the fact that many believe there are significant differences between copper and silver cable regarding sound quality, this is usually not true.

There is no typical sound performance among copper cables, nor is this the case with silver cables. If two cables are made identically, except that one uses copper and the other silver of similar quality, the overall quality and sound will be comparable. The silver version, however, should outperform the copper version in every sonic and electrical aspect.

### Cable construction.

There are many different solutions, all with plusses and minuses. Generally speaking, an ideal audio cable should have the following properties:

No (series) resistance, why?

Because any signal travelling from one crystalline unit to another should not be changed. Every bit of resistance just means that not all the signal is transported to the next unit. Also due to leaking ground currents the ground resistance of the wiring plays a major role in the degrading of the sound quality.

No capacitance, why?

Because capacitance just means an extra load for the signal entering the cable. Also dielectric effects cause storage of the signal into the insulation.

No inductance, why?

Because inductance just means a higher series impedance at higher frequencies. This causes uneven distribution of higher and lower frequencies.

Chosen constructions of Siltech cable are:

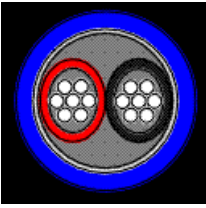

**Twisted:**

In order to reach a good balance between electrical parameters, one of the constructions is twisting.

**Advantages:**

Electrical good balance between the three main electrical parameters.  
Low microphonic feedback.

Flexible with low stress on conductors.  
Balances out low and high frequency noise from outside.  
Relative insensitive to external magnetic fields.

**Disadvantages:**

Higher production cost.  
Overall appearance is less smooth due to winding technique.

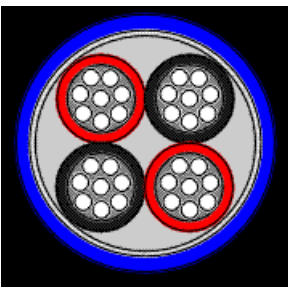

**Star-Quad:**

In order to reach a good balance between electrical parameters, one of the best constructions is the Star-Quad.

**Advantages:**

Electrical good balance between the three main electrical parameters.  
Strong mechanical construction.  
Low microphonic feedback.  
Symmetrical construction.  
Flexible with low stress on conductors.

Balances out low and high frequency noise from outside.  
Relative insensitive to external magnetic fields.

**Disadvantages:**

Higher production cost.  
Overall appearance is less smooth due to winding technique.

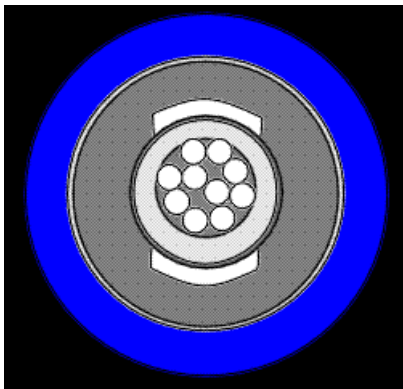

**FTM:**

For Interconnect we developed a new approach, the FTM series. This is in effect a high-tech solution which is a combination of a double helical spiral and a centre core.

**Advantages:**

The behaviour adds to the benefits of star-quad the superb high frequency performance of a coaxial transmission line cable.  
Ground inductance is lower and ensures a low impedance path between connected equipment at an extreme wide frequency range.

**Disadvantage:**

Higher production cost.

## Technical considerations on interconnects.

If capacitance is kept low, internal series resistance is of the highest priority. Resistance can be kept very low by using more conductors. The lower this value, the lower the loss in a cable.

Low resistance reduces noise induced by power transformer leakage currents. These noise levels are linear with the ground resistance of the interconnect. Common ground peak currents found in audio equipment are 20-300 mA. For an average one meter cable with a total impedance of 1  $\Omega$ , the signal-to-noise of the system will be limited to about 80 dB independent of what the system is capable of. As modern sound systems easily attain a dynamic range of over 90 dB, this reduction is very noticeable indeed. Switching to a Siltech cable will immediately bring 'silence' and restore dynamics to the reproduced sound.

Compare this 80 dB with the 121 dB figure for Siltech 'SQ-56 G3', a difference of over 40 dB or put differently one hundred times quieter! This of course is very noticeable in any quality sound system. The reference SQ-88G will better this figure by 5 dB to 126 dB. With low leakage currents like 20 mA, the clean dynamic range for a 'SQ-88GOLD G3' will be over 140 dB, better than any available system today. With 24-bit recording techniques (DGG and others just started) the increased dynamic range, characteristic of Siltech cables, is a great asset.

Another example:

In a Siltech FTM-4 cable, impedance is less than 0.0095  $\Omega$  per meter including the Siltech terminated original WBT0150 connectors. If compared to the average minimum input (= load) impedance of 10 k $\Omega$  this means a signal-loss of about 0.00001 dB, consequently the clean dynamic range at the same leakage current mentioned before is about 134 dB.

Series inductance and parallel capacitance both tend to reduce higher frequency output, producing a roll-off of the high notes. In practice the effect of capacitance depends largely on the output impedance of the driving stage.

If the output impedance remains under 100  $\Omega$ , phase shift due to capacitance in interconnects is usually small and not sonically detectable. In practice, high-frequency loss due to inductance only has effect on speaker cables. With modern amplifiers and CD players, output impedance is almost always low. Tube gear however, often displays a higher and often non-symmetrical output impedance.

Especially with long interconnect of several meters, loss of high frequencies can occur with every interconnect. In this case we recommend the use of a Siltech FTM-4 series or SQ-88 GOLD G3, which presents us with an exceptionally low loss in high frequencies.

## Technical considerations on speakercables.

How much is the speaker performance affected by the quality of the cables?

High linear conductivity is the main issue again. Siltech cables present very low resistance, and thus lower loss of the signal. This improves the control over the speaker, its dynamic behaviour and soundstage, focus and dimensionality. Bass performance is improved in clarity and articulation.

Example 1:

Amplifier: ML331, Speakers: Thiel 3.6, 2 meter LS-38 G3 versus LS-100 G3.

The low-frequency loss and damping-factor:

LS-38 G3: Loss 0.35dB DF=55

LS-100 G3: Loss 0.05dB DF=88

The net effect?

Better bass, more body and weight, closer to real life performance.

Example 2:

Amplifier JADIS Defi 7, Speakers Sonus Faber Guarneri, 2 meter cable.

LS-38 G3: change in theoretical maximum DampeningFactor: -5 %

LS-100 G3: change in theoretical maximum DampeningFactor: -1.5 %

LS-180 G3: change in theoretical maximum DampeningFactor: -1 %

The net effect?

Again tighter bass, more control, better focus, closer to real life performance.

The loudspeaker performs closer to its original design goals.

How much do tube power amplifiers benefit from Siltech's low-loss principle?

A lot. The use of output transformers and the low overall feedback in most tube-designs cause higher output impedance compared to transistor designs. Therefore, a loss of control over the speaker behaviour is the net result with most common speaker cables. By using a Siltech speaker cable, losses are minimised and the control over the speaker will improve, which results in a much better over-all performance of the tube power-amp.

# Monster Cable

## Glossary:

### Amplitude Balanced Multiple Gauged Conductors

Selected based on the depth of penetration of audio frequencies into the conductor material (in Monster's case this is high purity OFC copper), different sized conductors are optimized for certain frequencies, and the calculated combinations help determine the frequency balance, the sonic energy capabilities at those frequencies (ability to drive current in the case of speaker cables), and phase characteristics of the cable. 

The parameters for this type of design vary with interconnect cables vs. speaker cables. In interconnect cables we want to accurately pass voltage, and in speaker cables we want to pass current. In interconnect cables we are driving high impedances, while in speaker cables we are driving complex low impedances, creating severe limitations in a speaker cable's ability to drive current at low frequencies. Since typical interconnect cables are low inductance and higher in capacitance, current leads the voltage by 90°, causing time domain distortions. In speaker cables, the opposite is true: inductance is higher than the capacitance and speakers require current, not voltage, to drive the bass energy, especially where the impedance of some speakers is very low at bass frequencies, causing a loss of control and more time domain and amplitude distortions.

A good example of the validity of this approach is the popularity of solid core cables and the concept of bi-wiring: cables that are biased towards certain frequency ranges. However, a non-scientific, haphazard approach to Amplitude Balancing will produce mixed and unpredictable results, and focus typically on a limited frequency range. Monster's Amplitude Balanced constructions are calculated and modeled by computer, and then verified by careful listening tests. 

Amplitude Balanced construction is used in Monster's highly acclaimed New Monster Cable (frequently referred to as Monster BiWire), which features separately insulated networks for the high and low frequencies. Monster's Custom Installation Series actually incorporates a solid core along with multi-strands, and the new M Series cables use multiple solid core construction along with time compensated conductors.

### Bandwidth Balanced Design

This technology combines Time Correct windings with the use of selected multiple-gauged constructions to pass the music in correct amplitude and phase. Monster's balanced design interconnect cables use equal conductors for the positive and negative conductors with a passive "ground" shield. The positive signal must be identical to the negative signal, electrically and magnetically, otherwise there will be an imbalance, causing a resultant signal that is a distortion of the original waveform. That is why coaxial cables, commonly used in low cost interconnects (and some high priced ones also), cannot be correctly time compensated and will always be inaccurate.

The results of distortions in wire are audible because in the analog world, we directly hear the electrical signals transferred to vibrations in the air. These vibrations reach our ear drums, which send the signals to our brain, where we interpret them as music. Any distortions in this chain are correctly and accurately detected in our ability to hear variations in frequency and time, which relates to our perceptions of music, harmonic overtones, directionality, dimensionality and space. Monster's Bandwidth Balanced constructions overcome most of these distortions (no wire is perfect) in a way that no other cable can. It's obvious that regardless of the purity of the material used (we have evaluated all the various LCOFC, OCC, six 9's copper, etc.), one must still overcome amplitude and time domain distortions to achieve accurate sound reproduction.

One can hear the frequency extensions, phase characteristics and dimensionality of Monster's three-network Interlink Reference and M1000 Mk III vs. our less expensive two-network Interlink 400, or our network-less Interlink 300, or some other manufacturer's coaxial or balanced cable that has no amplitude or phase compensation at all. Be aware that the use of multiple gauged conductors themselves is no guarantee of sonic accuracy, and that correct winding constructions and accurate manufacturing are significant factors.

## **Bass Control Conductors**

This technology is incorporated into our Powerline 2 Plus and Powerline 3 Plus cables, and will continue to be used in future designs. Monster's Bass Control Conductors incorporate the design of a carefully sized bass conductor that is calculated in consideration of the other gauges that are used to give proper reinforcement of certain low frequencies. This conductor is typically positioned in the center of the conductor bundles and wrapped in a large dielectric to allow the break-up of internal magnetic fields. The combination of the correct sized cable bundles with the winding of the outside conductors gives us a highly refined, "balanced" sound that is smooth and controlled with a high degree of depth and image.

## **Linear Polyethylene Dielectric**

As discussed earlier, the dielectric is extremely important to the sound of a finished product. Linear Polyethylene Dielectric, or LPE, is used where that interface is critical: between the copper conductors and clear PVC (as in the case of XP). Monster's more expensive cables utilize even better dielectrics, but do not maintain the ability to be transparent, which explains the higher performance of Powerline 2 Plus, Powerline 3 Plus and the M Series.

## **Magnetic Flux Tube**

This is the technology of running a dielectric down the middle of a connector bundle or a large insulated wire. The dielectric "breaks up" internal magnetic fields that are strongest at the center, thereby reducing the time related distortions of conventional cable. This design is even incorporated in our lowest priced XP speaker cable, which, when compared to other cables of the equivalent gauge and "look", far outperforms them in the areas of neutrality, smoothness and lack of high-end grittiness. Dynamic range is also more noticeable since the apparent noise level is reduced. We invite you to listen to Monster's speaker cables that employ this unique design technology.

## **MicroFiber Dielectric**

Since much of an audio signal passes through the magnetic field surrounding the conductor, the quality of dielectric plays an extremely important part in cable construction.

The dielectric affects a cable in two ways. One is the quality of insulation between the positive and negative conductor, and the other is the isolation of the groupings of multiple strands (and in our case multiple gauges) of wire in the same conductor. MicroFiber, which is Monster's patented design of wrapping a wire strand (or group of wire strands) with a dielectric comprised of 30% air (the best dielectric of all except for a vacuum), has superior characteristics in the area of low energy storage and energy loss. Energy in this case meaning all the components of an audio signal in terms of its electrical, magnetic, electrostatic and current transfer components.

MicroFiber is used in Monster's cables to isolate individual networks in the same conductor. The result is a music signal that is very fast in its transient and dynamics, which is important in today's music.

Listen to the difference between Interlink Reference 2 (with MicroFiber on the bass and mid bass networks, but not the high frequency networks) vs. the M1000 Mk III, which has MicroFiber on all three cable networks. The rest of the construction is virtually identical. The M1000 has all the detail and depth of the Interlink Reference 2, but with better control over the top end and less high frequency smear. Of course the cost of the M1000 is higher. Also audible is the difference between Monster's older Interlink 4 vs. Interlink 400. The only difference between the two is that Interlink 4 uses a varnish dielectric (as used in Litz wire) and the Interlink 400 uses MicroFiber.

A further test of MicroFiber is to listen to the increase in clarity and detail, as well as extended frequency response (because of the isolation between multiple-gauged conductors), between Interlink 400 and Interlink 401 (again, the only difference in the conductors is that Interlink 401 does not have Microfiber).

## **MultiTwist**

MultiTwist is an advanced cable construction that brings out nuances by minimizing intertransient noise and improving dynamic range.

## Time Correct Windings

While effective in lower cost cables, Amplitude Balanced construction does not complete the whole picture. Time domain distortions can be improved, but cannot be accurately controlled to give us the sonic attributes that are related to phase as described earlier. **In interconnect cables we correct these time domain distortions by creating a longer path and higher impedances for the higher frequencies. We cannot speed up the lows, so we must delay the highs. By winding the high frequency conductors to create inductance at those frequencies, we delay them in time to pass through the cable at the same time with the slower lower frequencies.** This develops the ability to capture lost phase-related information such as dimensionality, soundstage, imaging and depth. 

This technology places great demands on our manufacturing processes to precisely wind the wire, control the number of turns for the different conductors-which is especially difficult because the smaller high frequency wires need to be more precisely and tightly wound than the low frequencies, and to delicately handle varying gauges of conductors that are wound together without breakage or waste.

The complexity of the windings increases the cost proportionately since machine time is very expensive. The complexity of Monster's constructions in our higher priced cables is apparent to the eye, but it's the audible results of Time Correct construction that are well worth the cost and effort.

## Turbine Design RCA

This is truly the highest quality RCA connector ever made. If you think about it, the connector is also a cable, and whatever attributes are important to cable design, also apply to connector design - and more.

That's why Monster's Turbine is made from a single slug of material that is machined out to maintain its mass (other connectors are simply folded over sheet metal), and then each cut is made on an indexing cutter to maintain a precision fit and maximize the mass of each "finger." There are four features important to the audibility of connectors:

- Contact Mass
- Contact Points
- Contact Area
- Contact Pressure

The Turbine excels in all of these parameters, especially contact pressure, which is important with heavy cables. This means that bass, dynamic range, smoothness and coherency are audible in an excellent connector design. Car stereo applications are also extremely important when it comes to contact pressure, since nearly all car stereo installation call-backs have to do with wiring-grounding, intermittent channels, noise, distortion. Remember, even though it sounds good today, will it sound good tomorrow?

## FAQ

### Question: What is Time Correct technology?

Answer: Monster's way of compensating for something called "Velocity Propagation" or better known as the skin effect. **An analog audio signal passing through a copper cable succumbs to this law of physics in which bass frequencies tend to gravitate towards the center of the cable; higher frequencies are forced to the outer portion of the cable. The higher mass bass frequencies create a magnetic field in the center of the cable while traveling through the conductor, which impedes those lower frequencies. This impedance forces those lower frequencies to arrive at their destiny (the speaker or amp) delayed, which causes a mild distortion in the waveform. Monster utilizes multiple gauge windings to help compensate for this distortion. Large, solid-core copper strands in the center for bass frequencies (containing higher mass) and smaller gauges wrapped around the solid core conductor to delay the mid's and high's ensuring that the entire bandwidth of frequencies arrive in uniform.** 

### Question: What is magnetic flux tube?

Answer: This is a specially-designed dielectric tube that runs down the middle of a group of different gauge windings. This helps break up the magnetic field generated from the current flowing through the cable's conductors. We wrap the larger solid-core conductors (the culprit of this magnetic field) around this dielectric for maximum affect.

# Straightwire

## WHAT BETTER CABLES CAN DO FOR YOUR SYSTEM

### CABLE ANALOGIES

#### ALL CABLES ARE FILTERS

All audio cables act as complex passive filters with elements of capacitance, inductance & resistance. While they have observed sonic & electrical tendencies - cables are reactive (and can have a complimentary, neutral or derogatory effect in systems).

#### TECHNOLOGY ADVANCEMENTS NECESSITATE BETTER CABLE

Major advancements over the past decade in audio/video equipment include digital processing, polymer speaker cabinets and better surface mount circuit design. Because of these advancements, you can hear the difference of high performance cables more than ever before in your system. Like tires for your car . . . you consider tuned suspensions, reduced road resonance, wet pavement abilities, . . .

#### BETTER CABLES ARE LIKE CLEANING YOUR WINDOWS

Inserting low quality cables will mask and veil sonic & visual details. Better cables are like cleaning a window or your glasses - you realize afterwards that images are clearer and sounds more precise.

#### WHAT YOU'LL GAIN FROM HIGHER LEVEL CABLES

Generally speaking, moving up in the cable level provides more conductor groups for lower electromagnetic effects, increased quality of insulation for less capacitive storage and increased conductor quality (for increased and more uniform velocity of propagation). You can hear & see the improvement with better Straight Wire.

Cable is a component (not accessory)  
because your system won't function without it.

## CABLE FABLES

### FACTUAL ANSWERS TO COMMON CABLE MISCONCEPTIONS

#### THICKER IS ALWAYS BETTER

Basic speaker wire with two parallel conductors act as opposing magnets which rolls off (cancels) part of the music signal. As the conductors get big (12Ga +), electromagnetic fields distort the closest portion of the opposing conductor (PROXIMITY EFFECT)

Better to divide the conductors into smaller, alternating (pos,neg,pos,neg .) groups

#### LONG CABLE DOESN'T EFFECT PERFORMANCE

A short cable will have not just lower resistance but less reactance (inductive & capacitive) than longer cables of the same construction. Keep them short and at a standard length. Get cable long enough to access components & meet future placement needs.

#### SILVER IS BETTER THAN COPPER

While silver offers greater theoretical conductivity than copper by about 1%, it has a different sonic signature (clearer & faster for highs - not as full for bass). Silver oxidizes differently and is usually cost prohibitive. Some cables use silver plating effectively.

## **GOLD PLATING INDICATES A CONNECTOR IS GOOD**

Gold plating is usually a very thin layer (usually over a bright nickel base) which will resist corrosion. It looks good but is frequently applied over low quality base metals. Other materials such as silver, rhodium & platinum have benefits which may not be cost or application justified for audio / video systems.

## **MUST HAVE SAME LENGTH CABLES**

The difference is not the time it takes the signal to go through the cable, but the complex reactance (filtering) that will take place largely due to resistance. Cable lengths within 25% of each other for moderate to intermediate systems are not optimal but OK. Sales people should caution customers to buy standard matching length pairs of cable in case they change rooms, move equipment or think they might trade-in or resell the cable.

## **INTERCONNECTS DON'T NEED TO BE SHIELDED**

You cannot always predict the RF and other forms of interference (EMI) found in many homes. Many high end interconnect cables without proper shielding or shield termination are hindering system performance. Most background noise and grounding problems can be eliminated with well shielded signal & video cables. Not so critical for most speaker cables unless you are running them directly on AC power lines.

## **BARE SPEAKER WIRE IS BETTER THAN GOLD PINS or FANCY ENDS**

Bare copper, regardless of purity will oxidize & corrode, especially with current running through it. It is better to attach a gold plated end which will resist corrosion or cover the end with silver solder.

## **HIGH CAPACITANCE IS ALWAYS BAD**

Don't let consumers intimidate you because their engineer friend told them to get the cable with the lowest capacitance per foot (meter). It is irrelevant in most cases - only loop capacitance (total of length x cap. per foot) is of concern for passive preamps and sensitive (usually unstable) components. Some cables have relatively high capacitance (120 pf/ft+) but ultra-low inductance which usually works great on tube electronics.

## **BI-WIRING ALWAYS MAKES A BIG DIFFERENCE**

Many speakers today have double sets of binding posts which allow for bi-amping or bi-wiring. The audible benefits of Bi-amping - Vertical (one amp for right speaker, other for left) or Horizontal (one amp for LF, another for mids & highs) are usually clear. Bi-wiring is especially useful when the characteristic impedance varies between the high & low frequency segments of the speaker (i.e. 3  $\Omega$  & 8  $\Omega$ ). It helps reduce the effects of backflow EMF which can smear HF details. If the characteristic impedance is close - the benefits of bi-wiring might not be as clearly audible. It is better in most systems to connect with a single run of a high quality cable than to Bi-wire with two lower quality cables.

## **DIRECTIONALITY IS NOT IMPORTANT**

Based upon the design & shield termination of the cable - directionality can matter. Most cable manufacturers put directionality arrows on cables based upon research & listening evaluations. Some models of cable are symmetrical and directionality is not critical. You should know if the shield is connected at one end of the cable with the negative conductors or if it is "floating".

## **BREAKING IN CABLES MAKES LITTLE DIFFERENCE**

Just as amplifiers and speakers will sound better after 30-50 hours of use, cables may have a one-time capacitive effect when the insulation is first exposed to current. This is especially true of cable with "Litz" conductors or individually coated strands. The insulation will stabilize electrically - midrange will have greater depth & warmth. The cable will sound smoother - less analytical in many cases.



## **SONICS & EXPLANATIONS OF STRAIGHT WIRE CABLES**

### **MATERIALS**

(EACH INGREDIENT HAS ITS OWN SONIC FLAVOR AND TENDENCY)

### **CONDUCTORS**

COPPER - good bass, solid midrange, potential variance in HF based upon strand diameter

BETTER COPPER- better bass, clear midrange, HF less restricted if strands have less surface corrosion

COATED COPPER - minimizes strand - strand (electrostatic) effects

HF clear if coating not too thick or poor dielectric

SILVER PLATED COPPER - minimizes copper oxidation & adds slight HF speed if coating is thick (2%+)

COATED SILVER/COPPER - with thick silver (10%+) very stable with excellent sonic tendencies.

SOLID SILVER - high velocity of propagation- HF can be too dominant bass is tight, clean and can be lean.

### **INSULATIONS**

POLYETHYLENE - common insulator with fair mids and highs foamed versions are more accurate, bass is OK.

POLYPROPYLENE - tight bass, accurate midrange and sharp highs can perform better (less absorption) if foamed.

HARD TEFLONS - strong bass, relaxed mids, HF not restricted

FEP and skived types may pick up mechanical noise.

FOAM HYBRID TPR - full bass, lush mids, clean HF excellent mid bass- non resonant, spongy.

SOFT FOAM TEFLONS - accurate bass, lifelike mids and highs great insulation - must be careful in manufacturing not to crush or performance will vary.

### **DESIGNS**

**(THESE RECIPES HAVE BEEN REFINED AND PERFECTED OVER THE PAST 15 YEARS)**

SYMMETRICAL COAX - very accurate, low inductance design provides very uniform electromagnetic control. Tight not sloppy, detailed not bright. We have been one of the few companies perfecting this design for over 15 years!

USED FOR SPEAKER CABLE , INTERCONNECT & DIGITAL

STAR QUAD - low noise, smooth highs, distinct vocals, full and controlled bass can be configured in balanced, unbalanced and noise dumping terminations. We optimize for balanced resistance and controlled impedance.

INTERCONNECT

HELICAL ARRAY - similar design used by many companies - we optimize it. Choose strand size for best current penetration and accurate twist (little air space). Insulation and thickness is based on simultaneously optimizing 4 parameters. Non conductive cores allow for good mechanical stability and control of music.

SPEAKER CABLE, INTERCONNECT

DUAL SYMMETRICAL COAX - Utilizes twin coaxes for great shielding and versatility in termination options. Delivers music signals with all nuances intact - even over long runs. Enchanting presentation with true tonality and depth. One piece of cable with this design can carry two channels ( not suggested for premium performance but a consideration when space is limited).

USED FOR SPEAKER CABLE , INTERCONNECT

### **PROCESSES**

**WE TAKE A HANDS-ON APPROACH IN 'COOKING' OUR CABLES TO ENSURE PERFORMANCE THAT APPEALS TO ALL PALLETES.**

CONDUCTOR BRAIDING - special machines at slow speeds for low deviation

EXTRUSIONS - temperature, moisture and cooling are highly controlled

TAPE WRAPPING - critically monitored by technicians & tension analyzers

LESS REWINDING THAN OTHER CABLE MAKERS - unique machines we have built to reduce handling which tends to deform or alter structure.

## MECHANICAL ISSUES

We perform serious research & development

DIELECTRIC & JACKET COMPLIANCE - careful analysis & control

FILLER MATERIALS - various ones for low dielectric & specific needs

CONDUCTOR DIAMETER / RESONANCE TENDENCY

NATURAL CABLE RADIUS / STRESS - wall thickness, fiber braid layers and real life application factors are carefully considered.

### Level 1 Speaker Cables:

Abundant OFC & OFHC Conductors for low resistance.

Advanced insulations for extended frequency range.

Twisted (non-parallel) conductors for less noise.

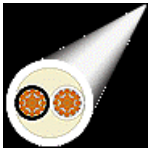

**Duo**, unlike conventional (twin lead) speaker cables, accurately delivers the full power and frequency range of your receiver. Its larger, Oxygen Free Copper conductors are twisted to retard signal loss. Various colors to suit your decor.



**Rhythm** helps your speakers reproduce the delicate high frequency range with improved OFHC (Oxygen Free High Conductivity) conductors and polypropylene insulation in a quad twist. Tight focus & detailed presentation. IBW (internally bi-wireable cable)



**Quartet's** large four conductor design is a must for basic bi-wireable speakers. Its hybrid-foam TPR insulation maintains a warmer sound with full extended bass that contributes to the overall enjoyment of your system. IBW (internally bi-wireable cable)

### Level 2 Speaker Cables feature:

Foam hybrid TPR insulation for full non resonant control.

Coated and bare OFHC conductor in bi-wireable groupings.

Helical arrays with non-conductive cores.

Flexible non-marring jackets of soft durable polymer.

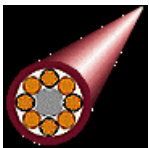

**Stage eclipses** competing cables in this class with an eight conductor helix design that excels in midrange precision and focused highs; both positioned in a 3-D soundstage. IBW (internally bi-wireable cable)



**Sextet**, like all Level 2 cables, offers the option of internal bi-wiring for many of today's better speakers. Full, developed bass with rich midrange make Sextet a great cable for a variety of speaker applications. IBW (internally bi-wireable cable)



**Octave** features eight coated CCT copper conductor groupings for a significant advance in detail and precision. Far greater control of all cable properties is achieved through a costly process of coating each individual copper strand. The benefit is a level of sound quality and long term conductor purity that is otherwise impossible to achieve. IBW (internally bi-wireable cable)

### Level 3 Speaker Cables feature:



**Encore II** elevates the performance of any speaker to a higher level with its Sintered Foam Teflon and coated OFHC copper. Both positive and negative signals are resistance balanced, resulting in even propagation at all frequencies. Its musical presentation is resultingly deeper, with more defined placement.



**Rhapsody II's** Symmetrical Coaxial design uses the same premium materials found in the Rhapsody II interconnect. Ideal for listeners who prefer smooth, extended highs with a warm, but never loose, bass foundation. Rendering of spatial details is accomplished with convincing weight and outstanding dynamic contrast. Rhapsody II is universally compatible with nearly all speakers. Great choice for external bi-wiring.



**Maestro II**, with Supermicroporus Foam Teflon insulation in a Symmetrical Coaxial design, paints one of the most expansive, precisely defined soundstages available. Ideal for ultra pure systems which require critical resolution, Maestro II leaves no detail to chance. A recommended classic.

### Level 4 Speaker Cables feature:

**Serenade** speaker cable: Advanced Helical design featuring "CCT" (compressed copper technology) conductors and super foamed polypropylene insulation. Serenade delivers an engaging, full soundstage for true "lifelike" performance. You hear all of the details and inflections of the performance totally unrestricted by this low resistance speaker cable. There is no cable in the industry that can touch Serenade's performance attributes at its price. IBW (internally bi-wireable cable).

**Virtuoso R** speaker cable stays true to the lifelike musical presentation of its interconnect sibling while managing the more difficult task of simultaneously passing both current and signal. This is accomplished effortlessly and gracefully by this super premium design, which has been calibrated to match the widest array of reference speakers. Instruments and voices are precisely placed in your room with a level of realism that will make you shiver during dynamic passages.

**Crescendo** Technological breakthrough in speaker cable design and performance. Crescendo features ultra pure, certified, compressed copper conductors in an advanced helix design. Compressed copper technology (CCT) delivers all of the best characteristics of solid core and stranded wire conductors. This means that Crescendo is the most transparent cable on the market while transferring all of the sonic information from your source. A truly holographic soundstage that puts you into the performance, an experience previously only dreamt about. Crescendo is the new standard in reference level cables and will be for years to come. IBW (internally bi-wireable cable)

## SPECIALTY CABLES

**Silver Surfer** is a large format, internally bi-wireable speaker cable. With hybrid silver / OFHC conductors in a Helix design, the quality of material and construction are completely unexpected in this price range. Offering one of the most engaging robust performances available, Silver Surfer renders detail with a sense of space and smooth articulation that will allow most any system to perform on an advanced level. IBW (internally bi-wireable cable)

**Pro Special** speaker cable has the smallest diameter relative to its audiophile, high performance design. Without the advanced fabric braid jacket and coated conductors, Pro Special features the same geometry and overall design of Encore II speaker cable. The result is a performance cable that excels in detail and solid bass foundation - all in a compact, affordable package.

**Backstage** is the industry's first speaker cable optimized for use in rear channel applications. With special twisted OFC conductors in a low loss dielectric design, it excels in runs over 20 feet. Backstage will allow rear and surround speakers to coherently reproduce all the information available with spacious and powerful dynamics.

**Black Silc** utilizes certified coated silver/copper in a helical grouping of 12 conductors. Internally bi-wireable, Black Silc's unforgiving nature mates best with components that can withstand scrutiny. Speakers with true extension below 40Hz will reveal Black Silc's strength and delivery in the lower bass registers. Vocal and higher registers are conveyed in an amazing combination of speed, focus & resolution. IBW (internally bi-wireable cable)

**B-Flat** speaker cable: designed for maximum flexibility with a low profile. B-Flat solves those problem wiring areas as the perfect cable to run across floors, under carpet, around doors and along baseboards and ceilings. With a durable jacket which is easy to paint or glue, B-Flat can become almost invisible in your installation. 14 gauge OFC copper braided conductors provide outstanding performance from this economical flat speaker cable. The off white jacket does not absorb dirt and stains like other competing flat cable made with interior insulation.

# NBS

## **What does NBS stand for?**

NBS stands for Nothing But Signal. This is the key to the design philosophy behind our cables. At NBS, we do not attempt to "reproduce" sound. Instead, we RETRIEVE what's on the recording.

Most audio cables incorporate devices of one type or another to filter-out undesirable frequencies. While these devices do remove a certain amount of hiss, they also, by their very nature, add to the noise floor. NBS cable does NOT employ any ancillary device. We use a unique weave of solid core copper combined with unconventional applications of silver shielding to achieve true retrieval of the recorded sound.

As a result, NBS cables deliver the lowest noise floor in the industry - reducing Radio Frequency and Electromagnetic Interferences up to 98% - while transmitting the FULL dynamic range of recorded sound. That's why, with NBS cables, you literally hear nothing but signal. This is the primary reason why NBS cables convey such a realistic presence.

You can test this with your own ears by listening to the pauses in recordings. No one delivers silence like NBS. You'll also experience an increased gain (volume boost) as well as significantly greater clarity and recognition with NBS cables.

## **What's in these cables that they're so darn expensive?**

While the materials we use in NBS cables are undeniably the best money can buy, it's what's NOT in them — as well as what IS — that makes them costly.

Many cable manufacturers use a "cheap fix" to attain a reasonably good sound. Some simply modify mass-made spooled cable with their own connectors. Others incorporate resistors, capacitors, or coils to alter the frequencies the cable delivers. Most rely entirely Teflon or other synthetic materials for a dielectric.

While these approaches work to a certain degree, each possesses it's own set of limitations. NBS cables do NOT rely on pre-manufactured designs nor on additives or synthetics to achieve pure sound. The secret is in the design itself—a Passive Frequency Inductive Network—which can only be achieved at the NBS level of efficiency through hand-made construction, using the purest available copper, gold, rhodium, chromium, and silver.

Every NBS cable is individually crafted — NOT machine manufactured — and is then hand-tested. All NBS cables are guaranteed for life to the original owner.

## **How do I get the most out of an NBS Black Box?**

Ideally, every component in your system should be outfitted with an NBS A/C power cable. In the real world, however, the necessary number of power outlets are not always available. And in some cases, the A/C cords may be hard-wired in a component, prohibiting the use of a detached cable.

NBS Black Boxes were designed to accommodate these realities. Our Black Boxes are intended for front-end components such as turntables, CD transports, digital lenses and the like. We do NOT recommend using an NBS Black Box for amps and preamps.

Amplifiers should be plugged directly into the wall using NBS A/C power cables. This configuration of Black Box use for front-end components and individual NBS A/C cables for amplifiers fully utilizes the capabilities of our designs.

# Mogami

## A myth about electric currents - What exactly happens when sending electric currents into a wire?

Everyone knows that a magnetic field is created inside and around a conductor when sending electric current into a wire conductor. Experiments we conduct with electromagnets in Japanese elementary schools are based on this understanding, and there are many products which apply the principle of electromagnets. Since various devices using this phenomenon work as they should, we are under the impression that the principle is no doubt questionable.

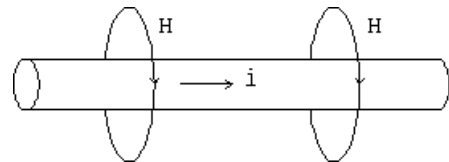

Electric currents create an electromagnetic field

By observing the movement of the needle of a compass near a wire while connecting a wire to a battery and a light ball, the above statement can be easily confirmed. Although the concept of fields, such as magnetic, electric or electromagnetic, is not an easy process to comprehend, let's simplify for now that fields represent some quality of space created by electric charge or magnets.

Most people know for the fact that a magnet field is created by passing electric currents through a wire. But do they really understand? There is a huge gap between the knowledge and the understanding. Let's look closely at this question, using a simple example.

First of all, sending currents in a wire means there are the movement of electrons in the wire. It's been decided by an unfortunate historical event that currents run toward the direction that is the opposite of electrons. This fact itself is not a serious problem. Since electrons' movement explanation leads us to a complicated phase in the quantum theory, we will not discuss further this issue.

The movement of electrons is relative to how we look. If we stop and look at electrons in a wire, we see the electrons moving. But if we move at the same speed as the moving electrons, they should look static. Since their movement is not so fast, it's not an impossible task.

### Pulse response of cables

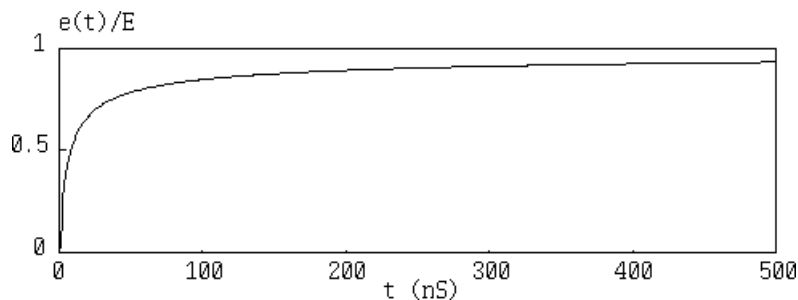

Here is a wave form of step pulse response when a 100 meter long coaxial cable (JIS C3501, 50  $\Omega$ , 3.0 mm insulation diameter) is used. The wave form that rises up steeply first and then rises moderately is often seen as an exponential wave form of C-R charging circuits.

However, since in transmission theory of electrical engineering, a condition that a secondary parameter under high frequency of cables is  $R \ll \omega * L$ ,  $G \ll \omega * C$  holds good, the following approximation is very accurate (1).

$$a = R / Z_0 / 2 + G * Z_0 / 2$$

$$b = \sqrt{L * C}$$

where

a = Attenuation constant (neper/m)

b = Phase constant (rad/m)

L = Inductance (H/m)

C = Capacitance (F/m)

R = Resistance ( $\Omega$ /m)

G = Conductance (G/m)

$Z_0$  = Characteristic impedance ( $\Omega$ /m)

On the other hand, R has a big frequency dependency, and under high frequency it increases in proportion to a square root of frequency. However, as long as high quality dielectric material is used, C, L, and G don't have frequency dependency. It means there is no phase distortion in high frequency cables and only attenuation distortion exists. This fact can be confirmed by simple measurement with network analyzer or similar equipments. Therefore transmission theory doesn't have any fundamental error.

However if this is true, since attenuation distortion simply makes wave form dull as you can see from linear circuit theory, the first part and the last part of wave form should be symmetrical. It is impossible that the first part is steep and the last is moderate. It should be like the one shown below.

Now you see there is a contradiction between transmission theory and circuit theory, which are supposed to be true in electric engineering. What is going on here? This is the question of the puzzle.

A long time ago I've asked this question to several people but never got a clear answer. People who gave me some kind of answer told me "It is an exponential wave form of C by R of a cable." But please think about it. It is a key of transmission theory that it is unreasonable to think about primary constants such as R, L, C, and G in high frequency cables, so think with secondary constants based on undulation. This denies trustworthy transmission theory. If so, where is a truth?

Note 1) High frequency approximation of attenuation constant and phase constant This is a simple calculation that approximates an exact expression,

$$a + j * b = \sqrt{((R + j * \omega * L) * (G + j * \omega * C))}$$

where

$j = \sqrt{-1}$

$\omega$  = Angle frequency (rad/m)

with an condition of  $R \ll \omega * L$ ,  $G \ll \omega * C$ .

### Puzzle of disappearing energy

Think about space that only has power source E1, switch S1 and S2, and two cables C1 and C2 that have same capacitance C.

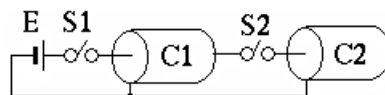

1) When you close only S1 and charge power source up to voltage E, electric charge that is stored in cable C1 is  $Q = C * E$ .

2) Open switch S1.

3) When you close switch S2, half of the electric charge of cable C1 is going to move to cable C2 and the voltage of C1 and C2 is going to be equal.

Now let's think about the energy that is stored in the cables in the circumstances 2) and 4).

First of all, in the circumstance 2) the energy W1 that is stored in cable C1 is

$$W1 = (1/2)*C*E*E = (1/2)*Q*Q/C$$

And next, in the circumstance 4) the total amount of energy W2 that is stored in cable C1 and C2 is

$$W2 = 2*((1/2)*(Q/2)*(Q/2)/C) = (1/4)*Q*Q/C = W1/2$$

Surprisingly as soon as switch S2 is closed, the total sum of the energy in this space becomes half! An opposite example of energy conservative law, which is a fundamental theory of physics, can be created easily by a simple tool like this after all. 1 meter of cable is enough to receive Nobel Prize.

### The Mystery of Inductance of Lead Wire

We sometimes see "inductance of lead wire" in Electrical Engineering technical books. For example, the following expression is found in a book titled "Analytical Noise Mechanism" by CQ Publishing Co. at its 120th page.

$$L = 2*I*(\log(4*I/d)-3/4) \text{ (nH/m)} \quad (1)$$

where

- L = inductance of lead wire (nH/m)
- d = diameter of lead wire (cm)
- l = length of lead wire (cm)

Before adapting the formula for circuit calculation, please see it carefully. There is something very inexplicable with it. First of all, it says that, because inductance of lead wire per unit length is L/l:

(1) its inductance per unit length gets infinitely bigger as lead wire gets longer and longer.

This does not make sense from the standpoint of physical science. It also says,

(2) when the length of lead is a half of its radius, the inductance becomes zero!

That sounds more strange, because, if that's the case, it will be possible to do wiring without inductance by connecting a small piece of cable of 1/2 the radius length in series. In addition, it says,

(3) When the length of lead is less than the half of its radius, inductance becomes negative figures. As the length of lead gets to zero closer and closer, the inductance approaches to negative infinite!!

If so, it enables to make a circuit of negative inductance. But, inductance is inertia against current and is circuit element which functions to prevent current alteration. Therefore, inductance in negative figures would help current alteration, which would enable the current to increase dramatically only by adding a little amount of current. That would lead to an amazing theory that a small piece of copper wire picked up from a garbage dump would solve the problem of the global energy crises. This, of course, is against one of the basic rules of physical science, the rule of Energy Preservation, and impossible to happen.

There is no explanation in the book about the basis of this formula, though I assume it is referred to the calculation by "Geometric Mean Distance"(G.M.D.) basing upon the Neumann's formula. For example, see in the 392th page of the classical famous book "Electromagnetics Phenomenon Theory" (Maruzen Publishing) by Setsuzo Takeuchi, where you will find the following formula:

$$L = (\mu_0*I)/(2*PI)*(\log(2*I/a)-3/4) \text{ (H/m)} \quad (2)$$

where

- L = inductance of columnar conductor (H/m)
- a = radius of column (m)
- l = length of column (m)
- $\mu_0$  = permeability (H/m)
- PI = 3.14159265358979



Since lead is a columnar conductor, the formulae (1) and (2) completely correspond each other in consideration of  $\mu_0$  being vacuous permeability ( $4 \cdot \pi \cdot 10^{-7}$  H/m). In other words, the inductance of lead looks as if it has affirmative theoretical background, while believing in it may mean denial of the base of modern physical science. How can we understand this "inductance of lead?"

### Mystery of electric current - Speed of electricity

It is said that electric current, which flows in a conductor, conducts electricity. Also in an electric wire free electron flowing in a conductor creates electric current.

As for free electrons inside a conductor, the most common material for a conductor of electric wires is copper and the electron density in  $1 \text{ m}^3$  is  $8.5 \cdot 10^{28}$ . For example in copper wire, of which length is 1m and the outside diameter is 0.5 mm, there are  $1.7 \cdot 10^{22}$  free electrons, which is enormous. Since copper is one monovalence metal, the number of free electrons and copper ions (atom) are the same.

By the way, free electrons in a copper wire move to random directions with the speed of  $1.3 \cdot 10^6$  m/s even in the case of no electric current, which means it is not in electric field. This velocity is called "Fermi velocity" and it exists even under 0 absolute temperature. It is not heat energy and originated from indefinite theory of quantum mechanics. Since electric current is average flow of free electrons, in other word "drift velocity", electric current doesn't exist under this circumstance.

When voltage is put on both sides of a conductor, free electrons increase the speed in proportion to the electric field and by lattice oscillation, lattice defect, and collision with impurities, they will be scattered to different directions from the electric field and lose the speed to the direction of the electric field. Therefore it doesn't increase the speed infinitely and it will keep certain average velocity. That means collision functions as a kind of friction.

As for copper, the time interval between collisions is  $5.26 \cdot 10^{-45}$  seconds and average drift velocity is,  $4.62 \cdot 10^{-3}$  (m/s) / (v/m).

It means that when 1 V voltage is put on both ends of 1 m long copper wire, the velocity of free electrons to length direction is 4.62 mm/s. It seems amazingly slow but since electric charge of electrons is  $-1.6 \cdot 10^{-19}$  C, 12.6 A electric current flows in the 0.5 mm copper wire with this speed. You see how large the number of free electrons is.

Now let's think. For example, let's say you put 50mV differential voltage, which is almost a standard limit, on 100 m of "10Base-T" cable, which is commonly used for LAN wiring. The electric field that is put on a conductor is 0.25 mV/m. Average moving velocity of free electrons is only 1.15 m per second, which is 4.1 km per hour, and it's about the same as walking speed of human.

If electric current carries electricity and electric current is electron flow, moving velocity of electricity is about the same as walking speed of human. That means that human is able to pass electric current that is conducted on "LAN" wiring so easily and we have to think that electricity is slow.

But on the other hand, we know that telephone and LAN wiring send information far faster than airplanes and when we turn on a switch of a lamp, we see it lights up instantly even if it's in the distance. How can this slow electricity do it? What is speed of electricity? Is it true that electric current conducts electricity?

### The Mystery of Transient Phenomena - Energy Generated from Naught

In the 396th page of a book titled "Electric Theory Exercise III" that has been published many years ago by ohm-sha, there is an exercise as follows. Please understand that differential signs are not easy to read here, since I have written the exercise with JIS Kanji Code that does not get along with science and engineering. [Exercise 6] In the circuit of figure 2.8, when parallel circuits "L" and "C" resonate to power source frequency, please find the transient current "i" for adding alternating current voltage, " $e = E \cdot \cos(\omega \cdot t)$ ," whereas,  $t=0$ . All the initial values are zero, here.

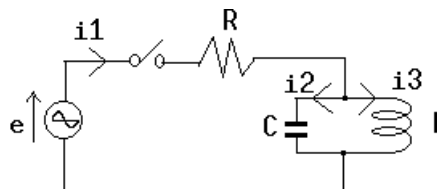

Fig 2.8

[Answer] When power source current is "i1," current in capacitor "i2," current in inductance "i3," the formulae found are the following three;

$$i_1 = i_2 + i_3 \quad (1)$$

$$R \cdot i_1 + L \cdot \frac{d(i_3)}{dt} = E \cdot \cos(\omega \cdot t) \quad (2)$$

$$L \cdot \frac{d(i_3)}{dt} = \frac{1}{C} \cdot \int i_2 \cdot dt \quad (3)$$

From the formula (3),  $L \cdot \frac{d^2(i_3)}{dt^2} = i_2/C$  and, from the meaning of the subject,  $\omega = 1/\sqrt{L \cdot C}$ . Therefore,

$$i_2 = (1/\omega^2) \cdot \frac{d^2(i_3)}{dt^2} \quad (4)$$

From the formula (2),

$$\frac{d(i_2)}{dt} = (E/L) \cdot \cos(\omega \cdot t) - (R/L) \cdot i_1 \quad (5)$$

By differentiating the above with t,

$$\frac{d^2(i_3)}{dt^2} = -(E/L) \cdot \omega \cdot \sin(\omega \cdot t) - (R/L) \cdot \frac{d(i_1)}{dt}$$

By substituting this for the formula (4),

$$i_2 = -(E/(\omega^2 L)) \cdot \sin(\omega \cdot t) - (R/(\omega^2 L)) \cdot \frac{d(i_1)}{dt} \quad (6)$$

By integrating the formula (5) with "t,"

$$i_3 = (E/(\omega^2 L)) \cdot \sin(\omega \cdot t) - (R/L) \cdot \int i_1 \cdot dt \quad (7)$$

From the formulae (6) and (7),

$$i_1 = -(E/(\omega^2 L)) \cdot \sin(\omega \cdot t) - (R/(\omega^2 L)) \cdot \frac{d(i_1)}{dt} + (R/(\omega^2 L)) \cdot \sin(\omega \cdot t) - (R/L) \cdot \int i_1 \cdot dt \\ = -(R/(\omega^2 L)) \cdot \frac{d(i_1)}{dt} - (R/L) \cdot \int i_1 \cdot dt$$

Therefore,

$$(R/(\omega^2 L)) \cdot \frac{d(i_1)}{dt} + i_1 + (R/L) \cdot \int i_1 \cdot dt = 0$$

By differentiating this with "t,"

$$(R/(\omega^2 L)) \cdot \frac{d^2(i_1)}{dt^2} + \frac{d(i_1)}{dt} + (R/L) \cdot i_1 = 0$$

The answer to this equation is in the formula of "t=A\*exp(g \*t)," whereas "i1=0" can be obtained by substituting initial conditions of "i1=0" when "t=0." Also, from the formula (6),

$$i_2 = -(E/(\omega^2 L)) \cdot \sin(\omega \cdot t)$$

and from the formula (1),

$$i_3 = (E/(\omega^2 L)) \cdot \sin(\omega \cdot t)$$

are obtained. In other words, transient current is not generated.

The above is the exercise and the answer. The key is that L and C are parallel resonance to the power source of sine waves. It is theoretical that "i1" becomes zero, since the impedance of L-C parallel circuit becomes infinite in the alternating current theory that regards the stationary state as important. However, when it comes to transient state, it does not seem suitable to have the answer that "i1" becomes constantly zero and the transient current does not occur.

Suppose the answer is correct, the following question arises;

How can the energy of the currents "i2" and "i3" that have not existed in the initial state be transferred from the electric source?

Also, as long as "i1" is zero, there is no loss of energy from the electric source. If so, it is possible with this theory to make an electric stove that does not require electric power, by giving energy to L-C parallel circuits and then extracting energy by connecting "R" to L-C parallel circuits.

That means you can generate energy without any compensation, which is against the principle of the conservation of energy, the basic of physical science. But, I assume this exercise is not a groundless writing because the book has been written by an expert in the field for education in a specialized course of the electrical engineering department of a university.

### Mystery about Pulse Transmission Distance - EIA-422

In pulse transmission by cable, the longer the distant is, the more difficult it is to transmit pulse quickly. For example, in the appendix of "RS-422-A," it is recommended to use a figure as shown below as conservative guide of selection;

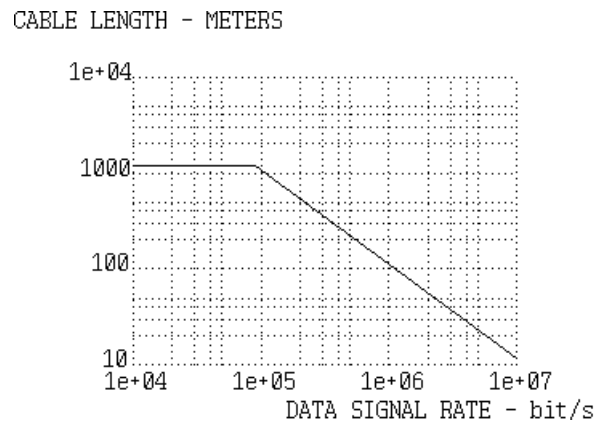

Then, it is honestly confessed that, in this standard, this figure is based upon empirical data and has been made from the following criteria, where telephone cable of copper conductor (24 AWG, 52.5 pF/m) terminated at the resistance of 100 Ω is used;

- a. Rise and fall times of pulse are the half of pulse width,
- b. Voltage fall from signal to load is below 6 dB.

The criterion of being up to the half of pulse width may be acceptable, since "slow speed of rise and fall is good enough as long as they catch up with speed of pulse." Meanwhile, they have left no doubt about that "voltage fall up to the half may be acceptable" by judgment in a traditional way of the electric engineering field. The Supreme Court of Japan has made a precedent that two constituencies are equal even if one of them has more than twice as many voters as the other. In the field of engineering, however, there is a tradition that they do not regard two things equal if their proportion is bigger than 1:2, which everybody except lawyers may think appropriate.

Now, regarding theoretical bases of the above figure, it is easy to imagine that the limit of the cable length, which is "constant" up to 1.2 km at the transmission speed of less than 90 kpbs, is caused by direct current resistance. That is because this straight line "is stretched up to direct current."

Let's confirm this by calculation here. Direct current resistance of 24 AWG copper conductor is 0.0842 Ω/m, which is doubled in a round-trip.

Meanwhile, the impedance of the transmitter and the receiver is 100 Ω respectively. Also, the input voltage of the receiver falls to 1/2 in direct current, when the direct current resistance of the cable reaches 200 Ω. Since this point is set as the limit of the cable length, the formula of;

$$\text{the limit of the cable length} = 200 / (0.0842 * 2) = 1200 \text{ m} \quad (1)$$

corresponds to the above figure. In other words, this territory is fixed with the criterion (b).

The matter is the straight line over 90 kbps. The line which is based on the criterion (a) shows that it becomes difficult more and more to make rapid transmission with long cables, because the longer the cable is, the slower the waveform of pulse is to rise or fall. The figure shows that experiments with cables of different length have revealed the above result.

However, as experimental data, such relation of inverse proportion as;

$$\text{the limit of cable length} = 1.2 e^8 / s \text{ (m)} \quad (2)$$

where

s = transmission speed (bit/s)

looks so neat that it suggests that "there is somewhat simple and strong theoretical basis." In other words, it does not seem to be a mere experimental or empirical law.

Besides, a defect of experimental data is their lacking generality. For example, this standard shows only the data about one kind of electric cable, 24 AWG telephone cable, but does not show;

- 1) how they are with cables of different sizes,
- 2) how they are with other structures.

Therefore, it is quite dubious as an index of selection.

Is a relation like (2) really explainable only experimentally or empirically? Do we have to give up pursuit of theoretical bases, like the author of "EIA-422-A" and many other writers who have referred to or quoted this guideline, and to shelter ourselves in an uncomfortable "empirical" world?

This is the question this time. Introducing this kind of writing is a good aspect of US standards, that does not happen with Japanese standards. Japanese standards are somewhat useless on principles of too much favor to influence exerted from the authority and of too much memory work, which is most likely in a bureaucratic country.

(Note) The same kind of experimental data can be found in the standard of "EIA-423-A" and in some books such as "Computer Data Communication Technology" by John E. MacNamara (CQ Publishing).

### The Relation between Risetime of Pulse and Length of Cable

The figure 1 shows typical step-responses of a cable, in other words, voltage waveform at the load end of the cable when voltage is suddenly added at the another end of cable. This is the basic of pulse transmission waveform, because, with step-responses, you can calculate output of any waveforms.

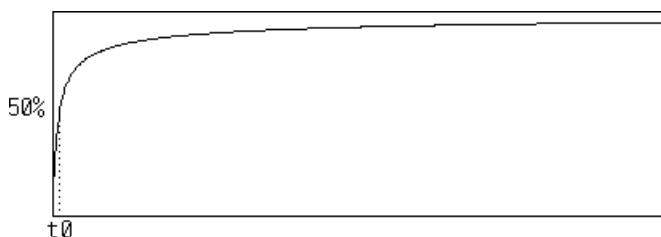

Fig. 1 step response of relatively short cable

Please be noted that this is a very general type of waveform which forms with good quality cables under any conditions. Some people may think that they have seen sharper waveforms than this. Once enlarged, though, they are the same waveform as this.

Now, I assume almost everybody knows that, the longer the cable is, the more time the transmission of pulse waveform takes to rise due to waveform weakening. For example, the figure 2 shows how it is with slightly longer cable of the same kind as the above;

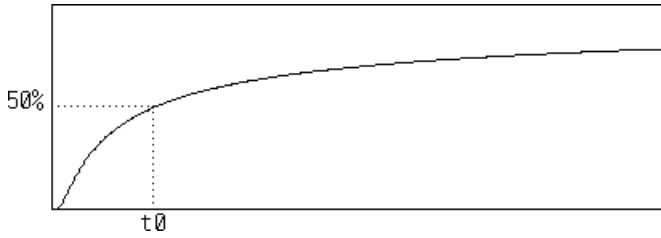

Fig. 2 step response of more longer cable

Risetime, which is defined as the time to reach from 10% to 90% in ordinary circuits, is often used as an index to see how pulse waveform weakens. In case of cables, however, the waveform rises sharply in the beginning of rise and slowly at the end. So, let's define "risetime" of pulse waveform of cable as the time to reach to 50%, here. In the above figure, "t0" is the risetime.

If you do not like this definition, please use the following relation which is formed with typical cables so that you can convert it to risetime of ordinary circuits;

$$10-90\% \text{ risetime} = 28.6 * 50\% \text{ risetime}$$

Here, "=" means "approximately" equal. Exactly speaking, it is 28.64..

By the way, it must be easy to understand by the linear circuit theory that waveform weakening in cable transmission is caused by attenuation distortion and phase distortion of cables. These distortions are proportionate to the length of the cable. For example, if the cable is doubled, so is attenuation.

### The Calculation of Inductance in IEEE Std 518-1977

The simplest case of electromagnetic interference (noise) is the one caused by common impedance coupling. There is a comment "IEEE Std 518-1977: IEEE Guide for the Installation of Electrical Equipment to Minimize Electrical Noise Inputs to Controllers from External Sources," as follows:

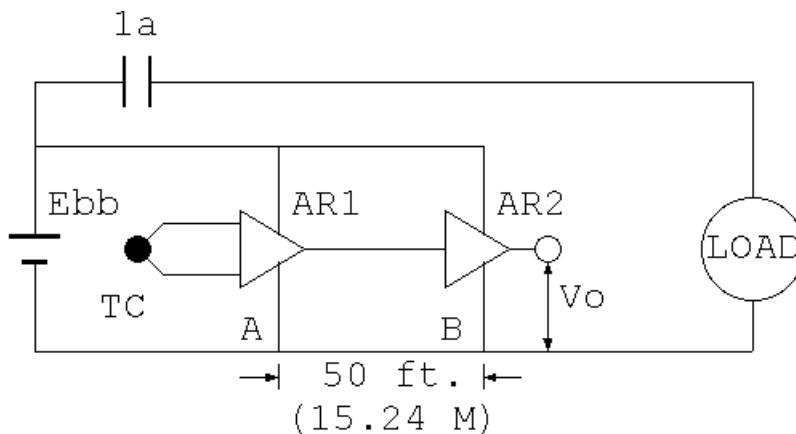

Fig 2 Single-Ended Circuit with Long Common Wire

The title of the Figure 2 means "unbalanced circuit sharing a long wire," where "TC" is a thermocouple, "AR1" and "AR2" amplifiers, and "1a" a contact to turn on and off "load" by using power source "Ebb." An electric wire of 50 ft long and of 12 AWG conductor size is used to connect "A" and "B," and is also commonly used by the thermocouple amplifier and the loaded control circuit which is controlled by the mechanical contact.

There are two subjects that this standard argues in this example, one interference of direct current and the other interference of transient phenomena.

Regarding the interference of direct current, the induced electromotive force between "A" and "B" by loaded current is 0.040 V, if the loaded current is 0.5 A, because the direct current resistance of the electric cable between "A" and "B" is 0.08 Ω. Then, provided that the amplification ratio of "AR2" is 100, the error is, it says, approximately 4°F around 100°F of iron-constantan thermocouple. This must be easily confirmed.

Regarding the interference of transient phenomena, they consider to open the contact "1a" that has been closed. As the current changes from 0.5A to 0 in 1μS, self-inductance must be considered in case of mechanical contact. Therefore, the following formula:

$$L = 0.002 * l * (\log(2 * l / r) - 3/4) \text{ (}\mu\text{H)}$$

where

L = self-inductance of a straight conductor

l = length of wire (cm)

r = radius of conductor (cm)

is presented as "self-inductance of a straight wire at high frequency." Under these conditions, l = 1524 cm and r = 0.205 cm and, therefore,

$$L = 3.05 * \log((2 * 1524 / 0.205) - 3/4) = 27 \mu\text{H}$$

Furthermore, considering the following circuit characteristic of inductance:

$$V_{ab} = L * (di/dt),$$

it is concluded that the following voltage is generated,

$$V_{ab} = 27e^{-6} * (0.5 / 1e^{-6}) = 13.5 V_{\text{peak}}$$

Regarding this formula of inductance, they say "normally inductance is a property attached to a complete circuit, but it is possible to attach a value of inductance to each segment making up a circuit. By this method, it is possible to calculate the induced electromotive force on the basis of time variation of the current," and conclude that the formula has been drawn from the following document,

Grover, F. W. - Inductance Calculations

New York: Van Nostrand, 1944, p35, Equation (7)

The "IEEE Stds," are the bases of electric and electronic technology of the world. Nonetheless, is the above calculation of "Vab" really reliable? For example, if the length of the wire is continued to be shortened, you may get negative figures eventually, which sounds strange.

### The Effect of Twisted Pair

In a little brochure titled "The Attachment to a General Catalog for Data Communication, LAN, Peripheral Device for Computers, Industrial Computers, and Softwares - Preserved Catalog Exclusive for Cables" which has been direct-mailed to me, there is a writing, "RS-232C Transmission Cable for Long Distance, Double-Strengthened Aluminum Shield, Countermeasures for RF1/EM1, UL, CL-2 Standards." The following statement of virtues is attached to the writing, though the Japanese translation from English is a little bit difficult to read:

The length of RS-232C interface is usually limited to 15 m at most. It is necessary to use a balanced interface like RS-422 or a local modem in order to extend it over the length. It is possible, however, in case of transmission distance of less than 150 m and the speed of 9600 bps, to extend the length by using special cables of low electrostatic capacity made in U.S.A. Long distance transmission cables of CC27 series are of very low electrostatic capacity because of their insulators of low dielectric rate. As a result, weakening of waveform at risetime and falltime is low, and direct current resistance and attenuation are both little because of the conductors of AWG 34 twisted pair wires. Meanwhile, the spurious (unnecessary radiation) towards outside is controlled to the minimum by using double-strengthened aluminum shield, which means it is strong against noises from outside, too.

It is followed by the following questions and answers:

Question: Why is it possible with long distance transmission cables to extend the length over 15 m stipulated in RS-232C standard? Answer: Ordinary computer cables have some problems such as weakening of output waveform of signals and errors due to crosstalks in case of transmitting high-speed data in a long distance, because they have big mutual-capacitance (electrostatic capacity). Meanwhile, long distance transmission cables have very little electrostatic capacity and low direct current resistance due to thick conductors of AWG 24.

That is why it is possible to extend it even by 10 times of the stipulated length. Question: Are they strong against noises? Answer: They are of little unnecessary radiation (spurious) because of the shields of strengthened aluminum foil to cope with RFI (Radio Frequency Interference) and EMI (Electro Magnetic Interference), and are strong against noises from outside as a result. Question: Is the conductor made of twisted pair? Answer: Of course, it is. The wires are assorted by color, which makes it easy to distinguish them in manufacturing cables.

Now, the summary of the specification of "ANSI/EIA-232" is as follows:

#### Driver

The maximum output voltage  $\pm 15$  V (no load)  
The minimum output voltage  $\pm 5$  V (3 k $\Omega$  load)  
The slew rate less than 30 V/us

#### Receiver

The maximum input voltage  $\pm 25$  V  
Input resistance more than 3 k $\Omega$ , less than 7 k $\Omega$   
Threshold voltage  
Logic 0 (ON) more than +3V  
Logic 1 (OFF) less than -3 V  
Effective load capacity less than 2500 pF

The maximum transmission speed 20 kbps

The area between -3 V and +3 V is a transient area without logic fixed. There is a rule that data signals must pass through the area in 4% of nominal signal interval (3 % in case of V.28) and control signals in a second, which fix the upper limit of output impedance of the driver.

There is no relation between capacitance and weakening of waveform in ordinary cable transmission. "RS-232," on the other hand, does not match characteristic impedance of the cable and impedance of the driver or the receiver, and therefore, the rise of waveform is controlled by the product of output impedance of the driver (exactly speaking, parallel composite resistance of output impedance of the driver and input impedance of the receiver) and load capacitance including the cable. So, the total capacitance is limited at lower than 2500 pF. Accordingly, it becomes possible to use it for a long distance by using cables of low capacitance.

However, the input impedance of the receiver is ranged between 3 k $\Omega$  and 7 k $\Omega$ . So, the direct current resistance in a round-trip is only 86  $\Omega$  which is about 3% of 3 k $\Omega$ , even if 28 AWG conductor that has 1/2.5 cross-section area of 24 AWG in this advertisement is used for 200 m. Therefore, the low direct current resistance argued in the statement of virtues does not mean very much.

It is not necessary to think too much about the shield, for the voltage amplitude is big and the slew rate is limited. It is easy to imagine that cables without shield are used in most environments, when you see for example "10 Base-T" with more strict conditions being used without shield. Regarding shields, I have seen an advertisement of another manufacture, saying "our cables without shield are easy to do terminal manipulation such as connecting, dividing, etc." It is interesting to see various ways of marketing (Note 2).

Now, the "twisted pair" stressed in this statement of virtues is cables made of two wires twisted together in order to, most importantly, reduce mutual inductance between wires and crosstalks of signals. This manufacturing method is one of the most basic technologies to cope with crosstalks. So, it may be as important as the advertisement argues.

Despite that, though, most "RS-232" connections are by ordinary cables without twisted pair and do not seem to cause any problem.

## Risetime of Pulse Waveform and Frequency Area

The following is a relational expression between risetime of pulse waveform and the highest frequency components contained in spectrum;

$$F_{\max} = 0.35/T_r$$

where

$T_r$  = risetime of pulse (s),

$F_{\max}$  = the highest frequency components (Hz).

The expression has been mentioned without any explanation in a large number of documents as if it is a matter of course. I do not think its basis is self-explanatory at all.

I think you can see intuitively that waveforms of speedy risetime have high frequency components. However,

- 1) the reason why  $F_{\max}$  and  $T_r$  are in an inverse proportion, and
- 2) what is the basis of the constant "0.35,"

## The equivalent circuit of open cable

When a cable is terminated with a load impedance  $Z_t$ , it is well known that the reflection coefficient at the load end is expressed as follows.

$$r = (Z_t - Z_0)/(Z_t + Z_0)$$

where

$r$  = voltage reflection coefficient ( $-1 \leq r \leq +1$ )

$Z_0$  = characteristic impedance of the cable ( $\Omega$ )

$Z_t$  = load impedance ( $\Omega$ )

If  $Z_t = Z_0$ , all the transmitted energy is absorbed in the load without reflection ( $r = 0$ ).

On the other hand, if the load impedance becomes to zero, all the transmitted energy is reflected at a reverse phase ( $r = -1$ ).

Now, is it right to think that a load of infinite impedance is connected to the end of cable, in case of a so-called "open cable" where nothing is connected to the end of the cable ?

In other words, are the following Fig. 1 and Fig. 2 equivalent to each other ?

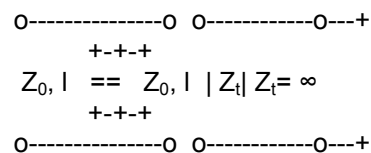

Fig. 1 Fig. 2

That is the question.

In fact, these two are treated as equivalent to each other in many literatures. And what is more, if the terminal is not connected, there should not be any current flowing at the end of the cable and also,

Impedance = voltage/current

Therefore, it seems to be right to think, "it surely is infinite and there is no need even to examine it." in consideration of the load impedance.

## Cascade connection of coaxial cables

Cascade Connection of Coaxial Cables When coaxial cables of the same characteristic impedance but of different sizes (different diameter), are connected in series, do electromagnetic waves have reflection at the connecting point? Or, is it right to think of no reflection?



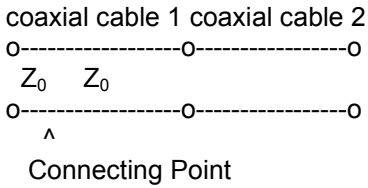

Of course, the connecting point must be structured with the best effort, because a bad connection naturally causes big reflection. It is assured in textbooks on "Transmission Theory" that, when a line of characteristic impedance, Z<sub>0</sub>, is connected to a line of characteristic impedance, Z, in series, the voltage reflection constant at the connecting point is as follows:

$$r = (Z/Z_0 - 1)/(Z/Z_0 + 1)$$

where

r = Voltage reflection coefficient

Z<sub>0</sub> = Characteristic impedance of Line 2 (Ω)

Z = Characteristic impedance of Line 1 (Ω)

This well-known relation implies that reflection of electromagnetic waves is determined only by the characteristic impedance of the lines and, therefore, there seems to be no reflection in the above circuit as a matter of course. If so, we may not need even to take the matter into consideration. However.

### Reflection and Transmission Speed of Electromagnetic Waves

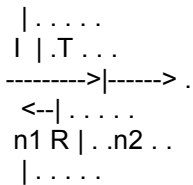

A ray of light (electromagnetic waves) (I) that vertically comes to a medium with refractive index, n<sub>2</sub>, from a medium with refractive index, n<sub>1</sub>, partly makes reflection and the rest passes through. It is well known that the reflection constant, namely the ratio of the reflected waves to the incident waves, can be expressed as follows, when compared in terms of volume of the electric field (note 1):

$$E_r/E_i = (n_1 - n_2)/(n_1 + n_2) \quad (1)$$

where

E<sub>i</sub> = Strength of the electric field of incident light (V/m)

E<sub>r</sub> = Strength of the electric field of reflected light(V/m)

n<sub>1</sub> = Refractive index of medium 1

n<sub>2</sub> = Refractive index of medium 2

The value has to be squared when compared in terms of the strength (energy) of light. In case of incidence from air to water, for example, the reflexivity is approximately (1/7)<sup>2</sup> = 2 %, where n<sub>1</sub> = 1 and n<sub>2</sub> = 1/7, and most of the light passes through. This is the reason why water looks transparent.

Now, the (absolute) refractive index is defined as follows:

$$n = v / c$$

where

n = Refractive index

v = Propagation speed of electromagnetic waves in the medium(m/s)

c = Light velocity in a vacuum (3 × 10<sup>8</sup> m/s)

So, the expression (1) can be rewritten as follows:

$$E_r/E_i = (v_1 - v_2)/(v_1 + v_2) \quad (2)$$

where

$v_1$  = Propagation speed of medium 1 (m/s)

$v_2$  = Propagation speed of medium 2 (m/s)

In other words, there is no reflection if propagation speeds of two mediums are equal. If currents on both sides of the boundary have the same speed, everything that has reached the boundary flows away through the boundary: that is a conclusion easy to understand intuitively.

Now, here is the question. The relation between reflection and permeation of electromagnetic waves at a connecting point of cables looks quite similar to the above. Is it right to think in this case too that, if propagation speeds on both sides of the connecting point are equal, there is no reflection?

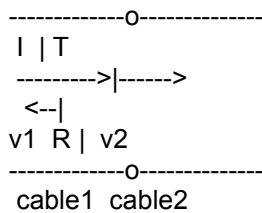

If not, how is it different from the aforementioned case of light?

Note 1 - Reflection of Light

This matter is mentioned in many books. Read the following books, for example. They are masterpieces with full of excitement.

Richard P. Feynman,- Robert B. Leighton and Matthew Sands - The Feynman Lectures on Physics, Vol.1, 3306

Richard P. Feynman,- Robert B. Leighton and Matthew Sands - The Feynman Lectures on Physics, Vol.2, 33-5

Vernon.D.Barger and Martin.G.Olsson,- Classical Electricity and Magnetism  
A contemporary Perspective, 9-54  
(Allyn and Bacon) ISBN 0-205-08758-2

# Fadel Art

## The Basic Theory

The fadel art technologies are consequently the results of the basic philosophy of Mr. Fadel. That means all our technologies have the target to fulfil the Heaveside conditions, to guarantee the best possible phase and impedance correction and to realize high end audio products which are optimized for their specific use.

First in most of our cables we are using the Litz wire technology or an equivalent construction in order to avoid the undesired skin effect. Furthermore to eliminate the Eddy current in copper we are selecting a very high purity copper with a long-crystal structure. Our final operation consists in measuring the resulting parameters in a given structure with an impedance analyser from DC to 1 MHz. To achieve the optimum correction we take in consideration the Heaveside conditions in order to realize a distortionless cable.

In the Heaveside formula the only parameters we can modify are the line conductance and the line impedance. Therefore we developed a technique increasing both the inductance and the conductance by weakening the insulation by a specific method. For this we have developed a very special magnetic material consisting of an carbon-iron powder which is defined by pure iron particles with a very precise particle structure of a perfect spherical shape. This material has no magnetic remanence, a very high temperature stability and, in contrary to most magnetic materials, a very high resistivity as well as a very low permeability.

Furthermore fadel art has introduced for the first time the measuring parameter "Alpha" as a specific characteristic for audio cables, which defines the amount of energy which is consumed inside a cable while a signal is passing the cable. Therefore this parameter is specific only to the cable and is not influenced by the connected amplifiers and speakers. Consequently we have also developed a corresponding sophisticated computer software which, based on the measurements of the well known electric parameters, makes it possible to describe the conditions of Heaveside as well as to describe the measuring parameter "Alpha".

In 1998 fadel art has developed a really unique technology for the realization of high end audio cables to which was given the name "Silence Technology". This outstanding technology is based on the carefully made analysis of a specific phenomena which is influencing the acoustic transmission inside a cable and which goes back to the so called "Barkhausen Effect". This effect was up to now only known for magnetic materials, but now for the first time this effect was analysed by Mr. Fadel for non-magnetic materials like copper, which are used as conductors in cables. This technology is the first approach in the audio field to eliminate the noise which is created by the internal movement of the molecules. The products which are based on the "Silence Technology" are without any doubt the most sophisticated products ever developed by our company. The "Reference One" series are the first items using this entirely new "Silence Technology".

## Speaker Cables

FADEL ART is offering a wide range of high technology speaker cables to connect any kind of speakers to amplifiers.

All our speaker cables are optimized for their specific application and they are corrected in respect of Impedance, Phase and Time Delay. Furthermore all FADEL ART speaker cables are available in single-wiring, in bi-wiring, and on special request in tri-wiring versions. By the bi-wiring method the speakers are connected to the amplifier in respect to the low frequencies and to the high frequencies by separate cables.

In this way the electromagnetic interferences between the low and the high frequencies are minimized and the undesired intermodulation distortions are significantly reduced.

All our speaker cables are terminated with high quality connectors and the termination process is specially designed by FADEL ART. We deliver all our speaker cables as a choice with Bananas, Spades or Cable End Sleeves in order to meet every special demand of the end user.

Our latest contribution to the optimum speaker connection technology are the "Duo" versions of our best speaker cables. In the "Duo" models we are using totally separated cables for the both polarities "Plus" and "Minus". By this method the electromagnetic interferences between the two polarities are reduced to a so far never achieved level.

The FADEL ART speaker cables from the "Flex" Line are our current top range. The basic construction of the "Flex" technology consists of in total 24 blocks of 3 strands each in "Litz" topology. Each single strand is separately isolated by a very special CIMM Teflon (CIMM stands for "carbon iron modified material,") developed by FADEL ART .

The uniqueness of the "Flex"-technology is that blocks of the conductors are constructed in a way that they result in in two extremely stiff and vibration-free concentric tubes of an identical diameter. By this construction for the first time practically all magnetic disturbances are effectively eliminated.

For the more economic priced “Stream” cables we are using the same basic technology, but we have reduced the number of strands and we are using conductors with enamel insulation instead of the CIMM Teflon insulation.

The “StreamFlex” speaker cables are including the following models.

The “StreamFlex Duo” – the absolutely top model, combining the “StreamFlex” technology as well as the “Duo” technology.

The “StreamFlex Special” – the top of the “StreamFlex” technology, but not including the “Duo” technology.

The “StreamFlex Plus” – The most economic priced cable of the “StreamFlex” range.

The “StreamFlex” – The specially designed cable for top class high efficiency speakers.

The “Stream” speaker cables are including the following models.

The “Stream Duo” – The top model, combining the “Stream” technology as well as the “Duo” technology.

The “Stream” – The basic model with the “Stream” technology.

The FADEL ART “GreyLitz” speaker cable from the “Litz” line is our most economy priced speaker cable. This cable has a very good ratio between price and musical performance and gives to the user an excellent entrance to the world of high quality speaker cables.

The conductors are consisting of pure copper and are made in “Litz” topology. For the insulation we are using a special modified Polypropylene.

## Transporting Power in Audio Cables by Bruce Brisson and Tim Brisson

### 1. Introduction

The purpose of an audio cable in a High-End sound system is to transport musical energy between components as efficiently as possible. The rate at which energy flows is defined as power. Music Interface Technologies (MIT) has found that the power factor can be used as one measure of an audio cable's efficiency in transporting power from amplifier to speaker, for example. As we will show, the power factor is calculated using the impedance phase angle of the cable, and therefore cables that exhibit improper impedance characteristics will have a poor power factor.

Along with the power factor, this paper will focus on the fact that music signals are AC (oscillatory) signals, not DC. In an audio cable, both inductance and capacitance are present. Energy in an audio cable is stored in two forms: in the magnetic field of the inductor and as an electric field in the dielectric of the capacitor. There is a periodic transfer of energy from magnetic form to dielectric form, and vice versa, producing electric oscillations. To understand this, the mathematics of AC analysis, such as complex impedance and complex power, must be used.

Furthermore, this paper will show that the impedance of a cable is determined not only from the resistive elements of a cable, but also from the cable's reactive or energy storage elements, namely its capacitors and inductors.

Finally, we will show that the power factor is a function of the impedance of the cable's reactive elements.

If the mix of capacitance and inductance in a network is not properly chosen, then audible distortion can result. An audio network is any combination of resistance, capacitance, and inductance designed to transport audio signals, such as an audio interface cable. Since capacitors and inductors oppose voltage and current changes, respectively, then an improper amount of the two will cause the network to "resist" voltage or current changes too much or too little, relative to each other. This can be observed by plotting the voltage and current as functions of time. Improper amounts of capacitance or inductance will cause either the voltage or current to be shifted on a time plot. This time shift, when measured with respect to the frequency of the input signal, is known as a phase delay, and when measured with respect to the period of the input signal, is known as the phase angle. Improper phase delay characteristics can cause a number of problems, including signal distortion (a subject of a future paper) and the focus of this paper power distortion.

This paper examines the significance of the phase angle between the voltage (capacitance) and the current (inductance) in passive coupling networks such as audio interface cables. Through the phase angle, insight is gained into the role the reactive elements play in a network that is storing and transporting power to a load. Actual test and measurements show how networks with an improper phase angle have problems transporting power.

Furthermore, we show how these problems can be directly analyzed by introducing and using the power factor. The power factor is shown through measurements, calculations, and plots to be an effective method of characterizing an audio cable's efficiency in transporting power to a load.

## 2. Energy Storage Elements in a Network

Proper test and measurement procedures can be used to help characterize the performance of cables and coupling networks. By fully characterizing a cable or coupling network, its performance in an audio system can be specified. However, to clearly understand and interpret the results, we must first understand what it is we are measuring. Therefore, before we begin our study of power, let's take a closer look at the role capacitance and inductance play as energy storage elements in a network, specifically as related to power. Because power is defined as the rate of flow of energy, elements that store (and release) energy must have an impact on the quality of the power that is delivered to the load.

### Capacitance

A capacitor is generally defined as two parallel conducting plates, usually with a dielectric between them; the symbol is shown in Fig. 2-1. Audio cable is constructed similarly, usually in one of three ways: a two-conductor cable (zipcord, for example), a coaxial cable (a center conductor surrounded by a braided shield), or a twisted pair. In most High End cables, including MIT's, the construction is usually a twisted pair the two conductors being twisted around one another.

The shunt (or parallel) capacitance in an audio cable arises from the proximity of the two conductors. From the point of view of capacitance, a two-conductor audio cable can be thought of as two long, skinny parallel plates close to each other. To understand how a capacitor stores energy, imagine the following: Suppose a battery is connected to a capacitor, as in Fig. 2-2. When the switch S is closed, almost instantly the capacitor will be "charged," that is, positive charges will accumulate on the side of the capacitor connected to the positive side of the battery, and negative charges will gather on the side of the capacitor connected to the negative side of the battery. Now there is a "separation of charges." The positive and negative charges are separated by the distance between the plates. The theory of electrostatics tells us that any separation of charges creates an electric field, as shown in Fig. 2-3. If this is an ideal capacitor, when the battery is disconnected the charges will remain on the plates, and thus the electric field will remain. Since an electric field is a form of potential energy, energy has been stored in the capacitor. Electrostatic energy in an audio cable is stored in its shunt capacitance.

The mathematical definition for capacitance (C) is

$$C = \frac{Q}{V}$$

where Q is the amount of charge on one plate in coulombs, and V is the potential difference between the plates in volts. The unit of capacitance is the farad (F).

If the value of capacitance C does not remain constant with different values of applied voltage, then the capacitor is said to be non-linear. If the value of the capacitor changes with the applied frequency, then the capacitor is time-varying. Therefore, an ideal capacitor is linear and time-invariant. The symbol for a non-linear capacitor is shown in Figure 2-4. A linear capacitor will have superior power characteristics when compared to a non-linear capacitor.

(In general, a component that is either non-linear or time-varying is simply said to be non-linear)

The material between the two plates is known as the dielectric, or insulator. Typical dielectrics include air, various plastics, Teflon, mylar, paper, and rope or twine. Glass and Styrofoam are also good insulators.

Ideal dielectrics, such as a perfect vacuum, conduct no electricity, as shown in Figure 2-5. Thus, ideally, there would be an open circuit (infinite resistance) between the plates of a capacitor. In the real world, however, the dielectric has some finite resistance, and therefore is not a perfect insulator. This allows some of the electric charge to "leak" between the plates, as shown in Figure 2-6, and is aptly known as the leakage current.

The function of a dielectric is to store energy. As we said earlier, energy is stored in a capacitor between its plates. Since the dielectric is between the plates, energy is stored in the dielectric. Therefore, if the dielectric allows leakage current, then energy is being lost. This would then be a lossy capacitor. Lossy capacitors have poor power transfer characteristics.

## Inductance

Inductance is one of the least understood, but most important, properties of audio cable. Typically, most High-End cable companies use the highest quality dielectrics when constructing their cables. Therefore, most High-End audio cables have good capacitive characteristics, as related to power. However, most widely miss the mark when it comes to the required inductive component. **Without a proper inductive component, current cannot be stored, and the cable will have difficulty transporting active power to the load.**



An inductor is usually constructed as a coil of wire, and the symbol for an ideal (linear) inductor (Figure 2-7) reflects this. A coil acts as an inductor through a property called self-inductance commonly called simply inductance, the tendency of a current in a loop to maintain itself.

Current flowing through a coil produces a magnetic field, as shown in Figure 2-8. An inductor opposes changes in current through the following process: If the current in the first turn of the coil changes, the magnetic flux it produces around it also changes, and a voltage is induced in the adjacent turn (changing magnetic fields create electric fields and thus voltage potentials). But since a voltage has been induced into the neighboring turn, current has also been induced into it. But the increased current in the adjacent turn creates more magnetic flux around itself. Now this increased magnetic flux around the second turn tries to induce more current back into the first turn, thus attempting to oppose the initial rise in current. While the capacitor stores energy in its electric field, the inductor stores energy in its magnetic field.

The mathematical relationship for inductance (L) is given by

$$L = \frac{v}{\frac{di}{dt}}$$

where v is the voltage potential across the inductor in volts, i is the current in amps, and t is the time in seconds. The symbol di/dt reads "change in current with respect to time." Thus, the equation for inductance relates the voltage across the inductor, to the time rate of change of current through it. The unit of inductance is the Henry (H). If the value of inductance L does not remain constant with different values of applied current, then the inductor is said to be non-linear. If the value of the inductor changes with the applied frequency, then the inductor is time-varying. Thus, an ideal inductor is linear and time-invariant. The symbol for a non-ideal inductor is shown in Figure 2-9.

Since a High-End audio cable is typically constructed with many coils of wire, constructing a cable is like constructing an inductor. In fact, it is during the winding process that the important element of inductance is added. Because proper inductive qualities are so important to a cable's performance, the inductive component must be artfully formed by carefully controlling the geometry of the windings during fabrication. Inductance is controlled by the size, spacing, and length of the wires, the bundle and conductor size, and how many turns are wrapped per unit length (angle of lay).

2-10 shows the magnetic field produced by a straight wire. Notice that the field lines do not cross, or cut, through the wire at any point. This shows that a straight wire has poor self-inductive qualities. But look how the field lines in the coil of Figure 2-11 cut through the coil many times. The field lines around an inductor give a direct indication of how much inductance the inductor is producing. The more flux lines produced for a given input, the more inductance is produced, and the more current is stored in the inductor. Thus a coil has more inductance, and therefore stores more current, than a straight wire.

**Audio cables constructed mainly of straight wires have poorer inductive characteristics than coiled cables which means that straight wires have poorer power characteristics than coiled cables.**

Many of MIT's proprietary techniques, patents deal specifically with constructing audio cable in a manner that creates optimum self-inductive qualities.

### 3. Overview of Impedance Definition

Impedance is defined as the opposition to alternating current flow. Since the purpose of audio cable is to pass musical signals unopposed (or uniformly opposed), understanding impedances in cable is crucial. It is from the impedance characteristics of a cable that the cable's performance can be calculated.

It is outside the scope of this paper to fully explain impedance in fact, impedance will be the subject of a subsequent paper. For further information on this subject, or complex numbers, references on these subjects are included in the bibliography.

#### DC vs. AC Impedance

In the introduction, we stated that musical energy in a cable is AC energy. It is therefore improper to characterize audio cables using DC methods. One of the most common mistakes in analyzing audio cable is to use a standard multi-meter, which measures the DC resistance of the cable. The impedance of audio cable must be determined using an AC impedance analyzer. This type of equipment measures the impedance of a device at a specific frequency and gives not only the magnitude of the impedance, but also the phase angle of the impedance. As we will see shortly, it is this measured phase angle that is of great interest to us - we will use it to calculate the power factor.

#### Conventions

In this paper, impedance will be represented in phasor notation; that is, impedance is given in polar coordinates as a vector of magnitude  $Z$  and phase angle  $\theta$ . The unit of impedance, whether purely resistive (as an ideal resistor) or reactive (as with energy storage elements), is given in  $\Omega$ .

If Figure 3-1 had a length of 1 and a phase angle of  $45^\circ$ , the phasor notation would then be written

$$\vec{Z} = 1\Omega \angle 45^\circ$$

and read as: "An impedance of 1  $\Omega$  at  $45^\circ$ ."

#### The Role of Impedance in Audio Cables

The key to understanding the behavior of a network, such as an audio cable, lies in understanding its impedance characteristics. Once the impedance is known, all else follows power characteristics, transfer functions, etc.

### 4. Impedance Characteristics of Capacitors: Ideal case

An ideal capacitor has an impedance phase angle of  $-90^\circ$  that remains constant with frequency and applied voltage. This means that the voltage across a capacitor falls behind, or "lags," the current going through it by  $90^\circ$ , or one-quarter of a cycle. Since a capacitor opposes changes in voltage, it makes sense that the voltage is delayed behind the current. Appendix A, Figure 2, shows the relation between voltage ( $v(t)$ ) and current ( $i(t)$ ) for an ideal capacitor. Note how the peaks in the current waveform are a quarter-cycle to the left of (leading) the voltage waveform.

Appendix A, Figure 1 shows an impedance plot for the ideal capacitor on the complex plane. Since the phase angle is  $-90^\circ$ , the capacitive-reactance vector points straight down. The phasor for an ideal capacitor is then:

$$\vec{Z}_c = X_c [\Omega] \angle -90^\circ$$

Note: The impedance of a capacitor is not constant to frequency, as is an ideal resistor. This is because capacitive reactance changes with frequency.



## Non-Ideal (Practical) Case

The non-ideal model takes into account the real-world losses of the dielectric. This is done through the use of parasitics, as shown in Figure 4-1. Parasitics are unwanted adjuncts of wanted circuit elements, such as resistance or inductance. All real-world components have parasitics. The net effect of parasitic resistance normally seen in audio cables is the loss of one-half of one degree, to one and one-half degrees off the capacitance phase angle. Typical values for parasitic resistances ( $R_p$ ) are usually on the order of several  $M\Omega$ , though these too can be frequency dependent and vary widely. However,  $-89.5^\circ$  is a typical non-ideal capacitance phase-angle value for an audio cable when measured at audio frequencies. Therefore, the capacitive component of high-quality audio cable normally does not vary far from the ideal within the audio frequency range. This is not the case with the inductive component, as we will see next.

## 5. Impedance Characteristics of Inductors: Ideal case

An ideal inductor has an impedance-phase angle of  $+90^\circ$  that remains constant with frequency and applied current. Opposite to the capacitor, the inductor's voltage leads the current by  $90^\circ$ . Or from the other point of view, the current in an inductor lags the voltage by  $90^\circ$ . Using the same logic we applied to the capacitor earlier, since an inductor opposes changes in current flow, we would expect that the current in an inductor would be delayed one-quarter of a cycle. This is the compliment of the capacitor, where the voltage was delayed a quarter cycle. Appendix B, Figure 2 shows the voltage and current waveforms of an ideal inductor. Compare with Appendix 1, Fig. 2. The phasor for an ideal inductor is:

$$\vec{Z}_L = X_L [\Omega] \angle +90^\circ$$

where  $X_L$  is the inductive reactance, and is found from

$$X_L = 2\pi fL [\Omega]$$

where  $f$  is the frequency in Hertz (Hz), and  $L$  is the inductance in Henrys (H). Note that the inductive reactance changes with frequency, just like (but inverse to) capacitive reactance. The phasor diagram for an ideal inductor is shown in Appendix B, Figure 1. Note that it points straight up.

## Non-Ideal (Practical) Case

The non-ideal model takes into account two things: the resistance of the coil of wire and the capacitance between the inter-coil windings. The former is easy to understand; this is the resistance found from the measurements made with the impedance analyzer. But the latter is a little more difficult to understand. Recall from the discussion of capacitance that the proximity of conductors generated the cable's shunt capacitance. The windings of an inductor are in close proximity also. Therefore they have their own parasitic capacitance. Figure 5-1 shows this effect. Along with poor self-inductive qualities caused by improper winding techniques, the loss of inductive phase angle (and therefore power factor) seen at low audio frequencies can be attributed to parasitic capacitance between the windings of audio cable.

The real-world model of an inductor is shown in Figure 5-2. This model includes the resistance of the windings ( $R_s$ ) along with the parasitic capacitance ( $C_p$ ). While the parasitic resistance of the capacitor ( $R_s$  primarily) normally has the effect of knocking only a half-degree off the ideal  $-90^\circ$  reading, the effects of the parasitics on an inductor operating at low audio frequencies are much more dramatic.

Most audio cables have problems in this area between zero Hertz (DC) and 1 kHz. It is not uncommon for audio cable with poor inductive characteristics to lose nearly all of the inductive phase angle at low frequencies ( $<100$  Hz). Such a deviation from the ideal is shown in the non-ideal phasor diagram in Appendix B, Figure 3. This loss of inductive phase angle has tremendous implications on audio quality.

By coiling the wire of a cable in a tight loop, MIT helps to overcome the problems of self-inductance by creating proper amounts of inductance in the cable through proprietary patents and patent-pending winding techniques. Additionally, MIT achieves better inductive properties through mutual inductance.

Mutual inductance occurs when the flux of two independent, non-connected coils interact. Figure 5-3 shows this effect in a common transformer. In fact, mutual inductance is the basis for the operation of transformers. When the magnetic flux of two coils interacts in a positive (additive) manner, they have positive mutual inductance. When the magnetic flux of two coils interacts in a negative (canceling) manner, the two coils have negative mutual inductance. Mutual inductance is noted with the letter  $M$ , which has units of Henrys (H).

### **An Example: Parallel Mutual Inductance**

Figure 5-4 shows a pair of two-terminal networks constructed with coils wound in parallel. In this example, rather than mathematically derive the equivalent inductance, we will show how the network can be modeled with equivalent circuits.

Figure 5-5 shows the two coils of Figure 5-4 schematically, including their parasitic series resistance. Note how the coils (composed of the strands of copper wire within a multi-stranded cable) of Network A are wound in the same direction, while the coils of Network B are wound in the opposite direction. Figure 5-6 shows that Network A reduces to a series inductor/resistor combination. Since an inductor is present in the final equivalent circuit, a series impedance phase angle is present. This is necessary for a good power factor. Network B, however, reduces to a series resistor only in Figure 5-7. Therefore, a cable wound in the manner of B will produce no inductance, and therefore will hold no inductive phase angle. This will lead to a poor power factor. This is because all audio cables inherently have shunt capacitance, and an inductive phase angle is therefore necessary to balance the shunt capacitor's phase angle.

MIT has investigated many methods of winding audio cable to find the optimum techniques that produce proper inductive qualities necessary for audio cable to transport active power efficiently. Since inductance is such a misunderstood subject, as related to audio cables, MIT has committed itself to publish articles on this subject in a continuing effort to demystify it.

### **Non-Ideal (Practical) Case**

The non-ideal model takes into account the real-world losses of the dielectric. This is done through the use of parasitics, as shown in Figure 4-1. Parasitics are unwanted adjuncts of wanted circuit elements, such as resistance or inductance. All real-world components have parasitics. The net effect of parasitic resistance normally seen in audio cables is the loss of one-half of one degree, to one and one-half degrees off the capacitance phase angle. Typical values for parasitic resistances ( $R_p$ ) are usually on the order of several  $M\Omega$ , though these too can be frequency dependent and vary widely. However,  $-89.5^\circ$  is a typical non-ideal capacitance phase-angle value for an audio cable when measured at audio frequencies. Therefore, the capacitive component of high-quality audio cable normally does not vary far from the ideal within the audio frequency range. This is not the case with the inductive component, as we will see next.

## **6. Power**

When most people discuss power, they usually are speaking of DC power. In this case, the power is easy to calculate, it is simply the voltage times the current. However, we do not listen to DC on our audio systems. Therefore, it is incorrect to characterize audio cables used in transporting AC signals with DC mathematics. Unfortunately, the mathematics of AC power is more complicated than DC. Let us define the several types of AC power and how they apply to audio cables.

### **Types of Power**

#### **Power (General Definition):**

Power is the rate of flow of energy. The unit of power is the watt (W), which is one joule per second. Electrical power, in general, is calculated by multiplying voltage times current.

#### **Apparent Power:**

Apparent power is found from the product of the rms value of the applied voltage and the rms value of the applied current. Thus, as related to audio, apparent power represents the total value of the power supplied by the source.

### Instantaneous Power:

Instantaneous power is defined mathematically as:

$$p(t) = v(t) i(t) \text{ [W]}$$

Thus, this is the power being consumed or delivered by a device or network at one instant in time. The AC signals that compose audio can be expressed as sinusoidal functions of time.

The voltage is:

$$v(t) = V_{\max} \cos(\omega t + \theta_v) \text{ [V]}$$

and the current becomes:

$$i(t) = I_{\max} \cos(\omega t + \theta_i) \text{ [A]}$$

where  $V_{\max}$  and  $I_{\max}$  are the respective peak amplitudes of voltage and current, and  $\theta_v$  and  $\theta_i$  are the respective phase angles.

Then, by using trigonometric identities, the instantaneous power becomes:

$$p(t) = V_{\max} I_{\max} \cos(\omega t + \theta_v) \cos(\omega t + \theta_i)$$

Note that the final expression for  $p(t)$  is composed of two parts, a constant (or average) component, and an oscillating term that contains  $2\omega t$ . This term shows that instantaneous power oscillates at twice the applied frequency, as can be seen in the plot of Figure 6-1.

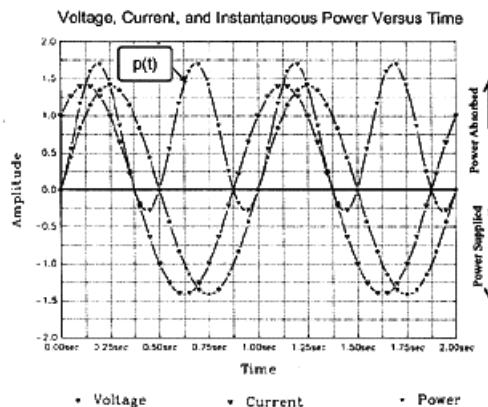

Figure 6-1. Plot of voltage, current, and the associated instantaneous power versus time. This shows that AC power is oscillatory in nature (unlike DC power), and changes sign four times per period, while the voltage and current waveforms change sign twice. For this plot, a network with an impedance phase angle of  $45^\circ$  was used to calculate the power values. Notice how the power plot oscillates mostly above the zero line, indicating that all of the power absorbed by the network has not been returned the signs of an inefficient network. Because the area of the power plot is not zero, this network has consumed power.

The sign for  $p(t)$  can be both negative as well as positive. A positive value for  $p(t)$  indicates that the device (or network) is absorbing the applied power, while a negative value shows that the device or network is supplying or returning power to the network. A note about terminology: Absorb and consume mean different things when applied to how electrical power is handled in different circuit elements. When power is applied to an ideal resistor, that power is actually dissipated as heat into the environment, never to return to the circuit. That is, a resistor consumes all of the power applied to it. An ideal capacitor or inductor, however, treats power differently. During the first quarter of a period ( $90^\circ$ ), when AC power is applied to a storage element, the energy is first stored in the element's energy field, an electric field in a capacitor and a magnetic field in an inductor. From the point of view of the power source, the power it has output to the network has now been absorbed. But during the second quarter of the period, all of the energy that was stored in the ideal capacitor and inductor is released (or "squirted") back into the network as power available for consumption by the load. This is different from the resistor, where power was dissipated as heat.

### Active power:

Active power (P) is of the most interest to us, since it is the power that is ultimately intended for consumption by the load. Active power is given by

$$P = \frac{1}{T} \int_0^T p(t) dt \quad [W]$$

where T is the period, in seconds, of the input signal.  
From this we obtain:

$$P = \frac{1}{2} V_{max} I_{max} \cos(\theta_v - \theta_i) \quad [W]$$

where  $V_{max}$  and  $I_{max}$  are the amplitudes of the voltage and current, respectively;  $\theta_v$  is the phase angle of the voltage; and  $\theta_i$  is the phase angle of the current. P is given in units of Watts (W). The familiar unit of watts suggests that this is the type of power we should be most interested in, since this is the power that is ultimately consumed by the load. Notice that unlike DC, the power in an AC circuit cannot be found simply by multiplying voltage and current; the respective phase angles of voltage and current must also be factored in. Because active power has the cosine function in it, it is defined as in-phase power.

A cable should accept the input apparent power and transport it as active power to the load. Active power is also known as average power, since it is the average amount of power that is consumed or supplied over one period of the input signal. It is important to note that not only does active power depend on the amplitudes of voltage and current, but also on the phase difference between them! Therefore, a change in the phase angle of the voltage or current can change the value of active power. This is different from DC, where the value of power depended only on the magnitudes of voltage and current.

### Reactive power:

Reactive power (Q) is power that is temporarily stored in the reactive elements in a cable and returned back to the network. Reactive power is given by

$$Q = \frac{1}{2} V_{max} I_{max} \sin(\theta_v - \theta_i) \quad [VAR]$$

where the unit for Q is Voltamperes reactive (VAR). Reactive power is also known as quadrature power, hence the Q (do not confuse this Q with the quality factor Q used in amplifier and filter design. There just are not enough symbols to go around!). Q, like P, also depends on the phase angles of voltage and current.

### The Role of Active & Reactive Power in Audio Cables

In the introduction, we stated that capacitors and inductors are energy-storage elements. In terms of power, this means that ideal energy storage elements do not consume power, rather, they only temporarily store reactive power, as shown in Figure 6-2. Compare with the power characteristics of a resistor (Figure 6-3), in which all power is dissipated and none is stored. Thus, in an ideal audio cable, the power transportation process is this: The cable will absorb the input apparent power and store the voltage in its shunt capacitance and the current in its inductance as reactive power. This reactive power is then returned back to the network as active power that is transported onward to the load for consumption. If the proper amounts of capacitance and inductance are present, all of this will happen in phase with the applied signal, and active power will be supplied to the load. We will show in the following chapters what happens when the amounts of reactance are not proper.

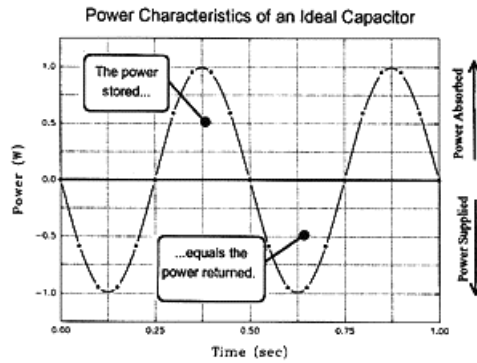

Figure 6-2. The power characteristics of an ideal capacitor. Since the power plot oscillates evenly above and below the zero line, the power stored cancels the power absorbed the net effect is that an ideal capacitor consumes no power. The same is true for an ideal inductor.

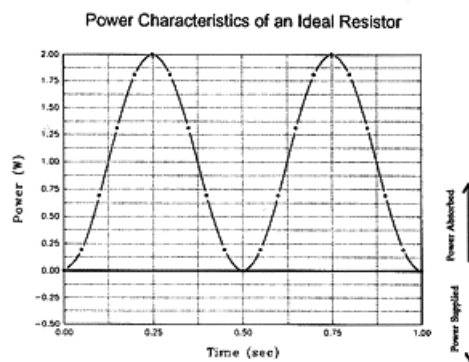

Figure 6-3. The power characteristics of an ideal resistor. Since the power plot oscillates completely above the zero line, an ideal resistor consumes all of the power input to it.

## 7. The Power Factor

In the previous chapters we have made the point that a cable with poor impedance phase characteristics will have problems transporting active power, because improper phase angles will lead to an undesirable power factor. In this chapter, we will put everything together to show how the phase angles and power factor are related.

The question arises, how are these phase angles measured? Recall from the phasor form of Ohm's law that the phase difference of the voltage and current is equal to the phase angle of the impedance:

$$Z \angle \theta_z = \frac{V \angle \theta_v}{I \angle \theta_i}$$

which reduces to

$$Z \angle \theta_z = \frac{V}{I} \angle (\theta_v - \theta_i)$$

therefore

$$\theta_z = \theta_v - \theta_i$$

This is an extremely important result. The phase angle of the impedance is a quantity that can be measured directly using an impedance analyzer. Thus, insight can be gained about the relative phase angle of the voltage and current in an audio cable simply by looking at its impedance. Recall that this phase difference quantity appeared in the equations for power presented in the last section.

## Calculating the Power Factor

The power factor is defined as

$$PF = \cos(\theta_v - \theta_i)$$

However, the power factor is usually given as

$$PF = \cos(\theta) \text{ [unitless]}$$

where  $\theta$ , the phase difference between the voltage and current, is known as the power factor angle.

Since we can measure the impedance phase angle of cable, we can calculate the power factor of audio cable by simply taking the cosine of our measurement. We can then use the power factor as a tool to characterize how efficiently an audio cable is functioning as a coupling network.

### A Word of Caution About Power Factors and the Like

While the power factor is an excellent way of "grading" audio cables by efficiency of power transfer, it is not the only criterion. The complete role of a coupling network, such as an audio cable, is very complicated, and no single measurement or criterion will completely specify how well an audio cable satisfies that role. To fully analyze an audio cable, several measurements must be combined. These include, but are not limited to: the gain/phase transfer function, impedance transfer function, time-domain impulse and unit-step response testing, and circuit modeling based on all of the above. Furthermore, if required, other behavior can also be analyzed to specifically focus attention in a desired area. However, the measurements listed above are sufficient to reveal the majority of the information required. These measurements and other topics will be considered for other papers.

### The Power Factor of Audio Cable Energy Storage Elements

#### Ideal Capacitors:

An ideal capacitor has a phase angle of  $-90^\circ$ . Therefore, the power factor (PF) is:

$$PF = \cos(-90) = 0$$

Since an ideal capacitor dissipates no energy (active power), a power factor of 0 indicates a lossless device, and that all the applied power (apparent power) is stored as reactive power within the element.

#### Ideal Inductors:

An ideal inductor has a phase angle of  $+90^\circ$ , and therefore the power factor is:

$$PF = \cos(-75) = 0.259$$

Again, as with the ideal capacitor, the ideal inductor is shown to be a lossless element it stores all of the apparent power as reactive power.

#### Non-Ideal Capacitor:

Suppose, however, that a capacitor has a measured phase angle. The power factor then becomes:

$$PF = \cos(-75) = 0.259$$

Since the cosine function always varies between 0.0 and 1.0, the power factor can be used as an efficiency-scaling factor. In power engineering, the sign of the power factor is disregarded, since it is ambiguous. Recall that the cosine is an even function, so  $\cos(90) = \cos(-90) = 0$ . Therefore no distinction can be made from the power factor alone whether an element is capacitive or reactive.

### Non-Ideal Inductor:

A non-ideal inductor might have a phase angle of 35°. This results in a power factor of:

$$PF = \cos(35) = 0.819$$

A power factor of 0.819 indicates that the inductor is returning only 18.1% of the energy stored in its magnetic flux back to the network in phase. This does not mean, however, the inductor is dissipating the difference (81.9%) in energy as heat. The power factor tells us only what percentage of the apparent power is being returned back to the network in phase with the input as active power. This represents usable power to the load. The power factor does not indicate whether the remainder of the apparent power is being dissipated within the element, reflected back to the source, or released back to the network out of phase.

### The Power Factor of an Audio Cable Model: Ideal Model

In general, MIT views audio cable as a series inductor in parallel with a capacitor, as shown in Fig. 7-1 An ideal circuit cable model would then be the circuit of Figure 7-2.

To examine the power factor of this model, let's assume the inductor has a value of 1mH, the capacitor has a value of 100pF, and the input frequency is 100Hz.

The inductive reactance ( $X_L$ ) is found from:

$$X_L = 2\pi fL = 2\pi(100)(0.001) = 0.628\Omega$$

The capacitive phasor is then:

$$\vec{Z}_C = 15.9k\Omega \angle -90^\circ$$

Next, the equivalent impedance ( $Z_{eq}$ ) can be found. The parallel impedance of a two-element circuit can be obtained from:

$$\vec{Z}_{eq} = \frac{(Z_C)(Z_L)}{(Z_C + Z_L)}$$

which yields:

$$\vec{Z}_{eq} = 0.628\Omega \angle 90^\circ$$

The power factor of this network is then:

$$PF = \cos(\angle Z_{eq}) = \cos(90) = 0$$

This is a very important result. It means that an ideal audio cable would have a power factor of 0. This implies that an ideal audio cable stores all (100%) of the apparent power in the reactive elements as reactive power, and then returns the reactive power back to the network as in-phase active power to be consumed by the load. The 0 power factor also implies that an ideal audio cable does not dissipate any energy within its own network (it has no resistance).

### Non-Ideal Model:

The non-ideal, or non-linear, model takes into account the parasitics of the real-world audio cable. For the purposes of this paper, we will use the non-linear circuit symbols rather than specifying each parasitic's measured value. The non-ideal audio cable circuit model then becomes the circuit of Figure 7-3.

The values of the non-linear components are the actual measured phasor values of the cable. To repeat an important point: Since musical energy is AC, not DC energy, MIT measures the complex impedance (magnitude and phase angle) of audio cable over the entire audio frequency range in order to characterize its performance in the audio environment. Measured at 100Hz, typical impedance values of audio cable might be:

$$\vec{Z}_c = 50k\Omega \angle -89.5^\circ$$

and

$$\vec{Z}_l = 0.001\Omega \angle 5.00^\circ$$

Taking the parallel combination as before yields:

$$\vec{Z}_{eq} = 0.001\Omega \angle 5.00^\circ$$

Notice how the equivalent impedance of audio cable is influenced mainly by the inductive component. The power factor of our practical example is then:

$$PF = \cos(5.00) = 0.996$$

While this number may seem surprising, this is indeed a very common measure of audio cable at 100 Hz.

As before, this result tells us that 99.6% of the apparent power at 100 Hz is not being returned to the network as in phase active power to be transported to the load. Conversely, 0.4% is being transported as useful in-phase active power to the load. As can be seen, audio cables typically have problems transporting active power at these low audio frequencies.

Let's look, however, at a typical cable at 20 kHz:

$$\vec{Z}_c = 20.93k\Omega \angle -85.40^\circ$$

$$\vec{Z}_l = 1.05\Omega \angle 82.20^\circ$$

$$\vec{Z}_{eq} = 1.05\Omega \angle 82.199^\circ$$

for a power factor of:

$$PF = \cos(82.199) = 0.136$$

The high audio frequency power characteristics of this typical cable are much better than its low audio frequency characteristics.



## 8. Test and Measurement Results

### How Tests Reveal the Characteristics of Audio Cables

Earlier, in the section on energy storage elements, we showed how capacitive and inductive reactances of ideal components change with frequency. But what about the phase angles of the elements (L and C), do they change with frequency?

Many articles have been written about modeling audio cable using the discrete components L, C, and R. But all have one major pitfall, they assume that the impedance phase angles of these components are ideal and therefore stay constant over the audio frequency range. This is not the case. Our measurements will show that the inductive and capacitive phase angles of an audio cable actually change with frequency, particularly below about 1 kHz. This has a major implication: **If the impedance phase angle changes with frequency, then the power factor changes with frequency. This means that the cable's power-handling characteristics are frequency dependent.** Furthermore, the total composition of power (the ratio of active power to apparent power, and the mix of active and reactive power) is also frequency dependent.

### Measurement Set-Up

To measure the impedance phase angles, we used a Hewlett-Packard 4284A Precision LCR analyzer. Under computer control, measurements were taken from 20 Hz to 20 kHz, with resolutions as high as 2000 points. The oscillator output level was set to 1 volt. From these measurements, the power factor was calculated and plotted.

A test and measurement note: Measuring a multi-gauge audio cable is more complicated than measuring a zip-cord-type cable. In a multi-gauge cable, each gauge conductor must be measured separately and the data re-assembled mathematically. This process is beyond the scope of this paper and will be considered as a separate paper in the future.

### Measurement Results

Measurement results for four different audio cables are presented in Graphs 1 and 2; a fifth ideal cable has been added to show an ideal response for comparison. The four test cables are:

- A. MIT REFERENCE SPEAKER CABLE
- B. Popular Zip-Cord Type Cable
- C. High End Multi-Gauge Cable
- D. High End Braided Coaxial Cable
- E. Ideal Cable

Graph 1:

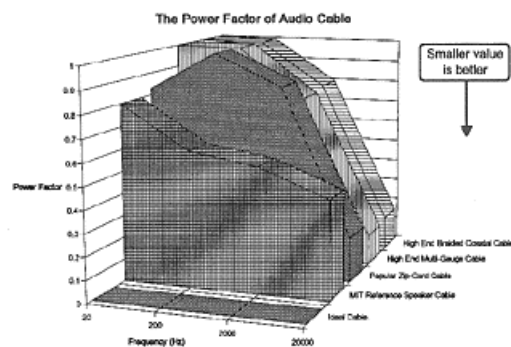

Graph 1 shows the power factor of the test cables versus frequency. The power factor was computed from measured impedance data. The plot clearly shows that below 2000Hz, our own reference cable is the only one here to effectively store and then transport low-frequency energy, as shown by the lowest power factor.

This is because our reference cable is the only one providing proper inductive qualities at low audio frequencies.

Furthermore, the reference cable shows the most linear power factor when plotted versus frequency. This is the result of our design criterion aimed at constantly holding proper inductive qualities not only at low frequencies, but throughout the audio range. Linear inductive phase angles lead to linear impedance phase angles, which result in linear power factor response.

Because the reference cable's power factor does not vary as widely versus frequency as the other cables, the result is a more linear transportation of in-phase active power to the load.

Graph 2.

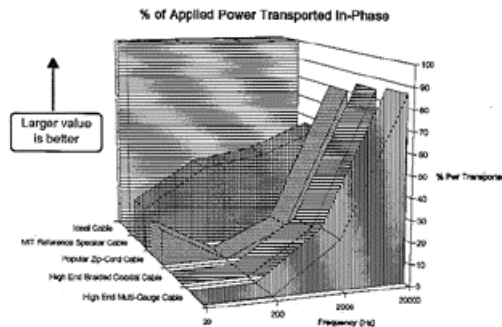

Graph 2 shows a different way of interpreting the power factor. This graph shows what percent of the applied power at a specific frequency is being transported by the cable to the load as active (in-phase) power.

The percent of applied power transported is calculated from

$$\% \text{ Power Transported} = 100 \times (1 - \text{PF}) \text{ [\%]}$$

This is an important graph, because it shows the relative effects of audio cable on the system. The ideal cable plot shows that it does not emphasize or de-emphasize any frequency; it transports power in a perfectly ideal and linear fashion throughout the audio spectrum. The plots for the multi-gauge, coaxial, and zip-cord cables show that, relatively speaking, they de-emphasize low-frequency energy, while high-frequency energy is over-emphasized.

The plot for the MIT cable, while not perfect, shows the most linear power response of the group. No part of the spectrum is emphasized or de-emphasized as greatly as in the other cables.

### Conclusions from Test Results

The test results demonstrate the effectiveness of a design that begins to overcome such engineering problems as the power factor at low frequencies. The networks within MIT's reference speaker cable provide individual inductive pathways allowing for more efficient transportation of musical energy at all audio frequencies. These test results clearly show the role these networks play in transporting active power to the load for consumption. MIT is committed to improving the efficiency of power transportation in all of its audio cables in the future.

## Appendix:

A High End audio cable must transport musical energy as efficiently as possible between system components. Derived from measured impedance data, the power factor can be used to quantify how effective an audio cable is in transporting power between components.

Energy is stored in an audio cable in two forms: as an electromagnetic field in an inductor, and as an electrostatic field in the dielectric of a capacitor. Electrical oscillations are produced when there is a periodic transfer of energy between the electromagnetic and electrostatic fields. This phenomenon is the basis for AC signals.

In top-quality audio cable, proper amounts of both capacitance and inductance are present. Improper amounts of capacitance and inductance

In this paper, the terms: cable, audio cable, network, audio network, and coupling network are used synonymously.

The AC impedance of a cable is determined not only from its resistive elements but also its reactive elements.

Bad phase characteristics cause signal and power distortions.

In this paper, when we speak of power being transported by an audio cable, we are speaking of active power a specific type of power that will be defined later.

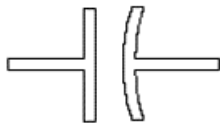

Figure 2-1. Circuit symbol for an ideal (loss-less) capacitor. An ideal capacitor is linear and time invariant.

Capacitance and inductance affect a network's ability to transport power. This happens because an audio signal is an AC signal composed of fluctuating voltages and currents. Inside a cable, changing voltages cause an electric field, and changing currents cause a magnetic field. In this chapter, we will see that the capacitance in a cable interacts with the electric field, and the inductance in a cable interacts with the magnetic field. How the network's capacitance and inductance affect its voltage and current, respectively, determines in large part how power is transported by the cable.

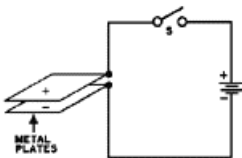

Figure 2-2. Parallel plate capacitor connected to battery.

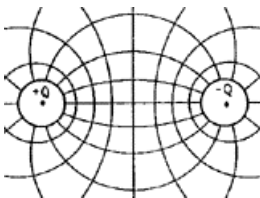

Figure 2-3. Electric field lines created by the separation of charges +Q and -Q.

Electrostatic energy is stored within an audio cable in its shunt capacitance. At low frequencies, even though no current is flowing through the shunt capacitance in an ideal cable energy is still being stored because of the potential difference between the conductors.



Figure 2-4. Non-linear capacitor circuit symbol.

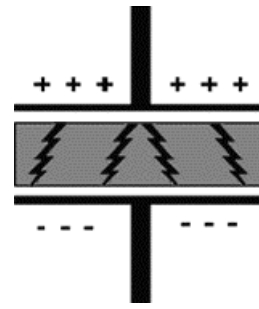

Figure 2-5. An ideal dielectric stores energy and does not dissipate it.

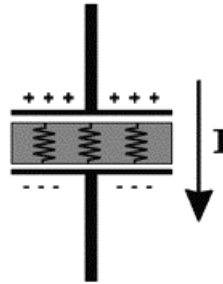

Figure 2-6. A real-world dielectric allows a small amount of current to leak between the plates, causing some power loss.



Figure 2-7. Circuit symbol for an ideal (loss-less) inductor. An ideal inductor is linear and time-invariant.

The energy between the plates of a capacitor is stored in the dielectric.

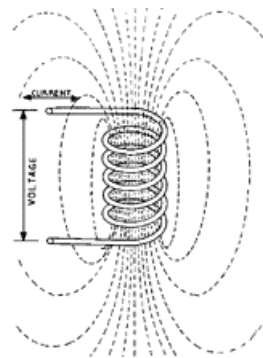

Figure 2-8. Magnetic field produced by an inductor, showing current being stored within the field .

A coil becomes an inductor through a property called self-inductance. Inductors resist changes in current through inductance. By resisting voltage changes, an inductor attempts to maintain a constant current through itself.

As we will see later, a requirement for top-quality audio cable is the proper amount of inductance. Without inductance, an audio cable will not be able to efficiently transport power. This is because of the shunt capacitance present in all audio cables.

The geometry of the cable windings determine its self-inductive properties. Therefore, a single strand of wire can produce different amounts of inductance simply by being wound differently.



Figure 2-9. Non-linear inductor symbol.

The equation for inductance shows that it is current sensitive. That is, an inductor behaves differently for varying levels of current .  
Constructing a cable with many coils of wire is like winding an inductor.

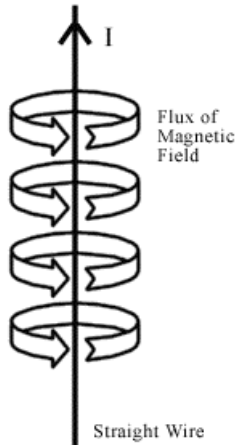

Figure 2-10. Magnetic field lines around a straight wire. The flux lines of the stored current do not cut the wire, showing a low value of self-inductance, and correspondingly low density of current being stored.

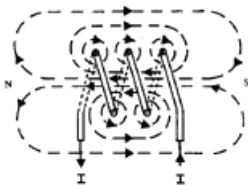

Figure 2-11. A close-up of the magnetic flux in an inductor showing interaction of neighboring coils.

The many coils of wire create numerous flux lines that link together, thereby creating a higher-density current field than that of the straight wire of Figure 2-10. A coiled wire therefore has better self-inductive properties (and stores more current) than a straight wire. As related to audio cables, then, better inductive qualities mean better power characteristics. Thus a coiled wire will transport power more efficiently than a straight wire.

Impedance is the total opposition, offered by resistance and reactance, to an AC signal.

Since audio cables carry musical signals, which are AC signals, audio cables must be characterized using AC mathematics. Furthermore, AC impedance cannot be measured with the same type of instrumentation used to measure DC. A DC Ohm meter cannot be used to find the power factor of audio cable.

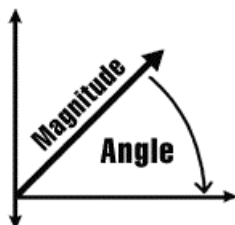

Figure 3-1. Impedance is a vector, with an angle as well as a magnitude. The angle is used in the calculation of the power factor.

The impedance phase angle measurement of audio cable yields important information. The power factor analyzed in this paper is calculated using the impedance phase angle.

Virtually everything you want to know about a network, including power, frequency-domain analysis, and time-domain analysis, can be computed from the network's impedance.

An ideal capacitor has an impedance phase angle of  $-90^\circ$  that does not change with frequency or applied voltage. If it does, the power factor will suffer.

When referenced to time, the voltage across a capacitor lags behind the current.

Capacitive reactance, as with resistance, is given in units of  $\Omega$ . However, unlike a pure resistor, the value of capacitive reactance changes with frequency.

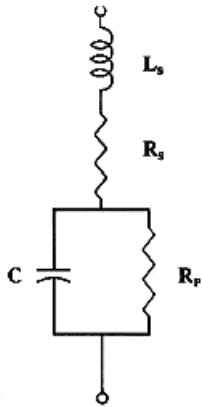

Figure 4-1. Equivalent circuit for a practical capacitor.  $L_s$ ,  $R_s$ , and  $R_p$  are parasitic components, and represent the parasitic losses for a practical capacitor. Parasitics are unwanted adjuncts of wanted circuit elements. When a component's electrical behavior deviates from the ideal, parasitics are used to model the observed losses. The values of these parasitics can change drastically with frequency.

In this paper, we show that parasitics, along with poor self-inductive qualities, are the underlying cause of the poor power factor seen in most audio cables at low audio frequencies. Parasitics bring about a loss of impedance phase angle in audio cables, resulting in less-than-ideal power transfer characteristics.

Ideal inductors have an impedance phase angle of  $+90^\circ$ , which remains constant with frequency and applied current. As with capacitors, if the phase angle varies from the ideal, the power factor will also vary.

The current through an inductor lags behind the voltage across it in time.

Inductive reactance also has units of  $\Omega$ . Unlike a pure resistor, the inductive reactance value changes with frequency.

Parasitic capacitance occurs between the coils of inductors. Parasitic capacitance is a major cause of power-factor loss in audio cable.

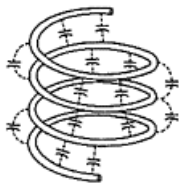

Figure 5-1. Parasitic capacitance between the windings of an inductor. This phenomenon is known as parallel (or mutual) capacitance and denoted CP

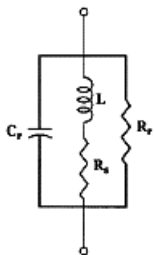

Figure 5-2. Equivalent circuit of a practical inductor.  $C_p$ ,  $R_p$ , and  $R_s$  represent the parasitic losses. The effect of these parasitics, especially  $C_p$ , becomes very dramatic at low frequencies.

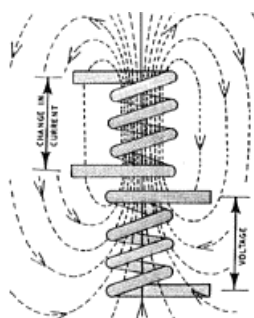

Figure 5-3. AC signals need not pass through a continuous or solid network. This figure shows how the magnetic flux lines link up to pass AC signals when the network is not directly connected. This is the principle behind a simple transformer.

Poor self-inductive properties, due primarily to improper winding of the cable, and parasitic capacitance are the main culprits responsible for the loss of inductive phase angle in audio cable at low audio frequencies. This loss of phase angle causes a higher (worse) power factor.

Rather than relying on self-inductance alone to create the inductance in an audio cable, MIT utilizes mutual inductance, also. By adding mutual inductance, better phase-angle characteristics can be maintained at lower frequencies, leading to a more constant power response through the audio spectrum.

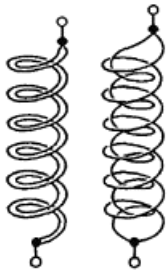

Figure 5-4. Two networks constructed with coils wound differently.

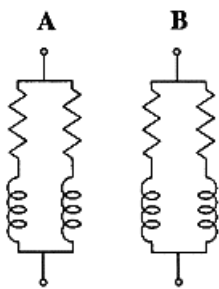

Figure 5-5. Network A shows two parallel inductors resulting in a positive value of  $M$ , or mutual inductance. Network B shows two parallel inductors resulting in a negative value of  $M$ . Network A depicts a desirable winding configuration of properly constructed audio cable.

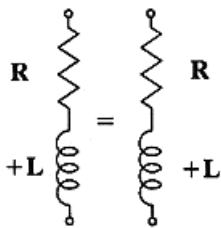

Figure 5-6. Network A reduces to a series inductor and resistor, leading to a desirable power factor.

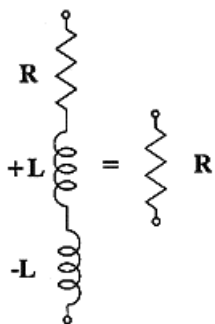

Figure 5-7. Network B reduces to a network consisting of two series inductors and a series resistor.

The series inductors cancel out, leaving the equivalent circuit for Network B as a series resistor only. For a typical audio cable measured on a conventional DC-Ohmmeter, this resistor would have a value of but a few tenths of an  $\Omega$ . But because of the shunt capacitance that is present in all audio cables, this combination will result in a poor power factor.

Since music is composed of AC signals, DC mathematics is not applicable in calculating AC power.

Power is the time rate of energy absorption.

As related to audio cables, apparent power is that power supplied by the source to the cable.

Instantaneous power is calculated by multiplying the values of voltage and current at each point in time.

Note how the formulas for voltage and current have the respective phase angles in them. This is because they are AC signals. Therefore, when the voltage and current are multiplied together to calculate instantaneous power, the phase angles must be factored in.

On the instantaneous power plot, values of power that are above the zero line indicate power that is being absorbed by the network, and values that fall below the zero line represent power that the network is supplying back to itself. To calculate the power consumed over a period, the area underneath the power curve is determined using calculus. As we will see next, this is known as the active power.

As related to audio cables, the instantaneous power plot can be used to determine a network's efficiency in transporting power.

An energy storage element absorbing power is analogous to a sponge absorbing water.

Active power is the time average of the instantaneous power taken over one period. In other words, average power is the area of the instantaneous power plot taken about the zero line. Average power is usually simply known as the power. The final result of the active power calculation is a single, scalar number—it cannot be plotted versus time.

Pure or ideal reactive components, such as capacitors and inductors, return all of the energy they absorb back to the network. Resistors, on the other hand, dissipate all of the energy they absorb as heat.

Pure capacitors and inductors only temporarily store energy, then "squirt" it back into the network as power.

Because active power depends on the phase-angle difference between the voltage and current, the value of active power can change even if the magnitudes of voltage and current stay the same. This is unlike the case of DC power, where there is no phase angle to contend with.

Active power depends not only on the magnitudes of voltage and current, but also on the relative phase angle of the voltage and current in the network.

The familiar units of watts signifies active power is the type of power we should be interested in, since it will be consumed by the load.

Reactive power is non-consumable power. This is the power that is absorbed. The audio signal that is input to the cable is stored as reactive power within the reactive elements (energy storage elements) temporarily. The energy storage elements then release the reactive power back to the network, generating consumable active power.

The more pure and ideal the capacitive and inductive elements of the cable are, the more efficiently the cable will store and release reactive power.

Notice how the capacitor returns all of the power it has absorbed. If this capacitor is part of a network, such as an audio cable, then the power it returns would flow back into the network.

Notice how the resistor dissipates all of the power input to it, rather than returning the power back to the network as does an ideal capacitor or inductor.

How efficiently the capacitive and inductive components of a cable absorb and return power is a critical factor in the cable's performance within an audio system.

Ohm's Law states that the phase difference between the voltage and current is equal to the phase angle of the impedance. The impedance phase angle can be measured and used to calculate the power factor.

Using the power factor, one can determine the ability of any passive coupling network to transport power.

Cables that are properly wound have better self and mutual inductive properties and therefore will have better power-factor characteristics.

The power factor is but one of many criteria that need to be used together to fully characterize an audio cable's performance.

The power factor is calculated by taking the cosine of the power factor angle.

An ideal capacitor has a power factor of zero. This indicates that all the applied (apparent) power is stored within the capacitor as reactive power. Compare with an ideal resistor, which has an impedance phase angle of  $0^\circ$ . The power factor of a resistor would then be:  $PF = \cos(0) = 1$ , indicating that the resistor dissipates all of the power input to it.

An ideal inductor has a power factor of zero. Like the ideal capacitor, all the applied (apparent) power is stored within the inductor as reactive power.



The power factor is an important step in characterizing audio cable, but complete analog behavioral modeling of a cable requires more than the power factor alone.

In a real-world inductor, the phase angle is less than  $90^\circ$ , and the power factor is greater than zero.

In a practical capacitor, the phase angle is less than  $-90^\circ$  ( $-85^\circ$ , for example), and the power factor is greater than zero.

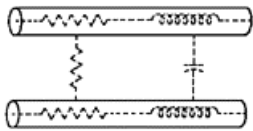

Figure 7-1. The Audio Cable Network: The two conductors of the cable form the plates of a capacitor, while the windings of the conductors form inductors.

The power factor gives the ratio of active power to apparent power. In other words, the power factor is the ratio of power consumed by the network to the input power.

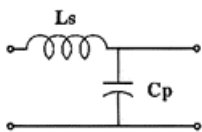

Figure 7-2. Ideal model of an audio cable, using discrete components.

The power factor of the ideal model of audio cable is zero. This means that the ideal audio cable stores applied power as reactive power to be released as active power back to the network. An ideal situation, then, would have an ideal audio cable with a power factor of 0 connected to an ideal load which has a power factor of 1. This way, we can assume that that all of the music has been transported to the load and consumed!

Note the ideal phase angles of  $-90^\circ$  for  $Z_C$  and  $90^\circ$  for  $Z_L$ .

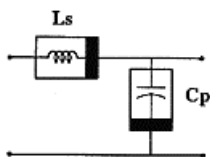

Figure 7-3. Non-linear model of audio cable.

Note that the phase angle of the capacitive component is very nearly ideal ( $-89.5^\circ$ ), while the inductive component is extremely poor ( $+5.00^\circ$ ). These are fairly common measured values for most audio cables when measured at 100 Hz or less.

A power factor of 0.996 is very poor for an audio cable.

Note how the inductive phase angle has increased dramatically at 20 kHz. The power factor then shows the corresponding improvement. A cable with a good (lower) power factor is transporting most of its power as in-phase power.

Most audio cables have very poor power factors at low audio frequencies. This is mainly due to poor inductive phase-angle properties at low frequencies.

Past articles written about audio cables often neglect the fact that the impedance phase angles can change with frequency.

MIT's measurements show that an audio cable's impedance phase angle changes with frequency. Because of this, the power factor also changes with frequency. In short, MIT has shown that the power-transfer characteristics of audio cable are frequency dependent. Having discovered this, MIT designs cables to produce a more linear power-factor characteristic through the audio frequency spectrum.

Proper analog modeling techniques require that many measurements be taken across a wide range of frequencies. However, the process is not as easy for multi-gauge cable. Because each of the separate gauges has its own unique self-inductive signature, each gauge must be measured separately and the data combined mathematically.

The particular test cables used in our tests were chosen by the following criteria: The popular zip-cord type cable is one that is sold world-wide and is often the consumer's first purchase when beginning the path of upgrading his or her audio system. The multi-gauge and braided cables are popular High End cables and recommended by many High-End reviewers.

Graph 1 shows that, below 2000 Hz, the MIT reference speaker cable has the lowest power factor. This means that it is transporting musical energy in this frequency range the most efficiently.

Graph 1 also shows that, while the other cables' power factor changes dramatically with frequency, the MIT cable comes closest to having a power factor that is constant with frequency closest to the ideal cable. This results in a more linear system response, because musical energy of all frequencies is transported through the cable more equally.

No cable is ideal, so a cable can never have a power factor of zero. The goal, then, is to not only have the power factor as low as possible, but also to have the power factor be as linear to frequency as possible.

Graph 2 shows how much active power versus frequency the cable is transporting. The goal is to have the cable transport the same percentage of active power at all frequencies. If this does not happen, then the cable will emphasize those frequencies that it transports power well in, and de-emphasize those parts of the spectrum that it does not transport power in.

Power that is not transported in phase may still be transported to the load. But it will be out-of-phase power.

The result of a design using the power factor to assess a cable's ability to transport power is apparent in Graph 2. While not perfect, the MIT reference cable comes closest to the ideal cable. MIT is committed to improving this ability in its own products in the future.

Through the use of the power factor, we at MIT have been led to conclude that a poor power factor is a mechanism for distortion. That is, that networks exhibiting poor power factor transport and play in-phase music along with out-of-phase music simultaneously. What level of this distortion is audible? We are continuing our research in this area.

# OCOS

## Der Klang

Jegliche Nervosität, Härte oder gar Schärfe gehören mit OCOS der Vergangenheit an, es verbindet perfekte Auflösung auch kleinster Details mit völliger Ausgewogenheit des Klangbilds.

## Die Technik

Die Güte eines Lautsprecherkabels hängt nachweislich nicht von der Anzahl der verwendeten Edelmetalle oder der philosophischen Überzeugung des Herstellers ab!

Sondern von dem aus der Hochfrequenztechnik bekannten Phänomen des Wellenwiderstands im Kabel. Liegt dieser nicht im Bereich des Lautsprecherwiderstandes kann es zu Fehlanpassungen kommen, die den Klang beeinträchtigen.

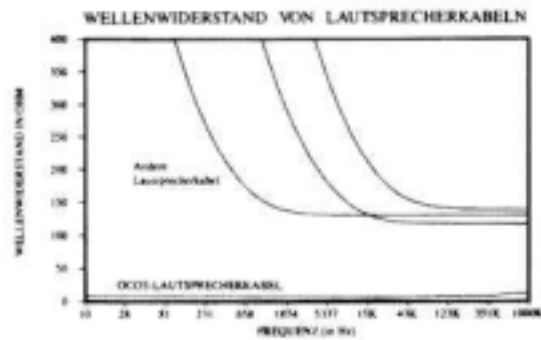

# Goertz

## Alpha-Core/Goertz Audiophile Cabling

Simply a better way from point A to B.



Top to Bottom:  
AG 1 with Spades  
MI 1 with Bananas  
MI 2 with Spades  
MI 3 with Spades  
AG 1 with Hole Punched  
AG 2 with Bananas  
AG 3 with Spades  
Sapphire XLR  
Sapphire RCA  
Triode Quartz RCA

In the ideal world, the signal appearing at the terminals on your loudspeakers would be identical to the signal that left your amplifier. Anything else is distortion, defined as "falsified reproduction", something that is the very opposite of the concept of high fidelity.

Yet while the signal that leaves your amplifier may be as distortion-free as modern electronics technology allows, the signal arriving at your loudspeakers is often thirty years obsolete. Because to reach your speakers, that signal must pass through a distortion-inducing conduit represented by your old-fashioned speaker wire. This sad fact makes decades of amplifier and loudspeaker evolution irrelevant. Simply put, if you connect your components through conventional speaker wire, you'll never hear the sound quality you paid for.

An entire high-end cable industry has sprung up out of the frustrations of audiophiles (and videophiles) trying to properly match their components. But without a scientific foundation these products are little more than overindulgence in styling; "voodoo audio" that often looks better than it works. With the idea that audio design has more to gain from science and engineering than from folklore and tweaking, Alpha-Core has pursued a technology solution. It is the Goertz MI cable system, made possible by combining a patented design with our resources and experience in high-tech laminates for the electronics component industry. For the first time there is a measurable standard in wire.

**Alpha-Core's Serpents**, Goertz with a twist! Electrically and sonically equivalent to Goertz speaker cables, but more robust and better noise rejection...

### Goertz MI Speaker Cables

High purity copper and silver, flat, solid conductors. The patented Goertz design virtually eliminates high frequency roll-off, skin effect below 50 kHz, hum from power wiring and crosstalk. The lowest inductance in the business.

### Goertz Interconnects

Two 18 gauge flat solid conductors sandwiched together. Unprecedented clarity of treble and mid-range, these interconnects provide a near match of cable characteristic impedance with the impedance at the signal source. Offered in RCA and XLR balanced versions. Virtually distortion free.

### The Lowest Inductance In The Business



Introduced in 1994 Alpha-Core's GOERTZ loudspeaker cables have won international acclaim for virtually eliminating distortion even in the longest runs. GOERTZ cables are flat and may be placed under carpets or behind baseboards if desired. Since the flat architecture is not always required we are now introducing a selection of sturdy cables based on the patented GOERTZ technology but with important added features.

The new flat conductor cables are round in cross section and named the Serpents due to their shape and shimmering, speckled pattern. Please note that the Serpents are here to supplement, not replace the GOERTZ cables.



Python MI2, the first Serpent, is electrically and sonically equivalent with our most popular GOERTZ MI2. It contains four film insulated flat, solid OFC copper conductors sandwiched intimately on top of one another and then twisted and embedded in a cylindrical, solid jacket of high grade polymer. The resin is cast in place to totally support and protect the flat conductor bundle, meaning that Python can take any amount of punishment and still sound and look like new.

The newcomers are true low inductance cables just like our original GOERTZ brand, but the twist enhances noise rejection even further to effectively prevent RF and EM interference from entering the feed-back loop. Python MI2 may be terminated either for 10 gauge single wiring or 13 gauge bi-wiring.

When ordered for bi-wiring we recommend Rhodium Banana plugs rather than spades at the speaker end because the flat conductors with spades may prove awkward in case of a tight binding post pattern.

The second Serpent to hit the market, the Boa MI3 will co-exist with our big boy GOERTZ MI3. Boa MI3 may be configured for either 7 gauge single wiring or 10 gauge bi-wiring.

Just like the GOERTZ cables, besides the OFC copper the Serpents are available in solid fine silver designated Python AG and Boa AG. To this selection we have added Python and Boa hybrids featuring two outside solid fine silver conductors and two inside, similarly dimensioned, copper conductors. The jury is still out on the Hybrids but initial auditioning indicates that paralleled for single wiring they provide the silver sonics without glare and excessive brightness, while configured for bi-wiring with silver for the highs and mid-range and copper for the lows, they offer an excellent, cost effective alternative to all silver cables.

The Serpents are available factory terminated with solid silver spades or Rhodium plated spades, banana plugs, or pin connectors. They can also be supplied in bulk for self termination.

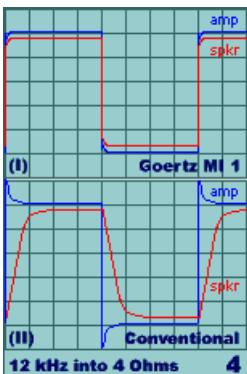

The Proof: Oscilloscope readings comparing the performance of a Goertz cable with conventional designs.

Figure 4 illustrates comparative measurements using a 12 kHz square wave transmitted via (I) a 25 foot Goertz cable, and (II) a 25 foot speaker cable of conventional bi-wire construction, both driving a 4 Ω loudspeaker. The characteristic impedance of the two cables are (I) 4 Ω and (II) 100 Ω. (A) is the signal at the amplifier, and (S) is the signal at the speaker.

Time Base = 10 μS  
 Channel 1 V/DIV = 0.5 V  
 Channel 2 V/DIV = 0.5 V

It is evident that (I) is entirely distortion free, showing only the unavoidable power loss due to cable resistance. (II) in contrast indicates a clear leading edge spike at the amplifier, and significant distortion or roll off at the speaker terminals.

**SERPENTS Specifications** (\*-cross Section for each conductor)

Type	Conductors / Cross Section	Equivalent Gauge / Resistance	Dielectric Material / Outside Dimensions
Python M2	4 OFC Copper / *0.31x0.012"(7.87x0.3 mm)	10AWG / 2 mΩ/ft	Polyester Terephthalate / 0.44" (11 mm)
Python AG2	4 99.99% Silver / *0.31x0.012"(7.87x0.3 mm)	10AWG / 2.2 mΩ/ft	Polyester Terephthalate / 0.44" (11 mm)
Python Hybrid	2 99.99% Silver +2 OFC Copper / *0.31x0.012"(7.87x0.3 mm)	10AWG / 2.2 mΩ/ft	Polyester Terephthalate / 0.44" (11 mm)
Boa MI 3	4 OFC Copper / *0.375x0.02"(9.53x0.5 mm)	7AWG / 1.1 mΩ/ft	Polyester Terephthalate / 0.55" (14 mm)
Boa AG 3	4 99.99% Silver / *0.375x0.02"(9.53x0.5 mm)	7AWG / 1.1 mΩ/ft	Polyester Terephthalate / 0.55" (14 mm)
Boa Hybrid	2 99.99% Silver + 2 OFC Copper / *0.375x0.02"(9.53x0.5 mm)	7AWG / 1.1 mΩ/ft	Polyester Terephthalate / 0.55" (14 mm)

**The Lowest Inductance In The Business**



The patented Goertz MI cable, invented by Ole Goertz, a Danish electronics and audio engineer, eliminates distortion between amplifier and loudspeakers. Patented in 20 countries, Goertz wire is flat by design. It's form follows function, in the best design tradition. We set out to create an electrically correct pathway between amplifier and loudspeaker, which required replacing typical cable pseudo-science with solid physics. Research showed that the perfectly flat shape, with minimum space between conductors, was the best way to achieve this.

But developing such a wire is a different proposition. Many audio companies do not even manufacture their own wire; packaging and marketing the products of others instead. As a primary maker of high-tech laminated conductors for industrial electronics applications, Alpha-Core was uniquely suited to transform the promising Goertz design into reality. Using the dielectrics Polyester Teraphthalate and Teflon applied around each solid rectangular conductor, we achieved an extraordinarily thin profile between the two stacked wires. To provide maximum protection while maintaining thinness, the cable sandwich is then sheathed in tough, high grade polymer.

The result is a wire with a characteristic impedance that closely matches the impedance of loudspeakers. Alpha-Core's Goertz MI wire presents 2 to 4 Ω characteristic impedance as opposed to the 50 to 200 Ω presented by even the most expensive speaker cables. This correct electrical matching results in improved stereo imaging, better clarity, less high-frequency roll off and better low frequency definition.

**Goertz Improves all Frequency Ranges**

**LOW . . . MIDRANGE . . . HIGH**

The degree of distortion along a loudspeaker cable depends on its resistance (R), inductance (L) and capacitance (C). Resistance is dependent on length and conductor cross section. A low resistance provides superior damping between the amplifier and the speaker diaphragm, governing its ability to convey a true, powerful bass and lower mid-range. A high cable inductance causes loss of signal strength towards the high end of the audible range (roll-off). It also causes frequency dependent phase-shift which disturbs true stereo imaging. The square root of the ratio L/C is termed Characteristic Impedance, and is a quality inherent in a cable, dependent on its geometry and materials, but not dependent on its length.

**Goertz Virtually Eliminates Mismatch**

The characteristic impedance of the Goertz MI cables in the order of 2 to 4 Ω closely matches the impedance of loudspeakers. Almost all other speaker cables have characteristic impedance ranging from 50 to 200 Ω, a mismatch which causes distortion due to signal reflections. Impedance matching primarily improves the clarity of the highs and upper mid-range, but many users have also experienced improvements in the lower mid-range. **The cause seems to be that signal reflections caused by impedance mismatch enter the feedback loop of many amplifiers and disturb their ability to reproduce faithfully even lower frequency signals.**



## Thick on Benefits, Thin as a Penny

The low inductance and characteristic impedance of Goertz cables are due to their flat construction and the nature of their insulation and jacketing material. The configuration places the heavy, solid conductors only 0.003 inches apart. The cables are 0.4 or 0.8 inches wide, and only 0.04 inches thick. As thin as a penny.

### Perfect for Home Theater

Goertz MI speaker cable and interconnects are perfect for home theater applications. Due to the low inductance characteristics, Goertz audio products are ideal for long runs. No more positioning your equipment based on the limitations of your cable system. Dolby Digital home theater design requires full range audio frequencies be sent to rear speakers; Goertz cable allows extreme accuracy at any length. The space ratio, the relationship between conductor cross section, is about 50% in Goertz MI cables versus 5-20% in most other speaker cables. In other words, Goertz cables pack heavy conductor cross sections into an extremely slim package yielding greatly improved highs and mid-range, plus a truly powerful bass. Thanks to the flat construction and extreme compactness, they can be drawn anywhere and routed under thin carpets and wallpaper. If desired, paint with oil or water based paint.

### What makes them Special?

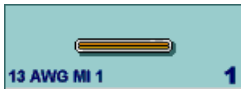

Figure 1 is Goertz MI 1 (MI 2 is almost the same thickness, but twice as wide). Each conductor is a 0.375 by 0.010 inch solid band of high purity oxygen free copper (OFC) surrounded by a 0.0051 inch thick sheath of the space age insulation polyester teraphthalate. The conductors are placed in close mutual contact within a 0.005 inch thick clear jacket. The mutual distance between the conductors is 0.003 inches and the overall dimensions of the cable are approximately 0.4 by 0.040 inches. The space ratio is close to 50%. The conductor cross section approximates 13 AWG, shown approximately twice actual size.



Figure 2 is a section through a competitor's cable extruded from clear PVC, having two stranded conductors of many fine copper wires. The space ratio of this style cable varies between 10% and 20%.



Figure 3 is a so called "multiple bandwidth" or "time compensated" cable with two larger and two smaller conductors twisted together inside a common jacket. The two differently sized conductors are used in parallel. The manufacturer claims that the treble components will travel along the lighter conductor, and the bass frequencies along the heavier conductors. The space ratio is 5% to 10%.



Top to Bottom:  
AG 3 with Silver Spades  
MI 3 with Silver Spades

### Goertz MI 1

The original Goertz cable, MI 1 in 13 gauge (AWG) solid Oxygen Free Copper (OFC) or 12 gauge AG 1 in solid High Purity Silver. The heavy, high purity Oxygen Free Copper (OFC) or solid high purity silver ribbons are sandwiched together, separated only by micro-thin layers of film insulation. The minute amount of active dielectric also provides rapid break-in; now audiophiles don't have to wait tens of hours to break in their cables, Goertz cables produce immediate results!

### Goertz MI 2

MI 2 Heavy 10 gauge OFC copper or 9 gauge AG 2 solid silver cabling for improved bass and power handling over the remarkable Goertz MI 1. Great reviews confirm that this remarkable cable really delivers; superb bass control, vivid mid-range, and excellent high frequency extension combine with rejection of interference and no break-in period. Simply great value.

### Goertz MI 3

Alpha-Core's "Big Boy" 7 gauge speaker cable; the answer for powerful audiophile systems. MI 3 was designed for high power amplifiers driving full range speakers. Perhaps the best speaker cable made today, the MI 3 delivers sublime clarity, dynamics, and definition throughout the audio spectrum. The extreme low DC resistance ensures diaphragm control for tight, powerful bass and mid-range, and the low inductance carries distortion free highs frequencies and crucial harmonics for outstanding imaging and depth perception.

Goertz 7 gauge MI 3 cables were developed at the request of Dan D'Agostino of Krell Industries and other customers who were seeking a speaker cable to complement today's powerful amplifiers. Double the cross section of Goertz MI 2 and AG 2, this newcomer features two solid conductors each measuring 1.25" by 0.012". As in Goertz MI 1 and MI 2, the micro-thin film dielectric means minimum break-in time.

The 7 AWG cable is available in two versions: The MI 3 'Divinity' in OFC copper, and the AG 3 'Divinity' in solid fine silver. Both are supplied with four inch user-friendly pigtails, and both feature Alpha-Core's unique solid fine silver spade connectors to fit all high-end binding posts. Goertz AG 3 is arguably the heaviest solid fine silver cable ever made. An eight foot pair contains more than a pound of 99.99% pure silver.

So, for that extra muscle to drive the really powerful systems, Goertz MI 3 or MI AG 3 is the answer, The Alpha-Core "Big Boys" deliver punch in the bass and a sound so revealing that we maybe ought to mark them "Adults Only".

### GOERTZ MI Specifications

Type	Conductors / Cross Section / Equivalent Gauge	Resistance / Capacitance / Inductance / Impedance	Dielectric Material / Outside Dimensions
<b>Goertz MI 1: 'Center Stage'</b>	High Purity Oxygen Free Copper / .375 x .010" / 13 AWG	0.0044 Ω/ft / 0.5 nF/ft / 10 nH/ft / ~ 4 Ω	Polyester Terephthalate/ Polycarbonate / 0.4 x 0.04"
<b>Goertz MI 2: 'Veracity'</b>	High Purity Oxygen Free Copper / .750 x .010" / 10 AWG	0.0022 Ω/ft / 0.95 nF/ft / 6 nH/ft / ~ 2.5 Ω	Teflon/ Polyester Terephthalate/ Polycarbonate / 0.8 x 0.04"
<b>Goertz MI 3: 'Divinity'</b>	High Purity Oxygen Free Copper / 1.25 x .012" / 7 AWG	0.0011 Ω/ft / 1.5 nF/ft / 4 nH/ft / ~ 1.7 Ω	Teflon/ Polyester Terephthalate/ Polycarbonate / 1.3 x 0.08"
<b>Goertz AG 1: 'Center Stage'</b>	High Purity Solid Fine Silver / .375 x .010" / 12 AWG	0.0034 Ω/ft / 0.5 nF/ft / 10 nH/ft / ~ 4 Ω	Polyester Terephthalate/ Polycarbonate / 0.4 x 0.04"
<b>Goertz AG 2: 'Veracity'</b>	High Purity Solid Fine Silver / .750 x .010" / 9 AWG	0.0017 Ω/ft / 0.95 nF/ft / 6 nH/ft / ~ 2.5 Ω	Teflon/ Polyester Terephthalate/ Polycarbonate / 0.8 x 0.04"
<b>Goertz AG 3: 'Divinity'</b>	High Purity Solid Fine Silver / 1.25 x .012" / 7 AWG	0.00098 Ω/ft / 1.5 nF/ft / 4 nH/ft ~ 1.7 Ω	Teflon/ Polyester Terephthalate/ Polycarbonate / 3 x 0.08"



## Goertz Cables FAQ:

### Physical Characteristics of Loudspeaker Cables.

Today, based on two decades of research and comparative listening, audio engineers agree that the most natural sound is achieved by a combination of low series inductance L and a low loop resistance R. A low L is instrumental in minimizing high end roll off and frequency dependent phase shift, and a low R is important for a true and powerful bass and low mid-range.

A low series inductance L is achieved by placing the two conductors in the cable as close together as physically possible, and in the patented GOERTZ design they are wide bands of solid copper or silver which are sandwiched together, only separated by a micro thin film of a high grade dielectric. This geometry will result in an extremely low L, and a capacitance C much higher than that of conventional cables. The combined effect is to reduce the characteristic impedance of the cables all the way down into the single digits to almost match the nominal impedance of a typical speaker load. The impedance match minimizes distortion caused by ringing and signal reflections and would not be possible without the high relative capacitance. This combination of a low L and R, and a high C value is the secret behind the exceptional performance of GOERTZ loudspeaker cables.

For purpose of comparison R must be measured as loop resistance or the sum of the resistance in both conductors. Some manufacturers incorrectly state the resistance in just one conductor, thus arriving at a figure which is only 50% of the true R.

Type	R Loop-resistance (mΩ/ft)	AWG, app.	L Series inductance (μH/ft)	C Capacitance (pF/ft)	Characteristic impedance (Ω)
van den Hul "Hybrid"	2.1	10	0.28	5.8	220
Cardas Quadlink 5C	4.0	13	0.18	23	89
Lamp Cord	12.8	16	0.16	16	100
Nordost Solar Wind	6.0	14	0.10	7.5	129
Kimber 4 TC	4.3	13	0.07	44	40
Kimber 8 TC	2.1	10	0.03	100	17
Alpha-Core, GOERTZ MI 1	4.3	13	0.01	500	4.5
Alpha-Core, GOERTZ MI 2	2.1	10	0.006	945	2.5
Alpha-Core, GOERTZ MI 3	1.1	7	0.004	1350	1.8

### Which one?

The main parameter setting the SERPENTS/GOERTZ series apart is their DC resistance, also expressed as equivalent AWG or gauge. The gauge you should select is a function of the output power of your system and the length of the run. A wider and heavier cable with a low AWG will serve a more powerful system and longer runs than a lighter cable.

Goertz MI 1 cable equals 13 AWG, Goertz MI 2 10 AWG and MI3 7AWG. The difference of 3 between the gauges indicates that the DC resistance of MI 2 is only half that of MI 1 and that the DC resistance of MI3 is half again of that of MI2. Each step thus means cutting the loss of signal strength in half, but another more important effect is the improved speaker diaphragm damping which translates into a largely undistorted, truly powerful mid-range and bass, even at high power levels and over long runs.

**Goertz MI cables have a characteristic impedance of 2 to 4 Ω , but the rated impedance of my speakers is 8 Ω. Don't I need speaker cables with a characteristic impedance of 8 Ω?**

Most other speaker cables, even sophisticated high-end cables, have a characteristic impedance between 50 and 200 Ω and a correspondingly high inductance resulting in a loss of fidelity due to high frequency roll-off. Besides, the impedance of most speakers is not a fixed parameter but varies according to the signal frequency. A loudspeaker rated at 4 Ω may well have a considerably lower impedances at low frequencies and maybe an impedances of 8 Ω or higher at the high end of the audible range. Experience indicates that a perfect match is neither feasible nor required, and all Goertz MI cables will work well with speakers rated at 2 Ω up through 8 Ω.

## Are GOERTZ cables EMI/RF shielded?

No, they do not incorporate a shield like e.g. the braided wire hose which is often seen surrounding conventionally designed interconnect cables. In general, due to the much stronger signals involved, shielding is not required in speaker cables, but rejection of cross talk and RF interference is a must in an interconnect cable. An open geometry ribbon cable used as an interconnect will function as a loop antenna literally inviting RF interference, whereas the closed GOERTZ geometry exhibits excellent noise rejection in itself. The insensitivity to noise is even further enhanced in the Micro Purl series, where the close sandwich of extremely thin, relatively wide conductors is twisted or "purlled" in the manner of twisted pairs used so widely in telecommunication.

## Obviously, termination of Goertz cables is different from most other loudspeaker cables. Will this cause difficulties for me?

Goertz speaker cables are available pre-terminated in standard lengths from 4 to 20 feet long in 1 foot increments; and in 25, 75 or 150 foot bulk packages which come with directions for termination and installation. They may be terminated by means of the special slotted Goertz terminals which are fitted onto the flat conductors by means of large diameter set screws. Another method which is becoming popular with bi- or tri-wiring is hybrid termination by attaching a short length of conventional stranded wire to each conductor inside an insulating plastic boot. Hybrid terminated cables are mounted just like any other wire directly into the binding posts or with any type of crimp lug. A third choice, often used in automotive systems involves punching a hole in the flat conductors, which are then hooked up to the terminal bars by means of screws and washers. This method is also used by component manufacturers for connections inside speakers and other equipment.

Top to Bottom:



MI 2 with Bananas  
MI 2 with Hybrid Termination  
MI AG 1 with Silver Spades  
MI 1 with T (Auto-style) Termination

The slotted, Rhodium plated GOERTZ terminals are available in three styles: Spade lugs, Banana Plugs and Pin connectors. They come in boxes of four. Two boxes are required for a pair of speaker cables.

In addition to the slotted connectors we offer a heavy, spade connector made of solid, high purity silver. The silver spades are attached to the conductors using silver solder and insulated by means of high quality shrink tubing.

Before termination cables are cut to length, the outer polymer jacket is removed, and the conductors stripped of their insulation by sanding or a sharp instrument. This task is not difficult but can be avoided entirely if cables are ordered already cut-to-length, stripped and termination ready.

## I'm not an electrical engineer, what do these terms really mean?

### Basic stuff:

Even though they are marked with +/-, like a direct current (DC) circuit, speaker cables carry a complex alternating current (AC) signal, which varies in frequency (expressed as Hz, or cycles/second) and amplitude. The perfect speaker cable would have no losses, just like soldering your amp outputs to the back of the speaker drivers. But, in practice, cable has a much more complicated effect on the signal; where interactions between amplifier impedance and power, connector efficiency, conductor efficiency, insulating materials, spacing, speaker impedance and radio interference, can affect the music you hear. The results can be subtle or quite drastic but are usually most similar to filtering and/or delaying certain frequencies. Since an audio signal is composed of hundreds of harmonic frequencies, delaying or filtering some frequencies makes the sound muddy and destroys subtle rhythmic timing information.

The signal problems for interconnect cables are very similar to speaker cables. Interconnects have shorter runs and carry lower power, but the timing and filtering effects are still present, and since the signal may pass through several runs of cable (CD player to pre-amp, pre-amp to power amp, etc.) there may be cumulative losses. Another issue is raised for interconnects, that of electromagnetic interference (EMI/RFI) from the audio components themselves and from other cabling. Since power decreases rapidly with distance from the source, speaker cables may be largely excepted from this problem, but most systems have a number of interconnects running very close together.

### Capacitance

1. The ratio of charge to potential on an electrically charged, isolated conductor.
2. The ratio of the electric charge transferred from one to the other of a pair of conductors to the resulting potential difference between them.

Capacitance is usually thought of as storage of electricity, or potential. If you store up a lot of electricity you can do a lot of work with it if it's accessible, as with the power supply capacitors in your amplifier. To use a water analogy, a ripple on a lake is still a ripple on a lake, regardless of the depth of the water.

### Characteristic Impedance

The degree of distortion along a loudspeaker cable depends on its resistance (R), inductance (L) and capacitance (C). The square root of the ratio  $L/C$  is termed Characteristic Impedance, and is a quality inherent in a cable, dependent on its geometry and materials, but not dependent on its length.

The characteristic impedance of the Goertz MI cables in the order of 2 to 4  $\Omega$  closely matches the impedance of loudspeakers. Almost all other speaker cables have characteristic impedance ranging from 50 to 200  $\Omega$ , a mismatch which causes distortion due to signal reflections. Impedance matching primarily improves the clarity of the highs and upper mid-range, but many users have also experienced improvements in the lower mid-range.

The cause seems to be that signal reflections caused by impedance mismatch enter the feedback loop of many amplifiers and disturb their ability to reproduce faithfully even lower frequency signals.

### Damping

The ability to precisely control the overshooting momentum of a speaker diaphragm, to force the diaphragm to move accurately is called damping, and is rated as amplifier 'Damping Factor'.

Speaker cones are subject to the laws of physics, and especially momentum. The mass of the speaker diaphragms must be continually accelerated to new velocities to match the waveform being presented. As mass increases (as in woofers) the power needs increase, but another effect comes into play as well: the driver often overshoots and the driver coil actually generates an opposing signal (like all electromotive devices) as the amplifier attempts to control the movement. This new signal coming from the speaker coil must be cancelled, or damped, by the amplifier. Better coupling between the amp and speaker via heavier cabling allows the amplifier circuitry to perform damping up to design capacity and make cleaner sound.

### Dielectric

A non-conductor of electricity, especially a substance with electrical conductivity less than a millionth ( $10^{-6}$ ) of an ohm.

It's the insulation on the wire. Oddly, the insulation has an effect on the fields traveling along the conductor despite the fact that it carries no current. This interference with the current is called Dielectric Involvement, and it varies with the material (PVC, Polycarbonate, Polyurethane, Teflon, etc.), the thickness, the length of the cable run, and the proximity to other conductors. In fact, the molecules of the polymers move slightly in reaction to the electromagnetic fields of the conductors (high power fields are even used to heat these materials for some industrial applications). This steals energy from the signal. Over time, the polymer molecules will tend to align in a 'least force' configuration, this accounts for the 'break-in' interval which is widely discussed for cables and audio components.

## **Impedance**

A measure of the total opposition to current flow in an alternating current (AC) circuit, equal to the ratio of the arms of the electromotive force in the circuit to the rms current produced by it, and usually represented in complex notation as  $Z = R + iX$ , where R is the ohmic force and X is the Reactance.

## **Impedance Matching**

The use of electric circuits, transmission lines, and other devices to make the impedance of a load equal to the internal impedance of the source of power, thereby making possible the most efficient transfer of power.

This is the goal of Goertz MI (matched impedance) cable.

## **Inductance**

The generation of electromotive force in a closed circuit by a varying magnetic flux through the circuit. Also called 'electromagnetic induction'.

Usually, this terms is used loosely as an alternative to Impedance, which is the opposition to AC current presented by a circuit. This is actually the force that moves your speaker cones; it also causes cable losses when electromagnetic energy moves conductors around microscopically.

We've all played with magnets, and felt the attracting and repelling forces created. Running an electric current through a wire produces a magnetic field around that wire. As the magnetic field expands and contracts with the amplifier's signal, it will induce a current in any other conductor within its field. If a nearby wire is carrying its own signal, the magnetic fields around the two will cause them to attract or repel. This increases skin effect distortion for multiple strand cables; by alternately pushing or pulling adjacent wires apart and further increasing the contact resistance.

A high cable inductance causes loss of signal strength towards the high end of the audible range (also known as roll-off). It also causes frequency dependent phase-shifting which disturbs true stereo imaging.

## **Microphony**

Noise caused by galvanic interaction between the individual strands in a cable. This type of noise may be eliminated by replacing the stranded conductors with solid bands of metal.

## **Oxygen Free Copper (OFC)**

No metal is absolutely pure, and contamination, as well as the crystalline structure of copper, can have a dramatic effect on signal quality. Impurities within the copper, including oxygen, silver, iron, sulfur, antimony, aluminum and arsenic, coalesce at the grain surface, or boundary. This creates a much higher impedance to the electron flow by essentially forcing the electrons to have to 'jump' those poorly conducting boundaries where grains touch. Reducing the impurity content and the number of grains per foot can make a wire a much more efficient conductor.

Normal high purity (commercially called 'tough pitch') copper has about 1500 crystals or grains in each foot. Current must cross these grain boundaries 1500 times in each foot of cable. These grain boundaries cause the same type of irritating distortion as current crossing from strand to strand from the skin effect.

OFC copper, which is 99.999% pure is still not perfect, but the higher purity reduces the number of grains per foot, and makes the sound audibly smoother.

## **Reactance**

Opposition to the flow of alternating current (AC) caused by inductance and capacitance in the circuit.

Hmmm, kind of like impedance? It's one component of it.

## Resistance

Opposition to direct current (DC) presented by a circuit.

This is determined by the conductor length, the total cross-sectional area, and the conductivity of the cable's metal core. A low resistance provides superior damping factor between the amplifier and the speaker diaphragm, governing its ability to convey a true powerful bass and lower mid-range. Resistance causes equal losses at all frequencies while inductance causes varying degrees of loss in proportion to frequency.

## Ringling

The buildup of vibration due to energy storage and the continued vibration from release of the energy stored in a circuit after the applied energy is removed.

Also called Resonance. In effect, the signal echoes back and forth down the length of the cable, and creates disturbances in the signal waves, like ripples in a pond interfering with each other.

## Skin Effect

Tiny circulating 'eddy' currents in large AWG individual conductors make the apparent inner core resistance increase with frequency so that the 'skin' of the conductor has the least resistance to current flow. Higher frequency signal electrons flowing through the conductor move to the outer surface of that conductor. The higher the frequency, the more pronounced the skin effect becomes.

In a multi-strand wire things get worse, as the skin effect still applies to the geometry of the entire bundle of conductors. Any strand can be found at a different location or depth in relation to the cross-section of the strand bundle as you move along its length. At higher frequencies, the signal is jumping from strand to strand to stay on the outside of the bundle. Unfortunately, the point of contact between strands is actually a simple circuit exhibiting its own capacitance, inductance and diode rectification, presenting a whole host of problems.

## EMI/RFI

Electro-Magnetic Interference / Radio Frequency Interference

We live in an invisible sea of electromagnetic energy, caused by the electronics we own, the radio stations which operate, the earth's movement through space, even the sun's radiations. All these signals, when summed together in your living room, are called EMI/RFI. EMI interference is conducted from other audio components or appliances in your home (a humming refrigerator makes a lot of hash on you AC power lines, too). RFI is radiated by the components and cables themselves, and received from radio signals/noise in the environment (which is much worse in urban areas; all those cell phones, etc.).

It's all noise and has varying affect on audio signals which cannot improve them. Components and cables can be designed to reject RFI noise, and proper filtering of wall current and signal cables can reduce EMI conducted noise, and the results can be heard if you have quality equipment.

## I hear that GOERTZ speaker cables have a high capacitance. How will this affect my system ?

Low impedance, matched speaker cables represent the ideal path from the amplifier to a loudspeaker but in rare cases may cause small percentage of solid state amplifiers to become unstable when combined with certain speakers. The symptom is audible oscillation or overload shutdown. Fortunately the problem is easily solved, by installing an Alpha-Core RC link across the terminals of each speaker. A pair of RC links is provided free of charge with our ultra low impedance GOERTZ and Serpent series cables.

The advantage of the low impedance, matched path is that the amplifier is rendered able to exert control and damping of voice coil resonance, and all frequency bands are transferred with the same interrelated magnitude irrespective of cable length. This also means that the cables to the left and right channels of a stereo system can be of unequal length if desired, largely without ill effects.

The impedance of voice coils in dynamic loudspeakers and their crossover networks rises with frequency, causing a corresponding decrease in audio output at high frequencies.

At low audio frequencies a voice coil behaves almost like a purely resistive load but at for example 20 kHz its impedance may rise to more than 10 times the DC resistance. This is mainly due to self-inductance, which causes the almost purely inductive impedance to rise even further above 20 kHz.

Unfortunately the feedback loop in certain solid state amplifiers does not satisfy the Nyquist or Bode criterion for stability. The amplifier may at times exhibit gain band widths in the internal feedback loop in the megaHertz order, meaning that things may start happening above the audible range. The problem arises when this type of amplifier is connected with loudspeakers that exhibit high impedance at high frequencies, via an otherwise ideal low impedance matched cable. Under certain circumstances, instead of stabilizing the gain via the internal feedback loop as intended for a low impedance output, the amplifier is turned into a HF power oscillator operating at a frequency well above the audible range. This may load the amplifier excessively, resulting in higher than normal operating temperature or overload shutdown.

Our remedy is to place a resistive load across the speaker terminals, which becomes effective at frequencies well above the audible range. Tests have shown that a 0.1 microfarad capacitor in series with a 10  $\Omega$  resistor will do the trick if applied across the speaker terminals. The combination "RC Link" also called a Zobel network, is supplied free of charge by Alpha-Core to be applied when needed.

A simple calculation shows the impedance of the RC link to be 14  $\Omega$  at 159 kHz, amply illustrating that they in no way affect performance at audio frequencies.

Incidentally, the situation described in the above does not occur with electrostatic speakers or with tube amplifiers containing output transformers.

### **What is the difference between Nordost Flatline and GOERTZ?**

They are both flat cables, but the resemblance really stops there. The Nordost geometry with its two groups of conductors arranged side by side in an open pattern will exhibit a medium to high series inductance, and due to the skinnier conductors, also the loop resistance is much higher than that of equally priced GOERTZ cables. It is worth noting that the premium series of Nordost cables utilize silver plated copper conductors whereas GOERTZ's AG series all have solid, high purity silver conductors.

### **Alpha-Core Interconnect Cables**

Unprecedented clarity of treble and high to mid-range, interconnects provide a near match of cable characteristic impedance with the impedance at the signal source. Offered in RCA and XLR balanced versions. Virtually distortion free.

Featuring a similar geometry and high integrity construction that has won Alpha-Core's speaker cables extensive praise from reviewers, consumers, and installers - our interconnects provide demonstrably better component-to-component analog signal transfer in any high quality audio or audio/video system.

The design addresses many problems unique to interconnects. In addition to providing an ideal balance of inductive, resistive, and capacitive characteristics, these interconnects are also impervious to spurious radio-frequency and electromagnetic signals that often corrupt audio information.

### **Unique Flat Design**

Alpha-Core interconnects consist of two or three flat, solid conductors sandwiched on either side of a microscopically thin dielectric. The result, a signal cable with an extremely low inductance and unprecedented clarity of the treble and high midrange. The conductors are bands of solid fine silver or high purity OFC copper. They are finished with transparent jackets of high grade polymer and fitted with Teflon insulated black chrome RCA or XLR balanced connectors with rhodium or gold plated contacts.

The low inductance, an effect of the Alpha-Core's patented geometry, eliminates radiated fields while at the same time rejecting extraneous fields. This means that our interconnect cables can be bundled with other signal and power cables without any risk of cross talk or line frequency hum. Extensive tests have established that they are impervious to broadcast bands and other EMI and RF fields, and thus provide a virtually undisturbed signal path between source components and pre-amplifiers, and between pre-amplifiers and power amplifiers.

### **Matched Impedance Reduces Ringing**

Another reason for the unprecedented clarity reached with the Alpha-Core interconnects is the absence of signal reflections and ringing, attained through a near match of cable impedance with the impedance encountered at the signal source. Because in most cases the output impedance at the source differs vastly from the input impedance at the load side, a match at both ends is impossible. But, as demonstrated with the Goertz MI speaker cables, a single sided near match is sufficient to effectively prevent mismatch signal reflections from traveling back and forth through the signal cables and eventually entering the amplifier feedback loops.

### **'Micro Purl', Copper and Silver**

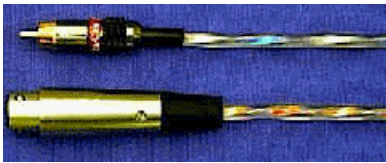

The revolutionary Micro Purl is cutting-edge transmission line technology. It contains two 50  $\mu\text{m}$  thick by 2 mm wide signal carriers made of solid fine silver or OFC Copper, placed on each side of a copper ground plane. The ultra thin three layer sandwich is then twisted (purl) as it is embedded in a heavy sheath of transparent high grade polymer.

The twisting facilitates handling and further enhances EM and RF rejection. Micro Purl is breaking new ground as professional quality microphone and patch cables, and as digital interconnects.

### **TQ 1 'Triode Quartz' Solid Fine Silver**

The 'Triode Quartz' was designed on special request by tube enthusiasts and is one of the most powerful thin interconnects made today. TQ 1 is made of 99.99% pure solid fine silver foil, with each conductor equivalent to 21 gauge wire. The prime effect of placing two relatively wide, thin conductors within only 0.003 of each other is to drive the inductance way down; far below that of any cable based on coaxial geometry. This means a very low characteristic impedance and an almost total elimination of high frequency roll-off.

### **TQ 2 'Triode Quartz' Solid Fine Silver**

Since we introduced the new "Micro Purl" interconnect cables many customers has asked us whether we are planning a new version of our popular TQ1 cable incorporating the same features which have proven so successful in "Micro Purl".

The new TQ 2 is made in similar fashion as Micro Purl, by twisting the bundle of solid fine silver conductors and copper ground plane in line with the extrusion of a tough, crystal clear jacket of high grade polymer. The result may be coiled and handled like any other cable and will take considerable punishment without equivalent to AWG 22, and the overall diameter is .32" versus .25" for Micro Purl. The electrical parameters and sonic characteristics are the same as those of TQ 1 except for the fact that the in-line twist has further improved the EMI and RF noise rejection inherent in the low inductance geometry.

Unfortunately with the new development our manufacturing costs have gone up, necessitating a price increase of 20% effective immediately. TQ1 will remain available at the original price as long as stocks last but will then be discontinued.

### **'Tourmaline' Copper**



Two thin 18 gauge high purity Oxygen Free Copper (OFC) conductors are sandwiched together, separated only by micro-thin layers of film insulation. The minute amount of active dielectric also provides virtually no break-in!

### **'Sapphire' Silver**

Two thin 18 gauge 99.99% pure solid fine silver conductors are sandwiched together in the unique Goertz configuration. Impervious to extraneous line frequency and RF fields, with the great ultra clean sound of solid fine silver.

Type	Conductors / Cross Section / Equivalent Gauge	Termination	Dielectric Material /Outside Dimensions
<b>'Micro Purl' RCA or XLR: Copper</b>	High Purity Oxygen Free Copper / 0.078"x0.010" OFC Central GND Plane / 26 AWG	Black Chrome/Teflon Rhodium Plated RCA or Black Chrome/Teflon Rhodium Plated Balanced XLR	Transparent high grade Polymer
<b>'Micro Purl' RCA or XLR: Silver</b>	High Purity Solid Fine Silver / 0.078"x0.010" OFC Central GND Plane / 26 AWG	Black Chrome/Teflon Gold Plated RCA or Black Chrome/Teflon Rhodium Plated Balanced XLR	Transparent high grade Polymer
<b>TQ 2 'Triode Quartz' RCA or XLR: Silver</b>	High Purity Solid Fine Silver / 0.125 x .005" OFC Central GND Plane / 21 AWG	Black Chrome/Teflon Gold Plated RCA or Black Chrome/Teflon Gold Plated Balanced XLR	Transparent high grade Polymer
<b>'Tourmaline' RCA or XLR:</b>	High Purity Oxygen Free Copper / 0.25 x .005" / 18 AWG	Black Chrome/Teflon Rhodium Plated RCA or Black Chrome/Teflon Gold Plated Balanced XL	Polyester Terephthalate/Polycarbonate / 0.312 x 0.065"
<b>'Sapphire' RCA or XLR:</b>	High Purity Solid Fine Silver / 0.25 x .005" OFC Central GND Plane / 18 AWG	Black Chrome/Teflon Rhodium Plated Balanced XLR	Teflon/ Polyester Terephthalate/ Polycarbonate 0.312 x 0.065"



# TNT-Audio

## The Naked Truth about Speaker-Cables

### Bananas, bananas. More lengths of cable talk we have to do....

Well folks, it has been a while since I have written about Cables. So, if you don't believe in Cables, or if you have bought the latest boutique Wire and want to remain happy with your Purchase, you best stop reading now....

This "naked Truth about Speaker-Cables" could be seen as second installment to "The Naked Truth about Interconnect-Cables". It deals with a few more of the issues around Cables in general and focuses on Speaker-Cables.

The DIY-part will attempt to provide a simple, inexpensive and easy to make Speaker-Cable. It will nevertheless, due to its inherent construction, provide a significant improvement over most commercial Speaker-Cables and if I dare say so myself, even over the TNT-Star DIY Speaker-Cable.

Anyone intending to save the dry theory and just wanting to get stuck in with making cables; you can go ahead and make one out of these two:

A Cable intended to be an all out Assault on the state of the Art, the "UBYTE-2" Cable .

Alternatively you can keep it a bit simpler and more sane. Just make the "FFRC" (Full Frequency Range Cable). This is a Cable intended to be a significant Upgrade over something like the common, moderately expensive, multi-stranded Cable generally employed and sold as "Specialist Speaker-Cable".

### The stark naked and ugly truth

I think first of all it is important to realise that VERY few so called Cable Manufacturers really make their own Wire and Cable. More often the actual wire employed is only a slightly customised version of what any of the large cable and wire making companies like Belden produce.

In more than a few cases I have seen Cables, were the "customisation" actually meant a Jacket in the latest Designer-colour and some fancy print. Some Companies do exist, which do a lot of fundamental research and often make some or all components for their Cable in their own Factories.

The numbers are however VERY few, as such an approach requires a lot of capital to be invested. Other Companies have found by accident or research a certain commercially made cable or wire which worked very well. They strated to market a cable based on this and later managed to have this Wire improved by adjusting it to their Spec.

In many cases I have found that the price cannot be taken as indicator as to how and by whom the Cable you are buying has actually been manufactured. So I think it is fair and true (but very uncomfortable) to say that most specialist "HiFi-Cables" are an exercise in marketing to about 95 % and maybein Research for 5%.

Please remember, not all companies selling specialist HiFi-Cables are guilty of these practices, but many are. Please also note that in my following Article I do mention a number of companies making or selling HiFi-cables.

Their inclusion does not constitute as such an endorsement of their products or indeed a statement to the contrary. It is simply that their products are well known and often are typical for a specific design-technique mentioned.

### Cables - are they different?

So what makes the average High-End Cable tick and what can be considered as "universally" good?

I divide audible effects affecting the performance of the Cable into three Orders. They are the First, Second and Third in order of Importance and sonic impact. See " The Naked Truth about Interconnect-Cables" for a more detailed description of these orders of effects.

It should be noted that depending on external and interface conditions second order effects and first order effects can sometimes change places in terms of magnitude....

I would propose, that the usual RLC parameters (as with Resistance [R] , Inductance [L] and Capacitance [C] ) should be viewed as first order effects, though not in all situations each parameter carries the same weighting.

Let's have an example for the different weighting in RLC Parameters, due to the relevant source and load impedance's. In Interconnects the source-impedance is between a few  $\Omega$  and a few  $k\Omega$  and load impedance between 10  $k\Omega$  and about 1  $M\Omega$  (both usually mostly resistive).

As a result the Capacitance (C) is a prevalent characteristic with Resistance (R) and Inductance (L) relegated usually BELOW most second Order Effects in their magnitude of sonic impact.

A second order effect, the Dielectric Absorption (DA) becomes here a first order effect in audible magnitude. So the main parameters for Interconnects are C and DA as long as R and L are kept in sane regions (see "The naked Truth about Interconnects").

The Skin effect remains relevant (but firmly in the second Order Camp) as does the Maxwell Effect (more on both later).

The limitation in bandwidth is mostly effected by the Lowpass Filter composed out of the source-impedance and the cable's capacitance. A Bandwidth of about 100 kHz is desirable for this interface to make sure that the phase-shift and frequency response drop at 20 kHz remain acceptable.

The DA will determine time-smear and distortion of the Cable together with further second order effect and the third order effects.....

Let's look at Speaker-Cables.

Here the impedance's are, a source impedance of about 0.1  $\Omega$  to about 8  $\Omega$ . It is mostly resistive with small inductive component and the load is 2-16  $\Omega$  average impedance but has large reactive variations. Most Speakers also show an about 50  $\mu H$  - 100  $\mu H$  residual inductance from the uncompensated tweeter inductance.

Thus, unlike as in Interconnects, the Capacitance and DA can (mostly) be relegated into the second Order Camp. Due to the low impedance's in the load and the Source impedance of the Amplifier, the R and L of the Speaker Cable become highly relevant.

The Skin and Maxwell-Effects are being promoted from second order effect to first order Status. The bandwidth of the Cable and the frequency-dependent phaseshift will be a direct function of these parameters.

The Situation is complicated by the fact that certain amplifiers are very sensitive to capacitive components in the Speaker-load (NVA, NAIM, Linn to name a few culprits). So with Speaker-Cables indeed many bet's are off.

It seems that for Speaker-cables a low but matched R and L (so that the attenuation remains constant with Frequency over the Audio-band) is desirable combined with a low Capacitance and high quality dielectric.

It is essential that the Skin-effect and the Maxwell-effect are taken into account.

From my simulations and practical tests it also seems desirable to allow for an optional Speakerside "Terminator" Network. This should compensate the Inductive Rise of the Tweeter if required (depends on the Cables RL Values and the Speakers X-Over Design).

It may also be advisable to build into the Cable an (optional) Pi-Network at the Amplifier Side. This will ensure the stable operation of even the most "Hairshirt" designed Amplifiers and prevent RF Ingress into the Amplifiers feedback loop (if any is used) via the output.

First, Second - Third - who cares as long as we get to the Finish....

Having already touched on the Second Order Effects, let's look at some of these effects and how to avoid the negative influence of these.

The possibly most objectionable second order effect is due to the choice of the conductor. Here we could be using multiple non-individually insulated Conductors or the use of so called "solid core" cable.

A specific form of the Solid Core Cable is the so called "Litzendraht" a braid made from individually insulated (enameled) conductors.

True "Litzendraht" (Litz-wire) is braided similar to Kimber Cable and was originally invented by Nicola Tesla WAY BACK in time. Modern realisations are often called "Hyper-Litz" arrangements, why the "Hyper-Litz" I do not know.

Because these cables eschew the braiding and instead use simple parallel wires, they loose the Litzwire's advantage of canceling the wires magnetic field to a good degree....

Now let's look at the typical multi stranded speaker-cable, which may be the well-known "Monster Speaker-Cable" or the many clones sold by anyone from Radioshack/Tandy to Wall-mart.

This uses a large number of non individual insulated copper conductors twisted together for each Conductor. It is usually sheathed in transparent or clear PVC or PU. The Geometry is the so called figure-8 pattern, also called shotgun configuration.

Multistranded conductors have a problem. In an Ideal world, no electrons would ever "cross" the boundaries between the individual conductors. In the real world they do that all time.

(see Article Quantum Tunnel of Love, issue 8a,9a/92 of Bound for Sound)

Both the huge metal-to-metal surfaces themselves, crystal grain boundaries and surface oxidation make the interstrand conduction much less linear than conduction through pure copper.

In effect we introduce something not entirely unlike (but also not entirely like) the crossover distortion of a Solid State Class B Amplifier.

A solid copper conductor or a Litz-type wire will still have some non-linear conduction due to impurities and Grain-boundaries, but these are much less in magnitude.

Our next stops are Skin- and Maxwell- Effect.

The skin effect says that with rising AC frequency the electron flow is being pushed more and more to the outer surface of the Conductor.

It does not matter if a Conductor is 12 Gauge solid Copper, or a Conductor of a 12 Gauge multi-stranded Cable ("Monster-Cable"), both will appear as 12-Gauge solid Copper round conductors.

So, the higher the frequency, the more of the signal conduction will happen in the outer layers of the cable.

The conventional cables multistranded conductor will show even more problems, due the non-linear interstrand conduction near the surface, the presence of surface oxidation and the like. Can you spell Treble Grit....?

For all it is worth, the Skindepth for a round Copper Conductor at 20 kHz is about equivalent to the Diameter of a 20 AWG Conductor.

At this depth from the conductors surface the current density is 63 %. Hence a 20 Gauge conductor should not experience skin-effect related problems below 20 kHz. As I have already mentioned the 100 kHz Bandwidth Requirement we should really expand this to apply to the Skin effect.

It should be noted that the remaining current-flow between this depth and the surface is heavily skewed towards the surface of the conductor, so in more ways than one we'd rather like as thin a solid conductor as feasible.

It appears that 24 to 26 Gauge individual conductors make for a good compromise between bandwidth and manufacturing requirements (or the ability to adapt readily available commercial wire for Speaker-cables).

The Maxwell Effect works at the other end of the Spectrum (bass) and is a bit harder to explain. I will not even try. Read the Paper Prof. Malcom Hawkesford submitted to AES (Audio Engineering Society) if you feel like doing a bit of serious mathematical self abuse.

The Upshot is that a thin conductor will also IMPROVE the LOW-END performance. Hence the Conductor providing the widest bandwidth (measured and subjective) all else being equal is the thinner one.

A thin conductor introduces a lot of resistance, giving us problems with the Series Resistance in our Cable.

So we to use for example flat, thin and wide Foil Conductors to get the resistance down to a sensible level for Speaker-Connections as implemented for example by Goertz Cable, Sonolith and Magnan Cables.

Another option is to arrange a lot of thin individual Conductors in a Litz or "Hyper-Litz" pattern (XLO, Audioquest, Cardas, Kimber and Tara).

Either solution provides us usually with some problems regarding the Cables Geometry and hence often the RLC Parameters are shifted in ways that are undesirable.

#### **Let's summarise:**

A (universally) good Speaker-Cable has a low Resistance and Inductance (though a certain balancing Act is recommended for Speakers with a non-resistive impedance) and moderately low Capacitance.

It will ideally employ multiples of very thin round Conductors with individual insulation or use thin Foils.

It will not use multistranded Conductors and it will minimise both Skin- and Maxwell- Effects.

And where do the DIY Cables fit in?

The UBYTE-2 Cable, developed by me, conforms to most conditions.

An exception is that about one third of the Conductor-CSA (cross-sectional Area) for each "leg" is made up from 18-Gauge Solid round copper. This will restrict the Bandwidth of Cable slightly, but helps to utilise a relatively easily available commercial coaxial wire and to achieve a reasonably low DCR.

The outer copper Foil Conductor carries the major load of the current and conforms to the solid and thin model.

The specific geometry (as developed by Jon M. Risch) allows for a fairly good set of RLC parameters.

For a 5 m Length of Speakercable there is about 0.1  $\Omega$  DCR combined with about 1  $\mu$ H Inductance. The Capacitance is around 800 pF for 5 m.

Into a resistive  $6 \Omega$  load (respective of most modern tweeters + Zobel) load that will allow a - 3dB Bandwidth in excess of 300 kHz.

The maximum frequency response deviation over the 20 Hz to 20kHz frequency range for a Speaker falling to a  $4 \Omega$  Minimum will be about -0.2 dB. This will be at the  $4 \Omega$  minimum, as compared to an infinite load impedance.

So a DC to 60 kHz bandwidth with a +/-0.1 dB deviation from the 1 kHz point and minimal phase response deviation should be possible into a compensated Loudspeaker. The compensation may be part of the Cable if required.

That is not very good, but I think it a tolerable technical performance. In many cases the Output impedance of the driving Amplifier will produce larger errors. Many expensive commercial cables do not remotely achieve this standard of performance.

Also the FFRC - "Full Frequency Range Cable" is still very good with respect to fulfilling the requirements for high quality Audio.

The use of multiple individually insulated conductors of 24-Gauge thickness guarantees freedom from the effects of non-linear conduction as found in multistranded cables. The thickness is such that any skin-effect related problems are pushed out of the audiorange.

With a high quality insulation and a geometry to minimise inductance and capacitance even the lowly FFRC still is miles ahead of all multistranded cables, regardless of make or price.

I have carried out an extensive series of Measurements and PSpice Simulation that included popular Cables (like Kimber 4TC, Goertz MI-2, Cable Talk 3 and Reson LS-350 and others). These confirmed that both into a matched and an unmatched simulated Speaker-load the "UBYTE-2" Cable will give the overall flattest response.

The FFRC is not that far behind, but is solidly beaten by the Goertz MI-2 and ever so slightly by the Kimber 4TC.

The rest of the Cables was just terrible.

A partial exception was interestingly the Reson LS-350, a very thin Cable with a pair of widely spaced thin and solid conductors.

This cable has a high series-resistance and inductance. Most people and reviewers take an instant dislike to this cable because of the thinness of it's conductors. Yet it's bandwidth into a real-world Speaker was surprisingly large.

However with its rather thin cross-section it will likely not make a good match with quite a number of speakers, so as a universally applicable speaker-cable, it is not too well suited.

Hence I think it can be said that the basic engineering for both the "UBYTE-2" and the "FFRC" is sound and fit for the purpose.

The fact that it outperforms on measurements and listening tests almost any sensibly priced Speakercable on the Market earns the "UBYTE" (Usually Beats Your Terrible Engineering) tag for the "UBYTE-2" Speaker-cable.

In combination with (optional) Speaker- and Amplifier-Side Networks we can match this Cable to almost any conceivable combination of Equipment.

Various "audiophile" construction details (Air/Polyethylene Dielectric, Solid Conductors, Foil Conductors and the like) address many suspected but scientifically largely unconfirmed effects, detrimental to sound quality.

The UBYTE-2 has yet to be bettered by a commercially available Cable in the Mid-Price Range up to at least 30-50 Dollar Meter. I have not yet been able to try even more expensive cables in a head to head test....

In comparison, the "FFRC" is only "good". Its main advantage is material cost below many of even the most basic "Speaker-Cables" with a performance more akin to serious "High-End" Cable.... It also is much easier to make.

## The Naked Truth about Interconnect Cables

Oh no. Cables. Not that old HiFi chestnut again!

Quick, shut him up HE IS GOING TO TALK ABOUT CABLES!

The naked truth about cables? It is simply, that all this cable nonsense is Bovine Excrement!

I am sure some of your initial reactions where like this.

To write about Cables anywhere is an open invitation to be barbecued. Flame-bait par excellence. Still, I'm going to talk about Cables. And not just any Cables, I'm going to talk about Interconnect Cables.

And I'm going to say that Interconnect Cables make a difference.

Do you start to question my sanity? Well, I better type fast, so I can get this all out before the men in white take me away.

Honestly, Cables make a difference. And "wrong "cables can make the wrong difference.

In my experience speaker cables make the greater difference, maybe because they are usually a lot longer. Interconnects do however still make a difference.

True, neither type of cable will make a huge difference. Swapping the cheap and nasty NE5532 Op-Amp in a CD-Player Output-Stage for a really nice one (like the AD811 or my favorite Nat Semi LM6172) makes more of an audible difference.

To get the ultimate from your system, you need the right cables.

### So what's in a Cable?

Let's make a bold statement: "The best Cable is No Cable"

Let's make another one: "The Ideal Cable does not change the Signal traveling through it in ANY way."

Let's make a third one: "No Cable can improve the sound-quality of a system, they only make it worse in varying degrees."

And indeed, the best Cables I came across make things worse only a very little bit. The worst however....

I personally divide "effects" in audio into three "orders". These refer both to magnitude of effects and to the "obscurity" of the underlying principles.

First Order effects are those that produce massive and immediate changes to the sound. First Order Effects also mostly tend to have a direct, simple, logical and scientific explanation.

To elaborate, for interconnects capacitance is a first order effect. Use Goertz Interconnects (these are essentially unrolled capacitors) for a few meters and most sources will substantially roll off the treble due to the excessive Capacitance of the Cable.

Second Order effects make appreciable differences but are harder to pin down with logical explanations, though in most cases they exist and can be found.

To elaborate, the sonic difference between stranded cable, litz/hyperlitz cable and solid-core cable falls into this category, as does the dielectrical quality. Both matter quite a lot, but ultimately, if our cable has massive problems with First Order Effects any second order effects (for better or worse) will often be swamped out by these.

Third Order effects are way down and also, in many systems the resolution of the System is not high enough to seriously magnify the differences. In my own system I only begin to get a handle on third order effects.

I think the Conductor-material argument (silver vs. copper vs. plated copper vs. exotic conductors) falls into this category.

### Cables have a sound!?!? How?

I have said; the ideal cable does not alter the signal.

Sound is a complex acoustic waveform, transformed into electrical signals at the time of recording. It is these signals that we want to keep as intact as possible.

We can describe these waveforms in terms of timbral, dynamic and temporal accuracy. All these have electrical equivalents. For my various bits of accuracy a lot of math is around to do it all scientifically. I personally prefer to stick to the "popular science" approach.

Accurate Timbres mean the a voice or instrument sound exactly as we would hear them normally. It includes both the harmonic structure (so no harmonic or intermodulation distortion please) and the basic frequency response.

Accurate Dynamics mean that the Dynamic Swing of the Signal (music) from the recording should not be reduced. Most Cables usually manage that (as they are passive devices).

Accurate Timing includes a few effects. There is some heavy math from Prof. Malcom Hawkesford on the Maxwell effect, which stipulates that different frequencies travel with different speed through a piece of wire. Then there are phase-effects from both the lowpass filter function of the cable and the skin effect.

Now all these effects listed above can usually be quantified in one way or the other, though it is rarely done and many of these measurements are still being treated as suspect by "mainstream" audio.

If we know what to measure we can easily analyse all first-order effects of the Cable. This simple electric's. We need to determine the complex Impedance of the cable, read all the capacitance's, resistance's and inductance's in the cable.

From here on it gets fairly technical. If you just want to know which Cable I think sounds best and how to cheaply make yourself some, just go to Now for a bit of practical stuff.

## **The L, the C and the R**

To alter the sound passing through it least, the various parts making up the impedance must have such values, that little or no alteration happens for Audio-frequencies. Interestingly, (for me) Audio-Frequencies means 4 Hz – 100 kHz in order to guarantee no more than 0.1 db deviation at 20 Hz or 20 kHz.

If we look at the general impedance's in line-level interconnects, we find (usually) that the source-impedance is in the region of a few  $\Omega$  to a few k $\Omega$ . The load impedance ranges from about 10 k $\Omega$  to about 1 M $\Omega$ . The input capacitance is mostly very moderate too (100 pF or less). This provides us with some indication as to the relevance of the various electrical parameters that matter.

It seems that as long as the cable dc-resistance is being kept moderate (a few ohms) there will be little influence. The ratio between the cables resistance and the input resistance is very large. Indeed, the contact resistance of the RCA plugs used (terrible connector by the way) is often much larger.

A loop resistance of 1  $\Omega$  when feeding a 10 k $\Omega$  Amplifier input will cause an attenuation of 0.001 db.

The Cable inductance also matters little as long as it is kept moderate. The higher the load impedance is, the less relevant the Cable inductance becomes, the lower the load impedance is, the more relevant the cable inductance will become. Interconnect cables of about 1 m (3') lengths rarely have an inductance of more than 1  $\mu$ H.

At 20 kHz a 1 $\mu$ H inductor will have an impedance of about 0.13  $\Omega$ , causing an additional -0.0001 db attenuation.

Even with a 1 nF input Capacitance in parallel with the 10 k $\Omega$  Input Resistance (IEC Load) the attenuation by the Inductance is not significantly larger.

The Cable Capacitance is however crucial for interconnects. I hinted at that when I explained my "first order effects". The Capacitance to cause a -0.1 db Roll-off at 20 kHz with a 100  $\Omega$  Source Impedance is about 15nF. If our source Impedance is however 1 k $\Omega$ , a 1.5 nF Capacitance will cause this roll-off.

I have seen Output impedance's of around 1 k $\Omega$  in many pieces of mass produced Hi-Fi equipment. As the UK HiFi-Choice Magazine regularly prints Cable-Reviews that include technical sections with measurements, I can estimate the sort of maximal capacitance a cable may have. A capacitance of a few nF is easily accumulated on longer runs of various shielded cables, not to speak of the "unrolled capacitor" type Cables.

I would conclude that in line-level interconnection the DC-Resistance and Inductance of the cable are of purely academic interest. Constructions with significant resistance or inductance will likely not manipulate the sound of the signal passing through it in any significant way.

A capacitance as low as possible is however desirable. It seems also desirable to have the dielectric (read insulator) in the Cable to be of as good a Quality as possible.

Given my (and many other peoples) experiences with Capacitors, Teflon seems the best solid dielectric, while Air is even better. Polyethylene is also quite acceptable as dielectric while lesser plastics and specifically PVC are out.

Many commercial interconnect cables use PVC insulation.

## **EMI - all I heard a gentle HUUUUMMMMMMMMMMMMMMM**

Another one of my "first order effects" is of course the rejection of interference. This applies mostly to RFI but also lower frequency EMI can become a problem. The best rejection of external EMI and a good rejection of RFI seems to be achieved with woven constructions a'la Kimber and XLO.

Closely twisted Pairs are also good at rejecting EMI (about -47 db for the best) but the degree of RF rejection is not as good and capacitance is high. Most current commercial "specialist" cables use this topology.

The worst for rejecting EMI and RFI is a "linear pair". Here simply two widely spaced wires are used. At the same time, I nevertheless had good success with this configuration.

Another way to reduce RFI (but not much EMI) is to shield the Cable. Shielded Cables do of course have their own problems in first and second Order effects (though not insoluble).

A variation on the shielded Pair is a cable where the shield also acts the "cold" conductor. These cables are known as co-axial cables and are the mainstay for Audio. The rejection of EMI in a coaxial cable is quite good. The cable that came packaged with your CD-Player is likely a coaxial cable.

### **To strand, or not to strand - that is the question here**

(from Cabelitis, a very avantguard play - spoken by the Hero - the Son of an audio-cablemaker).

As we already mentioned second order effects, lets have a look at some other relevant ones.

In my experience all stranded Cables where each single conductor is made from several strands of copper that are not insulated from each other imparts an unpleasant harshness and brightness to the sound.

There are a few theories why this is so, if you want to read one of the more nutcake flavored ones, it comes from Ben Duncan. He proposes that copper-oxide forms between the strands that encourages non-linear conduction (little "mV" Diodes).

I shall keep out of this (there are pages full of letters on this in Wireless World), but as said I prefer solid conductors over stranded ones.

Litz-Style cables where each conductor is insulated from the others are usually much better or we can use single strands of solid core wire.

There is an argument that rectangular thin but wide conductors improve at the frequency extremes. Short of using Foil Tapes, one can use a few thin and round conductors (say 42 Gauge Magnet wire) run parallel, similar to the style of Cables from Nordost.

One more second order effect is the interaction of the signal current (as small as it is) with the shield. This will induce eddy currents in the shield that again will degrade the sound. Plenty of spacing helps but again, it reduces the effectiveness of the shielding.

### **Gold plated zirconium Cable in Carbon gels anyone?**

Third order effects as said are mostly shrouded in mystery and I have not found much of handle yet. There are people that dislike silver-plated copper intensely. I have not found that myself, however. So there you just follow your ear or your guru.

There is the issue of conductor shape or diameter. All sorts of other neat little theories, including my own one.

I for example say, that immersing the raw conductor in specific oil which is produced from a very rare and highly poisonous snake found in the Brazilian rain forest (and long on the list of endangered species) will provide more "texture" to the music as well as more "bite" to violins. The immersion process needs to be undertaken by certified vestal virgins who are sacrificed to the Audio-God's after completing their task.

Unfortunately this is a very expensive process due to large numbers of native red Indian's who are bitten by the snakes when trying to collect them to get the oil as well as the large number of snakes needed to provide a small measure full of this precious oil. Also vestal virgins are getting kind'a rare (have I used them up too?). So do not expect an industrial application anytime soon.

But I'm sure it works.

Just believe me and buy my cable.

It's a tad bit expensive, but you see, all the payoff's of the widows, orphans, virgins parents and so on....

### **The "Full Frequency Range Cable"**

#### **A better Mousetrap, a better Mouse, a better Speaker-Cable - why?**

The most relevant cable in any system that is not using a monoblock amp positioned behind or near the speakers is the speaker cable. It tends to be the longest and has to carry the largest amount of current. A Speaker-Cable is also most sensitive to geometry and due to the fact that it has to carry a lot of current all this becomes a lot more complex to handle than for interconnects.

As a result, as far as my humble opinion goes, most cables marketed as speaker-cables are entirely and totally unsuited for this task, at least where high quality reproduction is a requirement.

Specifically, the usual Figure 8 Cable with fairly large, multi-stranded Conductors is sonic poison. If you use this stuff, even switching over to simple 1.5 mm solid core mains cable will bring substantial improvements....

So, just like most commercial Mousetrap's do not really catch many Mice, most low - to mid - priced commercial speaker-cables are simply not very good as speaker-cable.

Hence we need a better Speaker-Cable.

It should be not only be good, but also inexpensive and easy to make.

While I remain convinced that few commercially made speaker-cables (even really expensive ones) perform much better than the "UBYTE-2" speaker-cable, this cable is fairly expensive and very time-consuming to make.

Often I found an E-Mail in my In-Tray saying "I'd love to make one of dem "UBYTE-2" Cables, but to be honest, is there not maybe something cheaper and easier to make?"....

Well here it is.

After lengthy consideration I choose not to apply the UBYTE Moniker to this Cable. Remembering Decca's revolutionary "Full Frequency Range Recordings" (FFRR) I decided to give homage here, by naming the best Speaker-Cable for the economically challenged "FFRC", the "Full Frequency Range Cable"....

### **How to make a better Speaker-Cable!**

In order to make a better Mouse-trap, we need to study Mice and other Mousetraps. To make a better speaker-cable, we need to study speakers and speaker-cables. I have already done this and written an Article about it: "The Naked Truth about Speaker-Cables". Just look it up....

In the end, the most basic conclusion was that each single of the wires making up a speaker-cable should be solid copper (or silver), no larger than 24-Gauge (0.5 mm Diameter) and individually insulated.

Further it can be said that a geometry should be employed that reduces Inductance and resistance to a sensible level, combined with having only modest Capacitance so that "twitchy" Amplifiers are not being upset.

A Cable lending itself splendidly to these requirements is Category 5 Network-Cabling for fixed installation (also called Unshielded Twisted Pairs, UTP, 100-Base-T).

Each of these cables has four pairs of solid plain copper conductors, each being 24 Gauge in diameter (or in some cases 22 Gauge).

Some similar cables have stranded, tinned or even copper-plated aluminum or steel conductor-based wires - avoid these at all cost. Usually the Insulation is polyolefin, an insulator that is modified polyethylene, which is a rather good insulator.

Similar cables are available as a 'plenum' version, using teflon insulation and often also teflon jackets. This cable is preferable, but expensive.

Personally, I use a cable from Maplin (a well-known UK electronics mail-order house). It is made by Alcatel, uses polyolefin insulation (PO is modified polyethylene) and a low smoke zero halogen sheath in a fetching purple colour.

The Order-Code is VB20W. Maplin will sell and ship into any corner of the world, but I am sure with a little effort you can find the cable locally.

Now, how much does a meter of this highly specified, capable of operation at 100MHz, audiophile super quality wire cost?

Well, it depends upon type, maker and where and how much you buy.

The stuff I use (either in purple or neon blue) comes in at about 50 Pence (that is 80 Cent in US Money) per meter if I buy it cut to length...

Buy a large reel and it goes down to about half that....

### **Details, details, details - get on with it....**

Looking at the resistance of the conductors, it becomes quickly clear, that a single set of these cables will still have a lot of resistance. Those of you using 16  $\Omega$  Lowthers or 15  $\Omega$  BBC Mini-Monitors may be able to get away with one run.

However for most of the more usual Speakers we like less resistance and more often that not bi-wiring. So a single run of this Cat 5 cable will not do.

The "FFRC" is be a Cable for use with "normal" Speakers. It is designed and optimised for bi-wiring. It has a good compatibility to a wide range of equipment.

It looks like a high quality and high price commercial cable, with a sound quality like some of the better High-End cables.

It will also cost no more than 45 UK Pounds, that is about 75 US Dollar, for a terminated 5m Stereo bi-wire pair....

Simply buy about six times the length of Cat 5 Cable that we want our final cables to be.

Say for a five meter pair of cables you will need to buy about 36 m of the Cat 5 cable. This includes a bit for loss due to termination, twisting and cut-off's.



Take three lengths (say 3 x 6 m for the example above) of this cable and twist them together with about one twist per foot. It is best to fix one end of the set in a small vice and then start combining the three cables. If you feel like it, you could use a braided structure like the one shown for the TNT-TTS Mains-Cable.

I then cover the resulting "braid" with expandable braided nylon sleeving, 13 mm nominal diameter.

If you don't feel like doing this, you can save money by leaving this off. Simply use a set of cable-ties on each end of the cable to prevent it from unraveling....

The braided sleeving does however make for a very professional look. I use it on all my Cables. The braided sleeving is available in gray or black, so you can make the finished cable less conspicuous on your floor or carpet.

The sleeving does cost about US\$2 per meter. Maplin stocks the gray stuff only. The order number, for those interested, is BA00.

In order to keep the ends of the braid neat and tidy I use a short (about 10 cm) length of large Diameter heatshrink sleeving. This is applied once both Cable-Ends are terminated.

It finishes off the Cable with a look as if it has just left the skilled Hands of highly qualified worker, at a high quality and high-end Cable manufacturer....

And guess what - it is exactly what it looks like. You have just joined the the Elite Guild of High-End Cable Manufacturers....

### **Connections, connections....**

Now we have a cable having overall 12 pairs of individual solid copper conductors. Each conductor is about 24-gauge. If all conductors are used together, we arrive at a cable of about 13-Gauge cross-sectional Area of Copper. There are different ways to terminate and connect this cable.

My preferred termination's are Radioshack/Tandy Spades #316A. These are gold plated copper and cheap (about US\$5 for a pack of eight).

If you do not like spades, the best sounding Banana-Plugs I know are available from Maplin. They have hollow, goldplated, beryllium copper pin's, are marked in red and black and cost 1.29 UK Pounds each (that's about 2.15 US Dollars).

The Plugs are stackable and the ordercode is MF68Y (red) or MF69A (black).

My preferred method of connection is to use two of the three cables in our braid for the woofer connection and the third for the tweeter.

As the cable's inductance is fairly irrelevant for the woofer, I suggest to just connect all conductors in each of the two individual cables together.

So one cable will carry the (+) and the other the (-) connection for the woofer.

Twist all the eight conductors for each of the two woofer cables together. Then cover the set of conductors with a suitable colour (red or black) heatshrink sleeving to mark the polarity of the leadout wires. Now apply the termination (Spade or Banana-plug).

The remaining cable in our assembly is used for the tweeter connection.

All white plus coloured ring wires are connected together for the (+) connection to the tweeter and all coloured wires as (-) connection. This connection provides a very low inductance and hence the widest bandwidth for the Tweeter.

At the amplifier end combine all the relevant wires (all positive and all negative wires) together so that you can use two spades (or Banana-Plugs) per cable.

Twist all related wires together, then crimp the spade connectors (or banana plugs) on and solder with a little silver solder to make the joint air-tight.

Obviously, at the speaker-end of the cable four spades (or banana plugs) are used. If you do not want to use the bi-wire option, you can combine the wires into two connections also at the speaker-end.

However, making the cable bi-wireable gives you the flexibility for a later time, where you might own bi-wireable speakers. For non-bi-wireable speakers, simply connect both (+) connectors to the (+) binding-post on the speaker and the other two to the (-) binding post.

From my experience with most Speakers it is however advisable to apply bi-wiring and if they do not have the provision to modify them to allow bi-wiring.

The result of your toils is:

a 5m pair of bi-wire cable that looks (and sounds) like a serious high-end cable for a total outlay of about 45 UK Pounds or US\$75.

As usual have fun trying this.

IF you are ordering anything for this Cable from Maplin, do yourself a favor and also order the materials needed for the UBYTE-i or X-1.5 Interconnect. With either the X-1.5 Cable or the UBYTE-i cable as interconnects and the FFRC as speaker-cable you have an excellent level of cable-quality for your system.

Sure, any of these cables can (and has been) bettered, but it takes a lot of work and money to make something notably better and it takes obscene amounts of money to buy anything better....

## **The Naked Truth about Interconnect Cables**

### **Now for a bit of practical stuff**

To get serious again, my personal cables have for a long time used 30 Gauge silver-plated solid copper wire with extruded PTFE insulation as conductors.

Sounds expensive? Like the stuff they make the really expensive cables from? The cables with price-tags that look like the serial numbers on Japanese stereo equipment?

Well, how about 12 English pence per meter? That is 30 Deutsche pfennige or 20 US cents. Sounds affordable?

It is sold as "wire-wrap" wire. In the US the source is Radio-Shack, in the UK you can buy the stuff from Maplin, my local electronics shop. For the rest of Europe; I'm not so sure where to buy the stuff, have a look around.

For anything anywhere near this price this is the best-sounding wire I know of.

It is rated at 300V RMS and I use it literally everywhere, where no high currents are needed. That means all internal wiring in Pre-amplification Circuits, their Power-Supplies, power-amplifier input circuits, CD-Players Audio-sections as said everywhere.

In the last year or so I have tried many different geometry's and construction techniques. I have every now and then strayed and tried different conductors. I keep various cheap commercial cables around as a regular reality-check (just in case I start imaging things) and I did do many AB tests with various cables, both blind and sighted.

I have found in all of this two geometry's that worked and where "makeable".

### **It is Number one - the lanky one with the two parallel conductors**

The first geometry is a "linear pair" in either shielded or unshielded form.

I use "Low Loss Satellite" Cable as the Cable "base". This cable has a plain copper-foil shield, an air-cell polyethylene Insulation (okayish due to the Air) and a solid core center conductor.

Maplin sells the stuff as FT100 for about 90 English pence per meter. I pull the center conductor out of the cable (a bit tricky but manageable) and use the "air-cells" to run two lengths of the wire-wrap wire from one end to the other. For cables of up to about 1.5m all this is quite manageable.

The RCA-Plugs are the largest style of the 4-piece Teflon insulated ones Maplin sells at 1.99 English pounds each.

The former Center-conductor now contains Air (1 mm Diameter) and there is the polyethylene and Teflon insulation, making for a decent (but not particular outstanding) dielectric. The Cable is not twisted, but even my Valve-preamp's high output Impedance (around 2 k $\Omega$ ) does not cause any hum pickup.

I do not connect the shield directly to ground, but instead run it out completely isolated. It is connected to a little box with a binding post that is then connected to a Ground-wire of special construction. The Ground-wire is a 50  $\Omega$  Coax-cable with foamed Teflon insulation. The shield is connected to spade connector (Tandy/Radioshack 316-A) but insulated from the center.

The center is connected to the binding post in the little Box. The Coax is about 75 cm long. This gives us a very high quality capacitor of about 50 pf with pretty good RF behavior.

RFI is successfully cut down notably on a version of the same cable without shield, while the sound degradation is minimal.

## **It is Number two - look how twisted he is**

The next cable project is a bit more involved ambitious. I use six parallel strands of the wire-wrap wire wound around a plastic/air core stolen from the FT 100 Satellite Cable in what is termed XLO-Geometry.

Big ThanX to Lance and all the others from the London Live DIY Circle who put me onto this one.

Here the parallel conductors are wound around the core in a pattern where they cross each set in an angle of about 90° or more. The conductor sextets cross each other in such a way that first the first sextet passes below the second sextet and then (on the opposite side of the tube) the second sextet passes below the first. This way, if wound tightly enough, the wire will hold itself on the core.

The best thing to do is to find a dealer who sells XLO Cables and to have a close look.

To make the cable, take a piece of the core of about the length you want the cable you are making to be.

Remove the copper center conductor.

Get 12 Length of the wire-wrap wire, each about 1.3-1.6 times the length your interconnect is intended to end up with. To illustrate; for each 1 m (3') length of interconnect, you will need 12 pieces of 1.3 to 1.6 meter (4 to 5 ft) of wire-wrap wire.

I use three pieces each in black and in red (for hot) and another six pieces in white (later cold).

I take each sextet (the lack-red one and the white one) and use electricians tape to make sure the six conductors stay together. Use the tape only for about 2.5 cm (1 inch) or so at ONE end of each sextet. The other remains free.

I then start to put each set of conductors at an approximate 45 ° angle to the core, one on each side of the core. A bit of electricians tape (later removed) holds them in place.

Now (for about 30-45 minutes) it is simply passing the conductor sextets around the core, while observing the spacing/angle and the "over - under - over - over" regime as to how the conductor sextets cross each other.

Every few turns it will be beneficial to pull each single conductor VERY tight (without tearing them apart), so the conductors will stay in place.

You will also find that the ends of cable become tangled. Untangle every few turns and you will be fine.

It is best to have a beer handy and to adopt a very philosophical view of live while making this cable. Just tell yourself that no good sound can come where there was no sacrifice.

My first set was an absolute torture. By now I'm up to speed and it only takes me about two hours to make a 1m pair of interconnects (including termination).

For the termination it is important to either glue the ends of the cable down on the core or to keep the ends as short as possible. Then terminate the whole cable in such a way that the core will "push" the two plugs apart, thus keeping some tension on the wire.

For your first set you may want to try glue.

## **But how does it all sound?**

First off, these are my personal impressions. They where gained both through sighted and unlighted listening, but are not conclusive or in any way dogmatic.

Generally I have found the XLO style of cable to be superior to foils, twisted and linear pairs, cables of coaxial or triaxial construction and to the Kimber PJB style braid.

Short, the best stuff I had in my system.

Still, the cable is not absolutely neutral, but imparts an ever so slight brightness to the sound. Some people will attribute this to silver-plating. I don't know. The effect is not unpleasant and VERY slight. This brightness is not the "edginess" of many lesser cables. If found it more notable with LP, maybe an effect from the Goldring Elite Moving Coil Cartridge I'm reviewing at the moment?

When comparing the Number two to the Number one interconnect, the main improvements are at the frequency extremes and in sound-staging. The bass is more extended, as is the treble. There is more "air" around individual instruments, while they are also more clearly "focused" (observation from my own blind listening to both cables).

When compared to the Radioshack/Tandy "Goldpatch" cable, there is a very noticeable muddling of the sound with the Goldpatch. Vocal sibilants appear to be "clipped" and bass lacks focus.

English is not my native language and I find it much harder to follow complex lyrics when the Goldpatch is in the system (Rhiannon - Fleetwood Mac on Vinyl) or cannot understand them at all.

## The UBYTE-2 Speaker Cable

Almost half a year ago, following on from some research into Speaker-Cables, various Articles, conversations with a lot of people on the Internet and finally a number of Usenet posts from Jon M. Risch, I made the first incarnation of the UBYTE Speaker-Cable. The UBYTE Moniker was coined by Pat from Analog Research and stands for "Usually Beats Your Terrible Engineering".

This Cable is similar to the Cross-Connected Belden 89259 75  $\Omega$  Coax Cable Mr. Risch recommends so highly. However, I decided not to use the Belden 89259 as it a bit hard to obtain. In addition all the Conductors in the Belden Cable are stranded. In my experience this is not such a good Idea.

The Cable used for Speakers in my system at this time was a "double run" of Category 5 network-cable. Both lengths where twisted together, based on suggestion from fellow Joe-netters. (The Joe-Net is the Soundpractices E-Mail list, mostly concerned with Single-ended Valve Amplifiers of minuscule output but often a lot of useful info is on there too.)

This Cable had replaced the 12-Gauge Mega-Cable sold by Tandy/Radioshack (not a bad cable for the Price by the way) resulting in major Improvements for clarity and transparency. I still recommend the Category 5 Network Cable as the cheapest decent Speakercable and for many the performance of a pair of these Cables may very well be all they ever want or need.

However, just like any Audiophilia Nervosa Sufferer, for me there is no such thing as good enough....

The original UBYTE was different from the Design proposed by Mr. Risch in that the Cable used had a solid (not stranded) Center Conductor and a Copper-Foil Shield with a thin Braid over the Copper. Unfortunately, the Jacket Material is PVC, not so good, but in this application just about tolerable. This Cable is sold under the CT100 and FT100 Designations respectively by RS-Components and Maplin Electronics. It is covered in the DIY Cables Resource Guide.

This Cable was very good and had me really excited. It stayed in the System for a good while, but I finally decided to address the two things I was unhappy about in the original UBYTE Speakercable. I was unhappy about the PVC and (much more) about the outer Shield Braid used on this Cable as this introduced a certain amount of multi-stranding to the Cable.

In case you want to make a VERY GOOD Speaker-Cable, below you will find detailed instructions how to make such a Cable. As for the Electrical parameters of the Cable, I have measured (for a 5.5m long Cable) less than 0.2  $\Omega$  Loop Resistance (including the Spade-Connectors fitted) and a Capacitance of about 800 pF. These values are similar to those for the Kimber 4TC Cable.

Where the UBYTE excels is low Inductance. For the Cable as constructed there is less than 1uH overall Loop Inductance. Compared to the Cat 5 Cable Twisted Pair the Inductance is reduced by the factor 3 to 5, compared to Kimber 4TC by still more than 2. Another Plus-point is the fact that this Cable combines two of the most individual (and good) sounding approaches to Speaker-Cables.

Cables using a moderately thick solid copper conductor (like the DNM/Reson Speaker-Cable) have a tendency to be extremely good in the Midrange and with human Voices. The Frequency Extremes are treated less well. On the Other hand, Copper-Foil Cables (like Goertz Alpha Core) have excellent Performance at the Frequency extremes but are a Load many Amplifiers simply cannot drive.

Combining both approaches gives an excellent Balance between Midrange Detail and Naturalness on one hand and good extension on the Frequency extremes. I believe that this Cable has to be heard. It was for my System a "Quantum-Leap" similar to the one the X-Cables provided for the Interconnects.

## The Construction of the Common Carpet Python

Your mission, should you accept it is to go down to the Electronic DIY Shop and buy all ingredients and assemble a pair of UBYTE-2 Speaker-cables suited to your own installation and listen to them.

Accepting the challenge? Read on. To wet your appetite, here a picture of the completed common carpet python in its natural habitat.



### Let's shop

Get "Low Loss Satellite" Cable. This is highly important as only the right base cable makes for the magical U-BYTE Cable. This Cable uses a solid copper center conductor (stay away from copper-plated Aluminum or Steel but take silver plated solid copper where offered) of about 1 mm Diameter.

It also has a full copper foil shield (not metalised film or aluminum - never use these) with a relatively sparse plain copper braid over the Copper Foil. If it does not have the copper foil, it's NDFG (could be read No Darn Flipping Good) for our purposes.

The Cable in question will have either foamed Teflon or Air-cell polyethylene Insulation (foamed Teflon should be better). The whole Diameter per cable will be 5-7 mm. Buy twice the length

needed (for example, for two 5 m runs of speaker cable buy 20m of the Cable....). The cost should be around 1 - 1.5 USD per Meter.

Also buy heatshrink sleeving with a large enough diameter to accommodate two of the Satellite Cables side by side. It has to be long enough to run the full length (for the example above 10 m Heatshrink with about 20 mm shrunken diameter). I personally used white heatshrink. I also found once I got home that the 10m Reel I had bought had only 8 m on it... Hence in the Photo above there a few parts of the cable not fully covered. I think it actually makes it look cooler....

You will also need white and red colorcoded Heatshrink for about 5 mm Diameter in shrunken condition. The Heatshrink should be at least of the Polyolefin variety but Kynar or Kyp Heatshrink is a lot better. You will need exactly the same length as the Cable you bought (for the Example 20 m).

Buy four sets of your favorite termination. I prefer Radioshack/Tandy goldplated Spades (code # 316-A); they are copper and cheap. Get the ones for 16 Gauge Cable.

You will also need about two spools each of black and two spools of red 30 Gauge Wirewrap Wire. Another ingredient (though by no means essential, but it makes the Cable look better) are four small long Rectangular Boxes (plastic or metal) with about 30 mm X 30 mm crosssection and about 100 mm length.

See to pick up some PTFE Tape (Plumbers Tape). About 5m will be plenty.

Now go to the usual place to obtain copious quantities of snakeoil and fairydust (buy a little extra....). Bat-Ear Powder is also highly recommended in this application.

Having gotten all these goodies safely home prepare a source of heat (Heatgun will work well), soldering Iron, Kester 60/38/1/1 SN/PB/AG/CU Solder (Call it Wondersolder, sprinkle Fairydust and snakeoil on it or don't bother) and plenty of space (which we all know is the final frontier).

### Let's twist again, like we did last summer...

Got that? Fine!

The first step is to make flexible Leadouts for the Cable. These should start with 36 strands, 35cm long each, of the Wirewrap Wire. You could just pull them trough a suitable size Heatshrink sleeving. Better, you can make a multiple twist "braid".

For this take six strands of the Wirewrap wire and twist them between your fingers. For the red Wire twist clockwise, for the black, anti-clockwise. Once you have made six sets each of the six twisted wires, twist these six sets together to make a very flexible, low inductance and decent looking leadout wire. Again twist the red stuff clockwise and the black anti-clockwise.

Put the Termination you decided to use (WBT Banana Plugs, Radioshack Spades or whatever takes your fancy) onto one end of the leadout-wire. Indeed, I have found that stripping the insulation off from each wire before braiding them and twisting just these ends together tightly allows for much easier twisting. Putting all six finished Mini-Cables into the Plug, Spade or whatever you use before twisting the six sets together makes this job again a lot easier. Trim the other end of so it looks neat and all wires have the same length.

You could of course buy short length of Cardas OEM Wire (in 15 Gauge or more) or any other Cable that avoids multistranded wire. In the End, one way or the other you should now have four red and four black leadout-wires with some form of termination on the end of the wire. I always crimp my Radioshack Spades onto the Cable using extreme pressure to achieve a "coldweld".

Finally remove the insulation from all the single wires on the other side of the cable (the un-terminated one). You will have to untwist for a few cm and retwist it after removing the insulation for that.

### **More than an arm up these sleeves**

Now take for every length Cable needed two sets of the Coax Cable (continuing with our example - four 5 m Ends). Please mark the Ends for the Direction how the Cable came off the Reel. I have not found Cables to behave directional, but one never knows. It certainly will not do any harm.

The next step is to take each End of the cable and a sharp Stanley knife and to cut through and remove both the PVC Jacket and the copper Braid. To prevent the Copper Foil of the shield from tarnishing it is best to wear gloves.

Please be careful at this step. It is easy to tear the foil if the Cable is bend to much rendering the whole length unusable.

After stripping off the "Acne" of the Braid and jacket, solder a 5 m Long Draw-wire (solid core 1 mm mains cable works for me) to the Cable. I recommend to solder the draw-wire to two of the Cables on the start side of the Reel (remember we marked them?) and the other two to the end side of the reel. Use the red Heatshrink on the cable having the draw-wire on the start-side and the white heatshrink on the other two.

Re-sleeve the cable in the smaller Diameter Heatshrink (probably 9.4 mm unshrunk). The Draw-wire helps immensely pulling the Cable through the Heatshrink. Shrink the heatshrink carefully and step-by step (do not coil the cable up and put it in the Oven!!!).

As a result, we are now left with four lengths of Cable consisting of a solid copper Center, an airspaced polyethylene(or Teflon) insulator, a solid copper-foil shield covered tightly by Polyolefin (or Kynar/Kyp) Heatshrink. Two lengths will white and two will be red. There will still be a >5m Long draw-wire be soldered to each.

Now Take one of the length each in white and red and lay them out in parallel on the Floor, so that now both draw-wires are also parallel. Get the large diameter heatshrink over them taking care to leave about 15cm at each end exposed. Again, the Draw-wires help a lot. Shrink the heatshrink tight. You could twist the cables around each other; but noting the comparable fragility of the Copper-foil, I decided against it.

Fill the whole assembly with some snakeoil while we are there. We now have two raw ends of the "Common Carpet Python", waiting to be terminated with our leadout wires.

### **Terminator X – terminating**

Finally time to put all these little and large bit's together to get a working cable. Zen being what it is (and when making complex DIY Cables like this one a lot of Zen is needed together with a few beers....), we should concentrate on the process and not on the result, but in the End, no matter how nice it looks; we are in this for the MUSIC.

Get one end of one Cable. Take off about 5 cm of one of the two Cables. It does not matter of which of the two as long as you retain consistency throughout both halves of the Stereo-pair.

Drill suitable holes into the rectangular Boxes you bought, so that the two Coax Cables and their overall Jacket can go into on one end and the flexible Leadouts in the other. If you use metal Boxes, make sure to use rubber grommets to prevent the Metal corners from cutting through the Cables insulation.

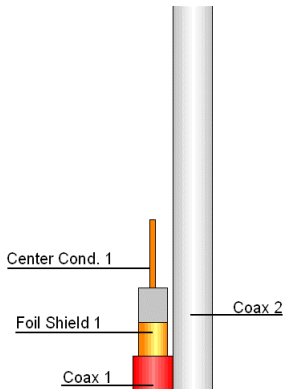

Strip 2.5 cm of the jacket, copperfoil and inner insulator off the shorter Cable. Remove another 2.5 cm of the outer insulator. Cut back the copper foil (I used a small Scissors) by half of this distance. Your assembly should now look like this....

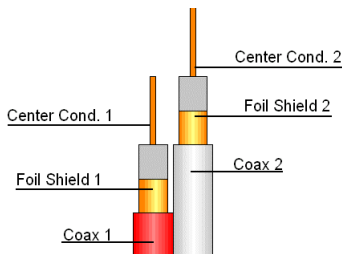

Now repeat the same process for the second Coax Cable, but here Strip the center conductor bare for 5 cm not 2.5 cm. The result of this should look like this....

The Center-conductor for the first coax should be exposed for 2.5cm; for the second coax 5cm. Take this End of the Cable and slip the (open) box prepared over it. Insert also the two Leadouts, so that the black one is near the white sleeved coax and the red one is near the red sleeved coax.

Now take the exposed center conductor of the first coax and bend it at right angle over to the other coax in the cable. Wrap it halfway around the copperfoil and then put the exposed wires of the appropriate leadout wire (in our case a black one) under the centerconductor and above the copperfoil. Spread the individual wires out so that there is plenty of intimate metal-to metal contact between foil and leadout wire. Finish wrapping the center-conductor tightly around the copperfoil. Then solder the area with the leadout wire quickly and with plenty of flux and heat.

**BE QUICK OR YOU MELT DOWN THE INNER INSULATOR AND CAUSE A SHORT!!!!**  
Such a shorted cable may destroy your amplifier!

This is what you should end up with....

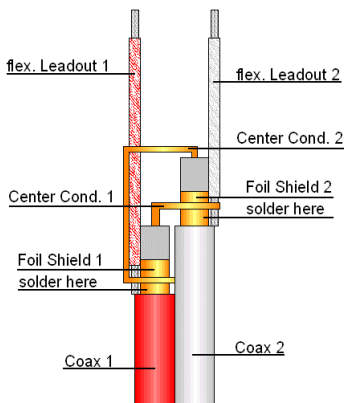
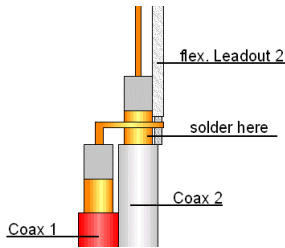

Now bend the other Center Conductor across and down (now you know why it's 5cm long) and repeat the process form above for this side. The endresult should look like this....

Of course all of this should be inside the small metal or plastic box. In certain cases the Boxes in which we fitted the Junctions, can be used to hold "mystical, magical, snakeoil and fairydust treated" U-BYTE Load Stabilisation, RFI rejecting networks (we talk about that in another article in detail).

With these Networks in place these cables can be used with amplifiers from Linn, NAIM and NVA (and all others that eschew the use of load stabilisation networks and thus carry serious health-warnings about which cables to use with them and which not). They also help with badly designed speakers that have no compensation for the tweeters Inductance.

Now take the PTFE Tape and wrap all of these connections and exposed copper up (like the mummy's of old...). Wrap tight and then sort-of press the layers down. This makes a pretty airtight seal, preventing the junctions from oxidising.

Use Cable Ties to provide a strain-relief for both the flexible Leadouts and the double coax. Complete the other end of the Cable; this time taking care to cut the 5 cm of the other coax (so if started as shown to chop the red cable short, now take the white....) and then complete Cable number two.

Given that all of this was a huge load of work, put everything aside and have a glass of your favorite liquid or two. The next Day measure the Cable to make sure you did not "fit" any shorts.

Now apply further copious amounts of snakeoil and fairydust before you drop the Cable into your system instead of your multikilobuck stuff (or the cheap Ratshack Monsterwire).

Put on music. The cable may get better with use, but I hope you hear what I heard when I put it my system immediately.

That's it for today. Have fun. Enjoy the Music.

PS. If anyone uses Speakers without HF Impedance Correction, get an 6.2  $\Omega$  Carbon Composite Resistor (2 Watt - non inductive) and a 0.47-1  $\mu\text{F}$  Siemens stacked Film Capacitor (or equivalent) and connect these across the cables at the Speaker-end.

If you use NAIM Amp's (or others that warn you about using highish capacitance cables) make three turns around a 6 mm Core (say a piece of a cheap plastic Biro) in each of two leadout wires at the Amplifier side, and connect a 10  $\Omega$ , 0.1  $\mu\text{F}$  Zobel across the cable at either side of the small Inductors (making a symmetric PI Filter in essence).



Now we made a Network Cable, which in addition is directional. This of course calls for more fairy dust and Snakeoil application.....

Ps. Ps, I hope you do not take the references to fairy dust and snakeoil literal. These are costly substances and are not needed in the DIY version of the Cables. The Commercial Version of the Cable will need lots of it of course..... :-)

## Speaker cables TNT Triple T



### The Twisted Twins! :-)

Product: TNT Triple T speakers cable  
Company: not for sale, TNT-Audio free DIY design  
Approx. cost: 10\$/Euro (just cables)  
Author: Stefano Monteferri

### Foreword

It's been a long time since I made the cables I'm presenting here, yet I have never seriously thought of them as a project for TNT Audio. I thought the topic was a tad redundant, due to the presence on the same TNT pages of the famous FFRC, and due to several other designs, all made up from the same CAT 5 UTP network cable, spread around the Net and much discussed on our discussion group. So, I'd rather avoid adding my opinion on it.

At least until when, during a period in which I was particularly interested in experimenting with different kinds of cables, I actually ended up making almost all of those projects plus other that I knew, all based upon CAT 5 cable. I systematically found their characteristics much weaker than my own cables' (and this with almost every system I happened to test them).

Moreover, considering the positive feedback received from various audiophiles - whom I "confidentially" told about my design - after they made them, I made up my mind to publish my project to all of you TNT Audio readers.

Let's state it clearly: I am not saying this is the best speaker cable design sporting UTP CAT 5 wire, but only that, based on my listening experiences, and using my evaluation criteria, I just didn't find anything better. That's all.

While I am writing this article, I haven't chosen a name for them yet, but, due to their geometry, I'd say that "The Twisted Twins" could be more than good! :-)

Now, let's take a good look at those "TNT tripleT"!

## Making the cables - Let's Twist Again!

The basic material is, as already stated, network cable UTP CAT 5, sporting 24 AWG solid copper conductor - just make sure it's the best quality you can get.

The total length is the sum of the desired length, plus about half a meter needed to compensate for what you are going to lose due to the "twist" and the terminations. In other words, should you want to make a pair of 3 + 3 meter-long cables, you must take into account 3.5 meters and multiply the total times 12 (ex:  $3.5 \times 12 = 42$  m). That kind of network cable is pretty easy to find at a very cheap price (about a 0.25 Euro/meter, at least in major cities, so you need only a little over 10 Euros for all the stuff).

From the above calculations, you clearly guess that for each channel you need six length, making a "seriously" dimensioned cable. Those six segments of cable will form three "twin" pairs that will be twisted together, like our TNT-TTS power cable (I'd say that the pictures are very explanatory).

**It's recommended to keep the twin pairs always coupled, and not to overlap them while twisting them, in order to realize a rather "flat"-looking cable.**

Some advice: if you have to make a long cable, start from its center (it will be easier to periodically unroll the cables you are twisting), and keep the same direction for all the segments of cables (you just need to look at the writings on their outer sleeve).

When you are finished twisting, after having fixed both the edges of the braid with some tape to avoid it loosening, start peeling the cables. Open the sleeves for a dozen centimeters, taking care not to cut the internal conductors, and (provided you don't have the right tool) use a simple lighter to heat, one by one, all the little wires (that you have already untwisted) up to a couple of centimeters from their edge (be quick, or else you'll get a big flame: you'd better practice a little bit on a spare piece of cable...:-). Once heated, the sleeve is easy to peel: simply grab it with your fingernails and pull with decision, in order to avoid any mechanical stress to the inner solid copper conductor.

Twist all the white cables together, and twist all the coloured ones together. Finish them with your favourite terminators (rounders, spades, bananas, silver soldering, etc.). What you have just finished will be the amplifier side.

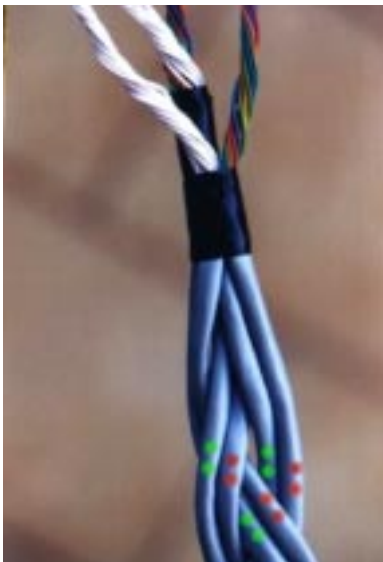

Detail of TNT tripleT:  
watch out for the coloured signs!

The "TNT tripleT" speaker cable is set for biwiring, so that all the terminations, speakers side, will be a tad different: for each way, you use just one wire of each "twin pair". In practice, look carefully at the cable you made up to this point. Select the right-side cables of all the pairs (as an example, take a look at the picture that particularly shows the red-coloured cables). Peel the sleeve off all three cables, free the pairs, separate the white wires from the coloured ones, and twist them together.

After making the same thing with the remaining three segments (that is, the left-side cables of each twin pair - the green-coloured ones in the same picture), peel the wires with our usual lighter system and finish it with your favorite terminations.

After finished the first cable, repeat all for the second one, and that's all!

If you don't want to bi-wire your speakers, you can connect both the terminators to the single speaker inputs. I personally opted for the bananas, for evident comfort reasons (being a reviewer, I often need to switch cables, and bananas are the most practical and fastest way to do it). I could find some of a kind - rather cheap, indeed (about 1 Euro each) - with which it is possible to serially connect the pair of terminators: in practice, each banana plug is male and female at the same time, so you can have monowiring simply by connecting two terminators to the speakers, and plugging the remaining pair to them! :-)

### Acoustic Results

The TNT tripleT finally finished!



Listening to these cables with an extremely revealing system, they sported a well extended and articulated bass range, a polite and never-invading midrange, cold-leaning mid frequencies, yet with rather good thickness, sharply glossy mid-highs, and very refined and accurate extreme highs. Their spatial reconstruction ability is simply very good (I'd say incredible, bearing in mind its cost), and is the real strong point of "TNT tripleT". There is a lot of air between the elements, which also sound stable and focused (here I experienced a relevant difference compared with the other cables I could test!). Their dynamic features are at very good level, too.

### In the End...

So, a pair of speaker cables that are rather strongly characterized with a dry and accurate musical attitude. Just those characteristics may even have a disturbing result if used with systems that are already characterized by a kind of coldness or an extreme mid-high range analytic ability, making music reproduction excessively aggressive.

Yet, I could use them with sure satisfaction with systems of different kinds: they only have to be not too brilliant. It's worth noting that, on more than one occasion, they gave detail and air to systems sporting flat sounds, but a little opaque (due to the synergy between their components, rather than the room characteristics); and that they magnificently integrated in an all-tube system featuring a high quality sound, yet with somewhat "old style" character.

In the end, if we consider that the basic stuff used surely has its own "acoustic limits" (the network UTP CAT 5 cable is indeed a cable designed to be rather cheap, and for non-audio purposes: no OFC copper, silver, teflon, esoteric fibers and so on...), I'd say that we can reasonably be satisfied with the results obtained. Yet, do not pretend to put them in your superbuck synergic audio system, and to hear it sound better than your mortgage-like gas-conductor high-end cables! :-)

That's all: ciao to everybody and wishes of a joyful time to all of you who dare to realize our "TNT tripleT"!!!

# Soli-Core

## Loudspeaker cable with a difference

### LOUDSPEAKER CABLE - SOLI-CORE:-

A revolutionary breakthrough in Hi Fi cable design, developed and tested to give your system a superior performance.

"Compared to the generic dumbbell (loudspeaker cable) it was ahead by a country mile, more open and far more dynamic, with none of the grain that characterises cheapo figure-of-eight cables."

TNT AUDIO Internet magazine - Feb 2000.

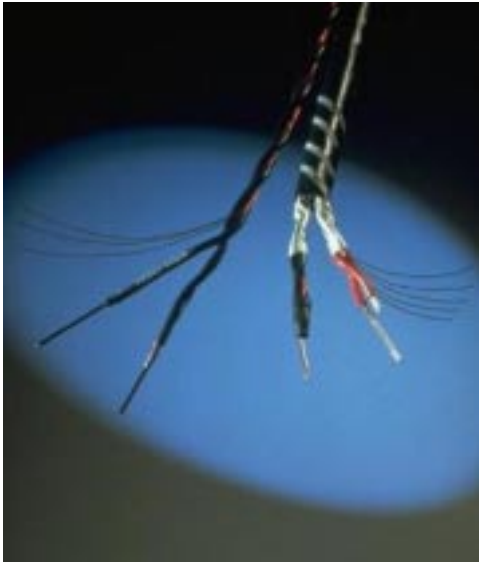

Ears and logic will both attest to the breathtaking performance of SOLI-CORE in its high quality transmission of audio signals. This loudspeaker cable is capable of making an extraordinary difference to your system. Sonic gains are made in all areas from bass extension to crystal clarity and presence in vocals and treble instruments. The overall sound takes on a greater integrity and coherence. Vocals remain controlled with reduced 'graininess'. The effect is highly dynamic, clean and crisp without being hard and edgy. In comparison, other cables can lack life and sound flat. Users also find one of the most enjoyable aspects is the very realistic and accurate "soundstage effect" brought about by the well known imaging and separation characteristics of solid core. These are just some of the improvements to be noticed. Many impressed users have declared that Soli-core is the most superior cable on the market by a considerable margin. Why not try it for yourself and you too could be enjoying the most superb music you've ever heard from your system.

## Soli-core loudspeaker cables - INTRODUCTION

SOLI-CORE's exceptional performance is based on unique and revolutionary developments. The result is a hi fi cable which outperforms other cables in a large number of systems (including other solid core designs and the specially developed stranded audiophile cables which use expensive manufacturing techniques). The performance is outstanding and yet the cost is within easy reach of anyone who wishes for a significant upgrade.

## Loudspeaker cable design - THE BACKGROUND

What makes a good loudspeaker cable? It has been discovered that high frequency signals are best transmitted through "thin" wires while "thick" wires are more effective in the transmission of low frequencies. In order to achieve the best of both worlds conventional audio cables use thin wire strands collectively bunched together to form a "thick" wire. The weakness of this method lies in the unavoidable creation of non-linearities within the cable. It is these non-linearities along with a number of other factors, which consequently degrade the signal passing through a cable. In the past some steps were taken to improve matters by audio cable manufacturers.

For example:

- (a) Large cross-sectional area of stranded copper.
- (b) High purity copper.
- (c) Oxygen-free copper.
- (d) Linear crystal structure in the copper (LC-OFC).
- (e) Special insulation of the conducting wires (PTFE etc.).
- (f) "Directionality" of the conductors.
- (g) Special low inductance winding of copper strands.
- (h) Pressure binding of the conductor strands to minimise minute vibration of the conductors.
- (i) Silver plating of conductors.
- (j) Litz cable (each strand is individually insulated).

However, while these factors generally improve stranded cable, notable weaknesses still remained. At first when the shift began away from heavily stranded cable to simple single strand solid core cable, there was a mixed response in the Hi-Fi world. Some extolled the virtues of solid core for its listenability. Others complained of less than satisfactory performance. This was probably due to one or more of the following reasons.

- (1) Observing that top and bottom end extension is detrimentally affected by conventional solid core cable.
- (2) Observing a loss in bass and midrange power over long cable lengths.
- (3) Not setting up each wire in its directional bias.
- (4) Noting that "thin" solid core seems lacking in good bass performance particularly when the volume is turned up or on inefficient speakers.
- (5) Using a cable with a poor impedance match for the system concerned.

## **THE PRODUCT**

Now a major breakthrough has been achieved! The shortcomings which existed in conventional solid core cable have been addressed and overcome. SOLI-CORE possesses all the virtues of solid core loudspeaker cable throughout the whole frequency range, and outperforms conventional stranded cable in every respect. To achieve this remarkable performance SOLI-CORE has a unique construction of thick solid core wires and thin wires (which inhibit the loss of higher frequencies). Each wire is individually insulated and the thin wires are not connected (PAT.P).

Additional features include:-

- (a) Capability to tune the cable to your system (You will need TWO lengths of wire for each speaker if you use this option).
- (b) Directionality set in the wire and labelled
- (c) Optimum winding configuration
- (d) Smart appearance
- (e) Wire diameters selected to within 0.05 mm dia
- (f) Hidden factors

SOLI-CORE is primarily a speaker cable but also makes an excellent interconnect cable.

## Genesis-Report

The once humble loudspeaker cable has seen a meteoric rise in importance in recent years. Previously at most an afterthought, cables are now crucial high-technology audio components in their own right, though often cloaked unnecessarily in mystery and intrigue.

There is now a vast choice of different cable types, designed to suit every need. Unfortunately, consumers are now confronted by a bewildering array of claims and counter-claims, turning what should be a straight forward purchase into something of a night mare! This situation is not helped by the mysticism and pseudo-science which is all too often used by some marketing departments .

This technical guide is a summary of in-depth scientifically-conducted research, with measurements and listening tests, carried out by QED into loudspeaker cable effects. Our aim was to develop new ranges of high-performance cables based on the results of these investigations and the current QED loudspeaker cables were developed as a direct result. Many lessons were learned, which have also influenced our interconnect cable design.

The listening sessions were vital: QED engineers are all too aware that measurements alone are not the whole story. It would be tempting to claim that they tell you everything, though this is clearly not the case. On the other hand, if any cable introduces measurable errors and distortions as a result of being inserted between the amplifier and loudspeaker, it obviously cannot reproduce music accurately.

QED believes cables should be as accurate, transparent and neutral as possible and it is with this credo that our cable development is undertaken, based on Genesis and guided by exhaustive listening evaluations.

### The cable's role

At first glance the role of loudspeaker cable would appear to be rather unglamorous, simply conveying the signal between amplifier and loudspeaker. In practice, though, differences in cable performance can readily be discerned by most listeners - though some diehards still deny even the possibility. Clearly there are factors in cable design and construction which influence sound quality.

Bearing in mind that no component can improve on the analogue signal passing through it (but can only change and degrade it) the ultimate role of any loudspeaker cable should clearly be to transfer the signal energy between amplifier and loudspeaker without loss.

### Basis of Assessment

Because loudspeaker cable is a link within a system, its assessment must be considered within the context of its two partners - the amplifier and loudspeaker.

The loudspeaker connecting cable is, in effect, an extension of the amplifier's circuit - equivalent to adding extra components to its output possessing the electrical properties of:

Resistance (R), Capacitance (C), Inductance (L) and Conductance (G).

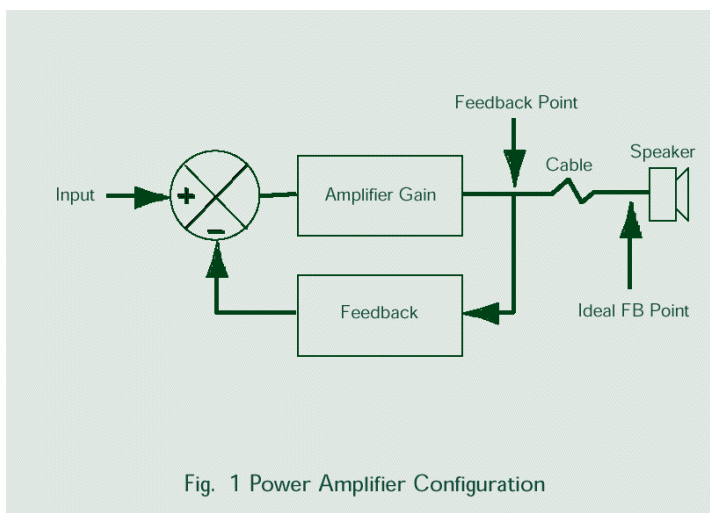

Fig. 1 Power Amplifier Configuration

Most power amplifiers are amplifying devices which achieve fidelity by comparing their output signal with their input. This is called 'negative feedback', or NFB. Any error appearing at the output of a NFB amplifier is effectively corrected by the amplifier automatically applying the opposite error at its own input. As can be seen from the diagram in Fig.1, an NFB amplifier can only attempt to correct errors that appear at the point of feedback. Errors at the loudspeaker input due to the influence of the cable remain uncorrected: the cable is beyond its jurisdiction.

Some NFB amplifiers have been designed to take their feedback from the loudspeaker terminals in an attempt to counteract cable effects, though this type of configuration is very rare. One objective assessment of a cables performance would therefore be to compare its input (at the amplifier output) to its output (at the loudspeaker input). Any difference amounts to degradation of the signal.

### Real Effects On System Performance

Terms used to describe the subjective effects of cables, range from positive ones such as; 'transparent', 'coherent', 'tight', 'detailed', and 'rhythmical', to negative comments such as 'grainy', 'loud', 'forward', 'twangy' and 'smeared' for example. Our Genesis research has shown that some of these can be explained by analysing electrical measurements. Cable samples representing a broad range of prices, technologies and marketing claims were tested, each sample measured driving a real loudspeaker load.

The two graphs shown in Fig.2 and Fig.3 are frequency responses. The upper trace was taken at the amplifier's output and the lower curve was measured 'after' the cable (at the loudspeaker's input terminals). There are clear differences in performance between the two cable types.

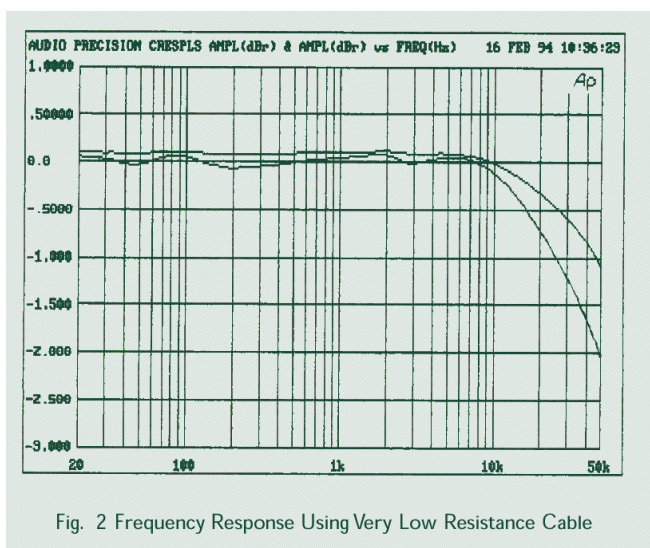

Fig. 2 Frequency Response Using Very Low Resistance Cable

The lower of the two curves in Fig.2 is for a very low loop resistance ribbon cable (sample 10 in our tests), while Fig.3 shows the effect of a dual-stranded solid-core cable (sample 7). The ripples in the curve are due to the variations in load impedance of the loudspeaker system within the audio bandwidth influencing the voltage 'dropped' across the cables impedance at different frequencies.

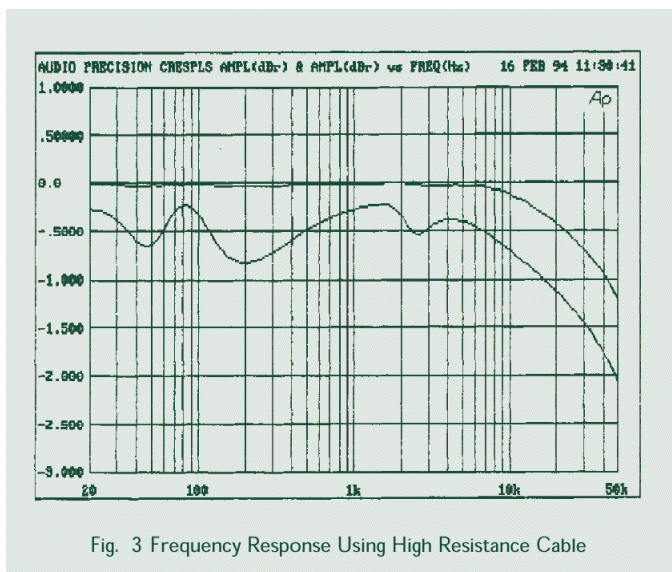

Fig. 3 Frequency Response Using High Resistance Cable

The loss in the cable is effectively the difference between the upper and lower curves in both Fig.2 and Fig.3. Clearly, there is a greater loss due to the solid core shown in Fig.3 due to its greater DC resistance. This is not merely academic, because the overall frequency response of the loudspeaker will be modified by these variations (amounting to as much as -0.8 dB at 200 Hz for Fig.3).

The resultant responses shown in both curves are typical of a bass reflex (ported) loudspeaker system using a steady-state sinuswave inputsignal. Real signals are non-sinusoidal (comprising many frequencies simultaneously) and the I ads presented by loudspeakers will be complex (complex meaning that current and voltage are not always exactly in step, or in phase). As a consequence, there will be a far greater dynamic amplitude loss across the cable when playing music than would at first be inferred by examining these steady-state curves.

Given this clear evidence that low resistance is necessary to ensure the flattest possible frequency response with real-world loudspeakers, it is surprising that there has been a trend away from low-resistance cables to higher resistance solid-core types.

One of the major reasons quoted in manufacturer's marketing materials has been the claimed reduction in skin effect obtained from the use of low-cross-sectional-area solid-core cables.

### Skin Effect

Skin effect is a phenomenon normally associated with high-frequency transmission lines. When an alternating current flows through a conductor, an electromotive force (EMF) is induced due to the changing magnetic flux within the conductor. This causes the current density to decrease at the centre of the conductor compared to that near the outer surface. In effect, the area through which current flows is reduced, with current diverted from the core. The result of skin effect is a rise in cable impedance at very high frequencies, due to the shrinking effective conducting area increasing the total impedance.

(Curiously, unlike inductance, skin effect does not introduce phase shift but does give rise to increased power loss in the cable).

In radio-frequency applications (way above the audio range) skin effect can be a serious problem, overcome by silver plating to reduce resistance at the surface, where the bulk of the high-frequency current flows. In audio cables, the assumption that skin effect is worth tackling has resulted in loudspeaker cables with single strands of diameter equal to or less than twice the effective signal penetration depth (the depth at which current density is reduced to 63% of its normal value) at some high audio frequency. The idea being that the cable will be operating at all frequencies in reduced-current-density mode. By doing so, the symptoms of skin effect are swamped (though it has not been beaten) while the overall impedance of the cable has been increased at all frequencies.

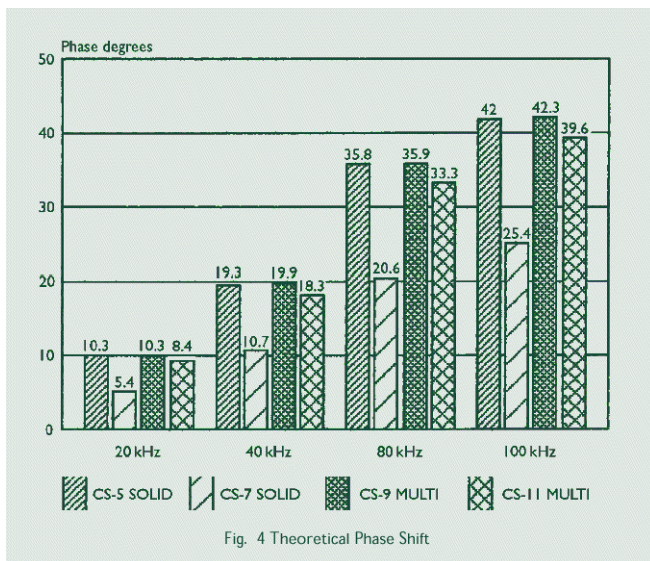

There has certainly been much debate about the audibility of 'skin effect', most engineers questioning its very presence at audio frequencies. To assess its magnitude objectively, we selected four loudspeaker cable samples for comparative measurements of high-frequency phase shift. Two of these were large-diameter multi-stranded cables and two were low-cross-sectional area 'low-skin-effect' types.

Initially, the basic characteristics of resistance, inductance, capacitance and conductance were measured (known as lumped parameters). These figures were then used to calculate a theoretical prediction of phase shift, when driving a load. It is important to remember that these theoretical figures did not take into account skin effect and were based purely on the lumped parameters.

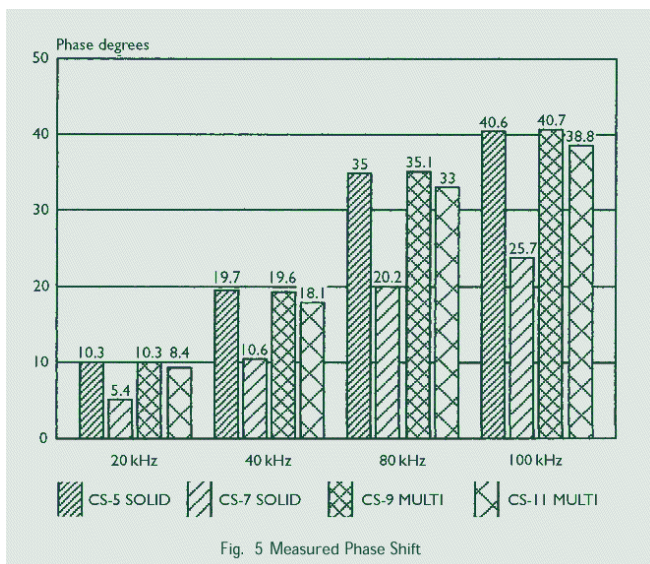

The results are shown in Fig.4.

Actual phase shifts into the same value load were then measured for each cable sample and the results are shown in Fig.5. Contrary to what one may expect if skin effect were significant, there is remarkably close correlation between the actual and predicted values.

Only above 80 kHz is there a significant deviation in the multi-stranded cables (if 2% at 100 kHz can be considered significant!).



The two phenomena contributing to these differences are skin effect and, possibly, proximity effect. The latter is an increase in current density on the inside faces of parallel conductors and is most acute for closely-spaced strips conductors. Interestingly, measured values of phase shift are generally lower than the theoretical predictions because skin effect, which is resistive in nature, increases the AC impedance of cable without introducing phase shift of its own. Curiously, skin effect actually reduces phase shift by countering the inductive reactance of the cable. (Those who wish to take this further are referred to text books on AC phasor theory ).

Note that cable sample 7 in Figs.4 and 5 exhibits lower phase shift than the others simply due to its lower inductance.

### Inductive Effects

The effects of inductive reactance on AC signal phase shift for a number of tested cables is shown in Figs.6 and 7. The higher the inductance, the greater its effect on phase shift. Examining the geometry of each cable sample revealed that the majority of the multi-stranded cables were inherently inductive.

The inductance of a cable depends on the area of the conductors, their relative spacing and the permeability constant of the surrounding media.

(High permeability materials, such as iron and ferrite are used to increase inductance, in wound inductors for instance.)

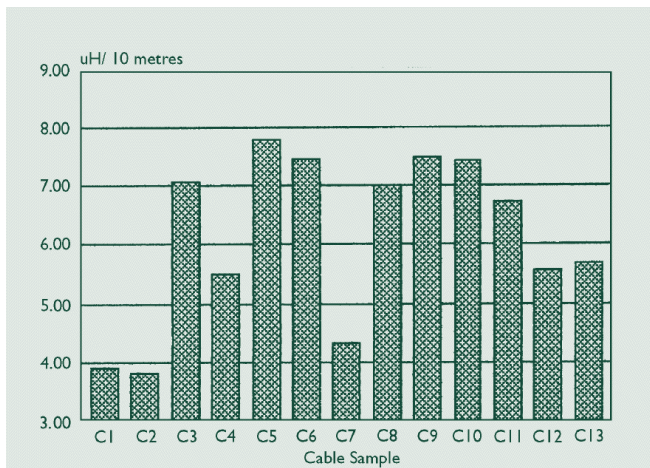

Fig. 6 Cable Loop Inductance

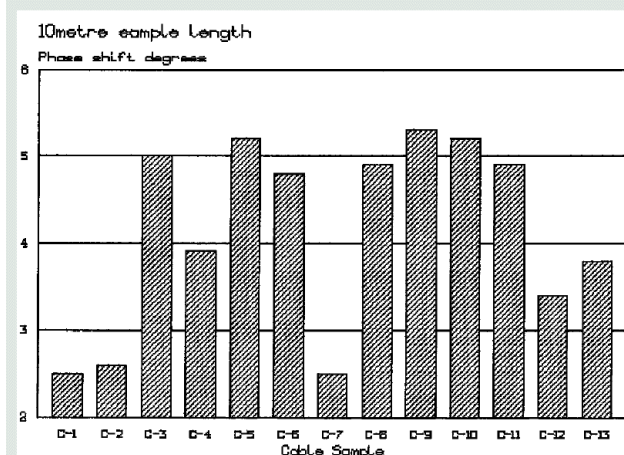

Fig. 7 Cable Induced Phase Shift at 20kHz

In cables, the wider the conductor spacing, the greater the inductance. Many of the multi stranded loudspeaker cables available feature conductors spaced widely, some more than three times the conductor diameters, resulting in higher values of inductance.

Averaging the inductive effect across our samples gave an effective phase shift of 0.42° per metre. So, for a 10 metre length, this would give 4.2° of phase shift. In practice, the cable inductance is in series with (in addition to) an output inductor in the amplifier ( built-in to improve the amplifier's high-frequency stability), so the overall amplifier inductance is effectively increased by the cable.

## Audibility of Phase Shift

At present, the absolute audibility of frequency - related phase shift is relatively unknown, although amplifiers that exhibit poor phase response are often criticised as being 'grainy'. Surprisingly, amplifier phase shift is rarely mentioned, yet it is not uncommon to measure in excess of  $15^\circ$  at 20 kHz in commercial designs.

## Peaking due to Inductance and Capacitance

Another effect of inductance is high-frequency amplitude loss, due to the increase in cable impedance at high frequencies (inductive reactance,  $X_L$  rises with frequency). So, as frequency rises, there is less signal remaining at the loudspeaker terminals. Interestingly, high cable inductance can also be responsible for a rise in the output in the voltage at the loudspeaker terminals due to the amplifier's output! This is caused by the complex interaction between inductive and capacitive reactances and resistance producing a damped resonance. This can be a problem with electrostatic loudspeakers, which represent a higher capacitance load than conventional moving-coil loudspeakers.

An example of resonant peaking is shown in Fig.8, shown with the raw amplifier output. Here the increased impedance of the cable at high frequencies produces a considerable loss of signal level when combined with the amplifier's own roll-off.

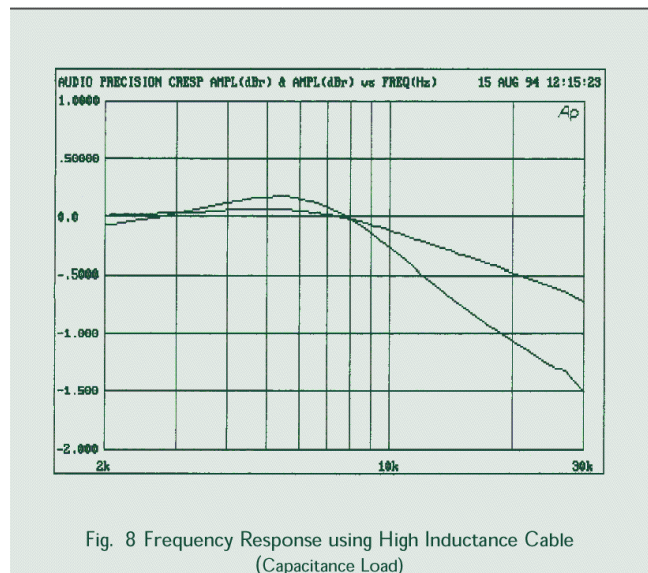

## Dielectrics

Loudspeaker cable conductors are sheathed with insulation, otherwise known as dielectric, to prevent shorting. This inevitably introduces additional losses because all dielectrics absorb some energy. The dielectric loss is sometimes referred to as the dissipation factor or  $\tan \delta$  (almost the same as Power Factor) and this increases with frequency. As a general guide, the higher the dissipation factor at a given frequency, the greater the power loss within the dielectric. A selection of dissipation measurements on samples from our cable selection is shown in Fig.9. It shows a surprisingly wide spread of results.

All dielectrics also possess a property known as permittivity.

The lowest permittivity dielectric, (apart from a vacuum), is air and this introduces the lowest loss of any practical material. The greater the permittivity, the greater the loss and also the higher the capacitance. This is because permittivity is a measure of how easily the dielectric 'permits' the establishment of the electric field, which is the very cause of the capacitive effect.

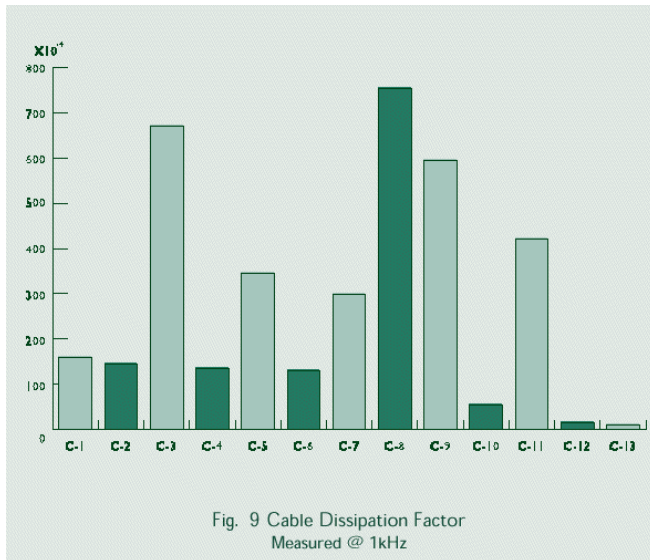

Conversely, the lower the permittivity (the closer to a vacuum) of a dielectric, the lower will be both the losses and capacitance. If a vacuum is taken as a reference of 1.0, this yields the Dielectric Constant  $\epsilon_r$  for any dielectric.

Air works out to 1.0006 which, to all practical intents and purposes, is virtually the same as a vacuum.

The Dielectric Constants ( $\epsilon_r$ ) and losses ( $\tan \delta$ ) for several popular speaker cable insulators are shown below:

Insulator	$\epsilon_r$	$\tan \delta$ approx at 10 kHz
PolyVinylChloride (PVC)	4.0-8.0	0.01 - 0.05
PolyEthylene (PE)	2.6	0.0002
PolyPropylene (PP)	2.25	0.0004
PolyTetraFlurothelene (PTFE)	2.1	0.002
Air (for reference)	1.0006	virtually 0
Vacuum (for reference)	1.0000	0

Capacitance is also governed by the spacing and diameter of the conductors. The greater the gap between any two conductors in a given dielectric, the lower the capacitance, (the reverse is true of inductance). A quick look at the table above should make it quite obvious that designing a cable with low inductance and capacitance is particularly difficult when poor-quality dielectrics are used.

The majority of lower-priced cables, and many in our sample, used PVC dielectrics, which cause inherently greater capacitance and dielectric losses. Whatever is done with the conductor spacing and diameter, such cables are at a distinct disadvantage, with either greater capacitance or inductance (or both).

## Cable Conductance

Another quality of the dielectric which affects cable performance and is tied in with dielectric loss is conductance (G). Conductance is a measure of how well two conductors are insulated from one another. The lower the conductance (G), the greater the insulation resistance (Rp). Higher quality dielectrics are inherently better insulators because there are fewer 'free' electrons to carry electric current within the material when a signal is applied.

## Effects of Capacitance

In theory at least, cable capacitance should have little effect on system performance, because the cable is driven by a very low source impedance, typically fractions of an Ohm for most power amplifiers.

Though the capacitance forms a low-pass filter when connected to this impedance, its effect on frequency response is typically minuscule. More insidiously, unduly high cable capacitance in a speaker cable may indicate poor dielectric quality and high dielectric losses.

Some esoteric cables employ a number of separately insulated paralleled wires to form the two conductors. With certain geometries and lower-grade materials, this can cause capacitance to rise to a high level. One such sample in our test group had a parallel capacitance of some 1375pF compared to the average sample capacitance of 500pF for a 10 metre length.

Another factor to be considered with speaker cables is amplifier stability. In some cases, a little extra capacitance at the output can make an amplifier oscillate, overheat and even self-destruct. Or it may oscillate momentarily at high radio frequencies during operation and show no obvious symptoms. Well-designed amplifiers normally have a good gain/phase margin, which ensures that small extra phase shifts due to increased capacitance do not cause such problems. Unfortunately, some commercial designs do not have sufficient gain/phase margins for unconditional stability and it is these which cause problems with long lengths of higher-capacitance cables. Ironically, inductance is likely to be lower for high-capacitance cables, leading to a further reduction in the stability margin. Even if not outwardly unstable, sound quality

can suffer, with harsh and forward-sounding results as the amplifier sits on the edge of instability.

Fig. 10 shows instability due to high capacitance cable as ringing on a 'fast' square wave signal.

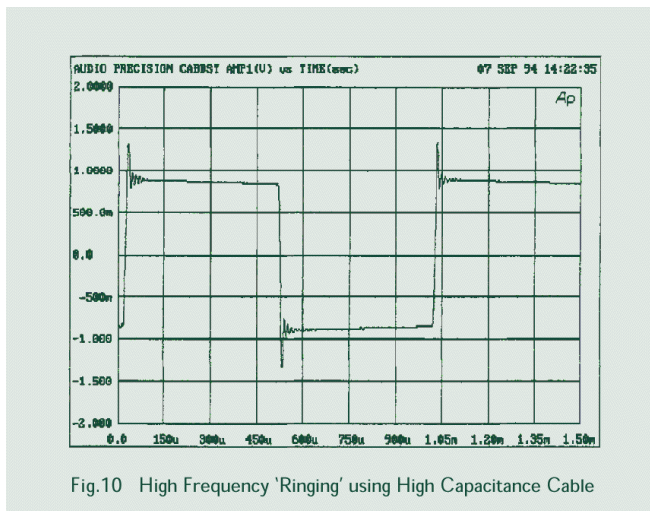

Fig.10 High Frequency 'Ringing' using High Capacitance Cable

## Capacitance versus inductance

With a single pair of conductors in a given dielectric, reducing their spacing reduces inductance and raises capacitance, while increasing their spacing has the opposite effect. Consequently it is often assumed that it is not possible to buck this trend and reduce inductance without increasing capacitance.

Indeed, it has almost become embedded in audio folk law. However, comparisons carried out between different conductor layouts, even with similar total conduct or cross-sectional area (and

hence similar DC resistance) showed that this is possible, even with the same dielectric material, simply by re arranging the conductors (see Table 1).

	Qudos	Profile 8 (inner/outer)	Profile 8 (left/right)
C(pF/m)	35.6	37.2	21.3
Loop L (µH/m)	0.55	0.39	0.54
Loop R (mOhms/m)	14.0	15.0	15.0
Zo(Ohms/m)	118.5	104.7	159.6

Table 1

These are the results of tests carried out on cables which came out of Genesis research and are shown to illustrate the profound effects of geometry. Resistance, inductance and capacitance were all measured with standard Qudos and Profile 8. Standard Qudos is two bunches of 79/0.2 in figure-of-eight layout. Profile 8 is eight bunches of

19/0.2 in flat layout. The crosssections and therefore DC resistances are about the same. LDPE insulation is used in both cases. Therefore any differences in inductance and capacitance are due to geometry.

Profile 8 can be configured in a number of ways. Table 1 shows results with the inner four and outer four used as a pair and also with the left four and right four used as a pair. Compared to standard Qudos, Profile 8 connected using inners and outsiders shows a significant reduction in inductance and actually slightly less capacitance, which is counter to the 'rule of thumb' often quoted.

Conversely, the left/right configuration gives similar inductance to Qudos but with capacitance almost halved. As a matter of interest, the geometry also affects the characteristic impedance as shown, though this is only of academic interest.

### Acoustic Crosstalk

One subjective effect often noticed by listeners is an increase in soundstage width when certain speaker cables are used. At first glance it is difficult to see how this could happen, considering the high electrical isolation between the stereo channels. We thought one explanation may be that acoustical coupling exists between left and right channels via the loudspeakers themselves. Ideally, the left speaker should vibrate only with left-channel signals and vice versa.

Each channel of the amplifier ideally applies electro-magnetic braking to its own loudspeaker preventing it from being moved by air waves from the other one. It should achieve this braking, or damping, due to its very low source resistance, but in practice the cables resistance intervenes, increasing the source resistance 'seen' by the speaker and reducing damping. So, each loudspeaker can vibrate in sympathy with the (delayed) output from the other, with subsequent narrowing of the sound stage. If this were true, low-resistance cables would give a wider sound stage.

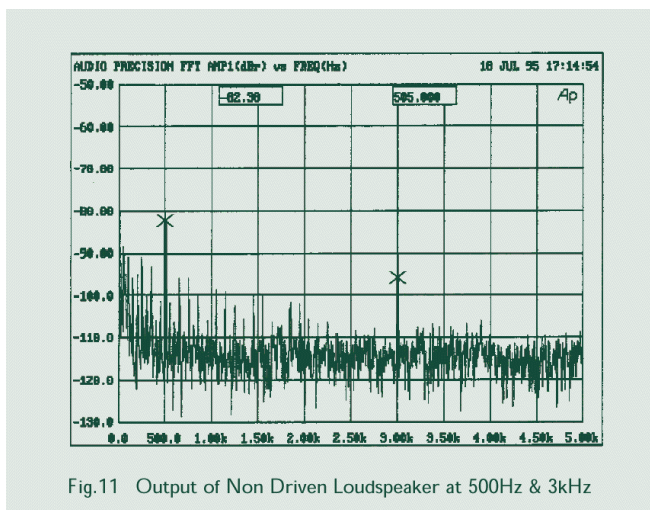

Fig.11 Output of Non Driven Loudspeaker at 500Hz & 3kHz

Though seemingly far-fetched, measurements of loudspeaker terminal voltages shown in Figs.11 and 12 show just this effect. The peaks marked with an 'X' are the amplitudes of signals generated by the movement of a non-driven loudspeaker's diaphragm in response to test tones fed to the other channel's loudspeaker.

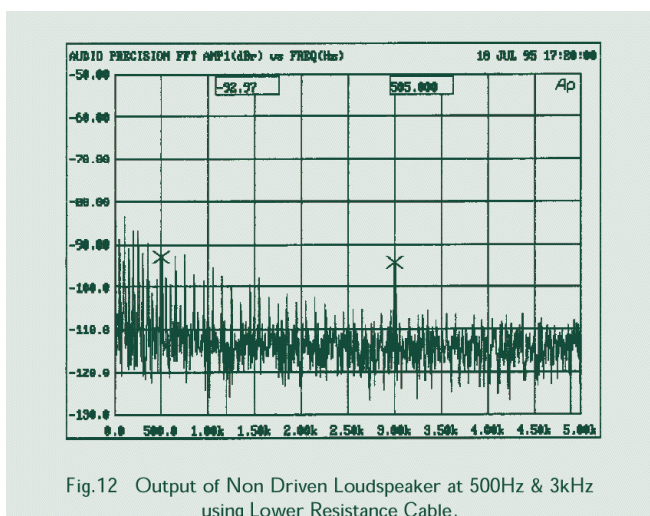

Fig.12 Output of Non Driven Loudspeaker at 500Hz & 3kHz using Lower Resistance Cable.

The 500 Hz terminal voltage is reduced by about 10 dB lower with the lower-resistance cable shown in Fig.12.

## Transient performance

As mentioned earlier, loudspeakers in general are very complex electrical loads which generate voltages (due to sound impinging from outside, and energy stored inside) which are fed back to the amplifier (also known as back EMF).

This can occur as discussed in the last section, or when subjected to a sudden change in signal amplitude, when the speaker will 'ring', producing an output when there is no input. The amount of ringing depends on the amplifier and cables combined ability to 'damp' and control the unwanted oscillation.

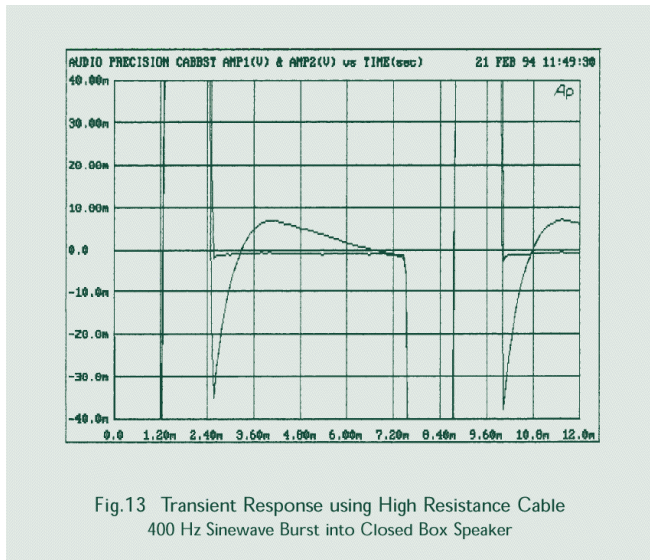

Clearly shown in Fig.13 is the amplifier's output and the voltage at the speaker terminals. At just after 2.4 ms, when the amplifier output drops to zero, the speaker voltage continues negatively, then rises and 'overshoots' positively before settling. This represents unwanted diaphragm movement.

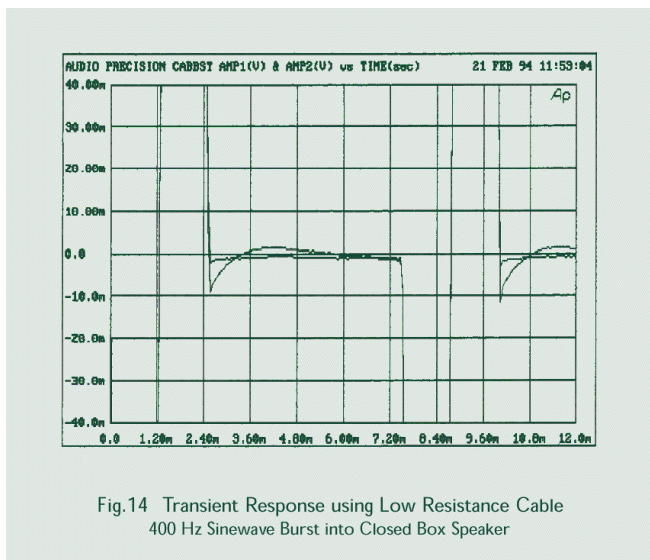

Shown in Fig.14 is the same loudspeaker with lower resistance cable: the measured improvement is clear.

Cable inductance also increases the overall impedance between amplifier and loudspeaker and our measurements showed this to have further harmful effects on transient performance. The loudspeaker's complex mechanical/electrical system works best it seems when damped by as low an impedance as possible, over the whole frequency range - not just at low frequencies where the cone movement is controlled by DC resistance.

## Cable-Induced Distortion

Loudspeaker cable electrically distances the speaker from the amplifier in several ways, with DC resistance spoiling frequency response, damping and separation as we discovered. In addition, measuring distortion at the loudspeaker input terminals showed figures significantly higher (particularly second harmonic) than at the amplifier output.

We found that the deterioration in quality (and fidelity to the original) depends largely on the cables DC resistance and loudspeaker type.

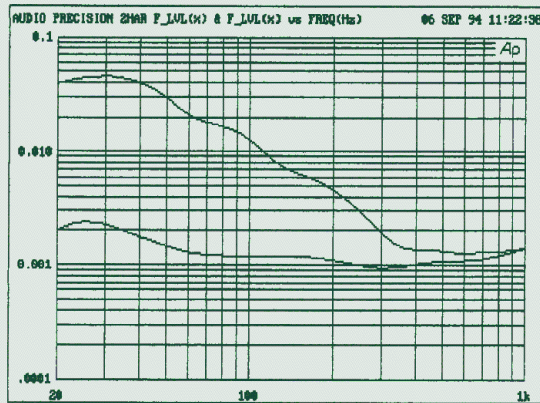

Fig.15 Low Frequency 2nd Harmonic Distortion  
(High Resistance)

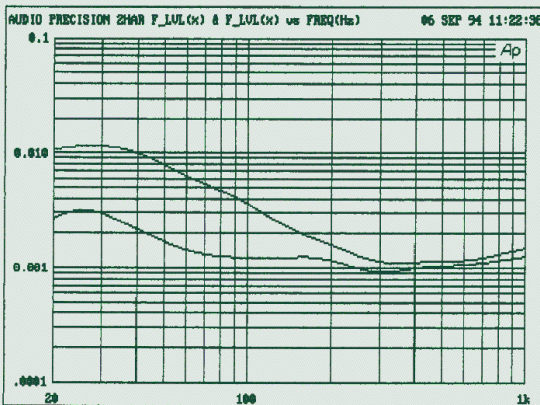

Fig.16 Low Frequency 2nd Harmonic Distortion  
(Low Resistance)

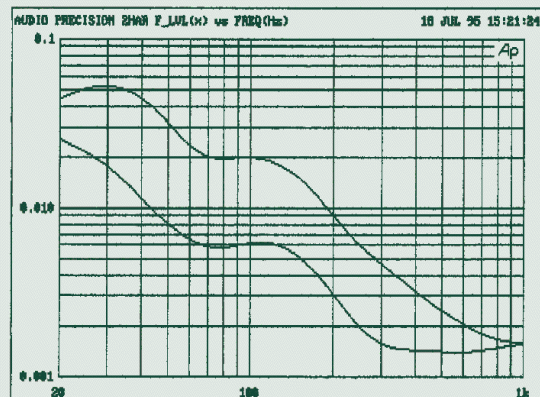

Fig.17 2nd Harmonic Analysis of Same Cable using  
Different Speakers

Shown in Figs.15 and 16 are plots of second harmonic against frequency. The top trace in each case shows the distortion at the loudspeaker, while the bottom traces show the amplifier's output. In Fig.15 (high resistance cable (0.065  $\Omega/m$ ), distortion is roughly three times that in Fig. 16 with low resistance (0.004  $\Omega/m$ ) cable.

In contrast, Fig.17 shows the effect of different loudspeaker loads with the same cable. Note, the cable does not it self cause distortion (its DC resistance is essentially linear), rather its presence prevents the amplifier's feedback from accurately correcting distortion generated by non-linearities within the speaker system.

Connecting the amplifier directly to the speaker showed distortion accurately corrected to within a small percentage of the amplifier's non-loaded condition. Further investigation is required, but it seems that distortion at low frequencies is influenced partly by the resonant frequency of the speaker enclosure. In addition, mid and high-frequency distortion figures were significantly worsened by increased cable inductance, which increases cable impedance and consequently reduces the damping effect of the amplifier and cable on the loudspeaker.

### Multi-strand vs. single core distortion

There is a view that multi-strand cables introduce 'diode' effects due to current jumping between strands within the cable and therefore crossing very many metal/oxide/metal junctions between strands as electrons travel from one end and the other. (This is sometimes said to be caused or worsened by 'skin effect' pushing the current towards the surface at high frequencies).

Making the assumption that the current does jump (there is no evidence for this but, as we found, skin effect would not seem to be a significant influence) we put signal in via one strand and measured the out come from a different strand.

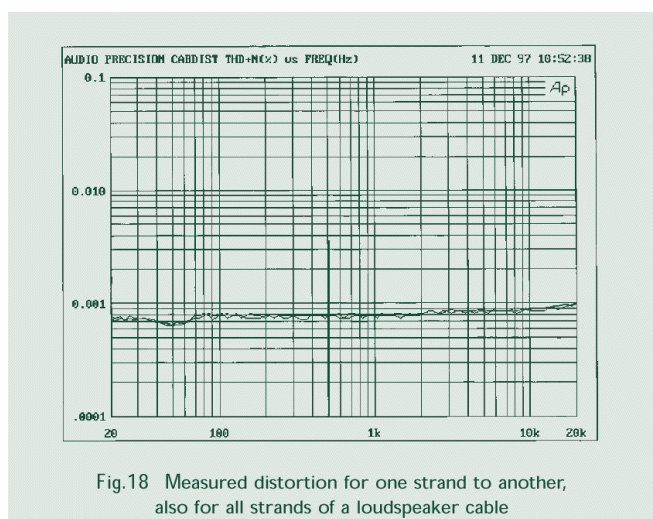

Fig.18 Measured distortion for one strand to another, also for all strands of a loudspeaker cable

Even using the Audio Precision AP1 down to the very lowest levels no increase in distortion compared to using all the strands could be found (see Fig.18). This shows both cases - so close that they could just as easily be repeat tests of the same measurement. In this instance it's a case of not proven. It seems inter-strand diodes do not exist, or if they do they are shorted out by the many good conductors pressed together over the cables length.

### Characteristic Impedance

This term is occasionally mentioned in connection with audio cables, although it is mainly associated with transmission lines. Characteristic impedance is crucial in determining the correct loading and source impedances for high-frequency transmission lines, to prevent the creation of unwanted reflections and standing waves. To work correctly, a transmissionline must be terminated at both ends by a resistive load equal to the characteristic impedance.

Loudspeaker cables are not transmission lines, because the longest are only a fraction of the wavelength of the highest audio frequency. In any case, even if they were, they cannot be terminated at both ends with the correct impedance (an 8 Ω source impedance would ruin damping while seriously compromising frequency response and distortion).

### Directionality

Measurements to test for cable asymmetry in the samples, some of which were directionally marked by their manufacturer, revealed little to suggest the existence of directionality. Blind listening tests also revealed that listeners were unable to discriminate a cables direction. The lay of the cable, on the other hand, was found to have a measurable influence on performance, so to be reliable, any listening or measurement tests would require identical cable positioning for each direction.

### Conclusions

Although there will always be those who remain sceptical about the importance of loudspeaker cables, the results of our research clearly indicate that system performance can be improved or degraded depending on the loudspeaker cable used. Analysing the compiled data revealed a fair degree of correlation between sound quality and measured performance.



The findings can be summarised as follows:

### 1. DC Resistance

Low cable resistance is of paramount importance if high sonic performance is to be attained, but this should not be achieved at the expense of other crucial parameters. High cable resistance results in several undesirable consequences: frequency response aberrations, impaired transient response, increased induced distortion and reduced inter-channel separation.

All cables exhibiting high resistance measured badly in these areas. Subjectively, their performance was highly dependent on the partnering loudspeakers. The forward midrange presented by these cables correlated closely with their subtly shaped frequency responses. High cable resistance also reduced dynamic impact with heavily scored music.

### 2. Inductance

Cable inductance is a prime cause of high-frequency attenuation and phase shift. Inductance causes impedance to rise with frequency, resulting in attenuation of the very upper frequency range at the speaker terminals and sometimes even peaking. In addition, inductance increases distortion at the loudspeaker terminals and degrades the loudspeaker's overall transient response. So, low inductance is required to achieve a flat frequency and phase characteristic, low distortion and good transient response from the loudspeakers.

### 3. Skin Effect

Skin effect is shown to be of minor significance when considering cables of moderate cross sectional area. Cables with larger conductors, although exhibiting greater skin effect, also tend to be more inductive, which causes greater high-frequency signal loss.

Only at frequencies well above the audio range does skin effect increase to a point where it could be considered significant. Though the percentage rise in AC impedance of a high cross-sectional area conductor will be greater than that of a low cross-sectional-area conductor, its effective AC impedance (and DC resistance) will still be lower. Skin effect also has the unexpected side effect of reducing the level of phase shift caused by cable inductance at high frequencies.

### 4. Insulation Quality

Dissipation factor proved to be a very strong indicator of sound quality. Most of the better sounding cables used superior dielectric materials: **PVC insulated cables gave the worst sound quality.** Cables which measured badly for dielectric loss appeared less able to reveal subtle detail, losing some of the atmosphere revealed by better cables with superior dielectrics.

### 5. Consistency of Performance

Loudspeaker cables interact both with amplifiers and loudspeakers. Consequently, some cables gave varied results in different systems. Those which performed most consistently were those with minimal inductance, capacitance and resistance. Unless an amplifier relies on inductance to maintain stability, keeping the speaker cables as short as practically possible optimises performance. High cable capacitance is best avoided, because it can result in amplifier instability, which can spoil sound quality and reduce amplifier reliability.

### 6. Directionality

Despite an increasing tendency for manufacturers to mark cables directionally, no evidence was found under controlled conditions to support the notion that speaker cables are directional. It was found, on the other hand, that merely laying a cable differently could affect the inductance and capacitance.

## 7. Solid Core vs. Stranded Cables

Recently, solid-core conductors have increased in popularity on the basis that, if made thin enough, the solid conductor will show less variation in loss at high and low frequencies than a thicker stranded conductor. Our findings suggest that it is more likely to be the insulation and geometry of many solid-core cables which are responsible for their generally higher performance than stranded conductors.

In any case, simply paralleling up conductors, whether solid or stranded, reduces inductance, which has a far greater influence than skin effect.

The stranded cables tested had higher inductance and leakage than many of their solid-core counterparts which generally used separately-insulated wires (giving lower inductance) with higher-quality dielectrics (giving lower leakage losses). No evidence was found to support the popular theory that stranded cables suffer from distortion due to diode effects between strands, so this seems to be something of a red herring.

## 8. Metallurgy

Electrical conductivity was slightly superior for cables utilising high purity copper (>99.99% pure).

Greater improvements to conductivity were found with silver-plated copper and pure silver conductors.

Generally, within this group of cables, the geometries and dielectric materials were more significant than conductor metallurgy in determining a cable's sonic performance.

### Genesis - the outcome

As summarised in (1,2,3, 4 and 5) the most accurate and consistent-sounding loudspeaker cable will have minimal DC resistance, inductance and capacitance combined with low dielectric losses. All our research findings confirm this simple conclusion. Conductors designed with small cross-sections are an attempt to avoid skin effect (which is not an issue anyway at audio frequencies) have higher DC resistance, with obvious harmful consequences.

Through Genesis, QED's engineers have bucked the over-simplified 'rule' relating inductance to capacitance. Capacitance and dielectric losses have been reduced by choosing a suitable high-quality insulation material (low-density Polyethylene). In addition, minimising the insulation wall thickness and designing narrow webs (consistent with mechanical integrity) the ratio of air to solid dielectric has been improved, thus further reducing capacitance and dielectric losses. By optimally orientating multiple parallel stranded conductors, QED has been able to reduce both inductance and capacitance below that predicted from a single pair of the same DC resistance.

The use of stranded conductors of good total cross section has kept DC resistance low. The result is a range of low-loss transparent-sounding loudspeaker cables of superior performance. The correlation between insulation and sound quality has also influenced the design of QED's interconnects, which use foamed LDPE to increase the air/solid dielectric ratio and maximise sound quality.

# Wireworld

## WIREWORLD CABLE TECHNOLOGY

Some cable distortions can be minimized by using superior materials. For that reason Wireworld cables utilize the finest materials available at each price level. However, the most audible cable distortion of all, electromagnetic interaction, is controlled by the design of the cable. The electromagnetic effects of cables filter and distort music signals. This distortion changes the harmonic structure of sounds, making some frequencies sound louder and others sound quieter. Electromagnetic interaction also has a great influence on imaging because it alters the leading edges of sounds; the delicate information that the ear/brain utilizes to locate sound sources.

The combination of matching interconnects and speaker cable can balance out the distortion to produce a relatively neutral and coherent sound. Other brands of audio cable work this way, however, the highest performance can only be achieved by having both interconnects and speaker cables as neutral as possible. Wireworld's patented Symmetricoax design minimizes electromagnetic interaction and all other types of distortion and noise so effectively that the cables sound nearly identical to a direct connection. Rewiring a system with Wireworld cables makes it possible to hear far more delicate sounds and to place instruments and voices in a vivid three-dimensional soundfield that sounds remarkably close to a live concert.

### The Symmetricoax Cable Design

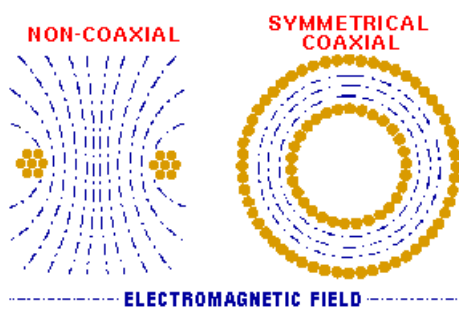

As this diagram illustrates, the concentric form of the Symmetricoax design is similar to a solar eclipse. To understand the superiority of this design, consider the fact that the strength of a magnetic field varies with distance. The Symmetricoax design focuses the electromagnetic field of the music signal precisely in the gap between the two tubular conductors. This distributes the energy more evenly than any other design, thus producing the least possible electromagnetic distortion. This is the only design which simultaneously minimizes resistance, inductance, capacitance, skin effect, mechanical instability, and external interference.

The exclusive Wireworld Symmetricoax design is protected by U.S. Patent #5,298,682.

### Grain Optimized Conductors

All copper and silver conductors contain imperfections called grain boundaries, which create distortion that varies with the direction of the signal flow. Realizing that none of the existing technologies have produced directionless conductors, we concentrated on utilizing the best of these technologies to produce conductors that sound nearly perfect in one direction only. The result was our development of Grain Optimized conductors, a unique technology that controls both the size and the shape of the individual conductor grains to minimize their distortion of music. When used in the correct direction (according the printing on the cables) these ultra high-purity copper and solid silver conductors have the least audible distortion of any conductors we know of. In the opposite direction they sound diffused and less pure; similar to most other high purity/large grain conductors.

### Superior Stability

Within a cable, conductor movement caused by external vibration and the electromagnetic force of the music signal can produce distortion by varying the electrical relationships and by causing inconsistent contact between strands. Wireworld cables are exceptionally stable, constrained-layer constructions which minimize this insidious source of distortion. Furthermore, most of our cables utilize polymer coated strands to eliminate inconsistent contact between strands and the usual long-term degradation due to surface corrosion. The most obvious benefit of Wireworld cables superior stability is that individual sounds remain distinct, even in the most complex passages.

## The Finest Dielectrics

The dielectric (insulation) between cable conductors absorbs and releases energy, thus distorting the signal. To minimize such absorption, Wireworld cables utilize the best dielectric materials available in each price range. For example, the dielectric in Solstice III interconnect cable is solid Teflon, a superior insulator normally found in far more expensive cables. The advantage of Teflon in cables is the same as in cookware, the music doesn't stick to it! The ultimate cable dielectric is Microporous Teflon, which combines the advantages of Teflon, the best solid insulator, with something even better, air. The benefits of these superior materials include greater clarity and smoothness in the mid to high frequency range.

## Extraordinary Connectors

Standard audio connectors are made of brass and plated with nickel covered by a thin flash-plating of gold or rhodium to resist corrosion. Brass and nickel are rather poor conductors compared to copper and silver. Wireworld connectors are made of the most conductive metals; gold over copper for the intermediate models, and solid silver for the upper line models. Copper is rarely used for RCA plugs because it is far more difficult and expensive to utilize than brass. One reason for this is that both copper and silver have little or no spring action of their own. The Wireworld Globegrip RCA plug design solves this problem elegantly by utilizing a rubber O-ring to provide superior contact tension and wiping action. This innovative design is covered by U.S. patent #5,413,503 & DES #339,568. Wireworld's exclusive solid silver RCA plugs and spade lugs are the ultimate audio connectors. These elegant parts provide the cleanest and most vivid sound quality of any audio connectors in the world.

## Discrete Biwiring

Many speakers have separate high and low range inputs for biwiring, the use of separate wires for each range. Biwiring improves fidelity by reducing interaction between amplifier, cable, and speaker. Since the primary cause of cable distortion is electromagnetic interaction, the only way to achieve the full benefit of biwiring is to isolate the magnetic fields of the high and low range conductors. The following biwiring options are available to consumers.

Internal Biwiring, utilizing a single cable with four conductor paths, mixes the electromagnetic fields of the high and low frequency leads. Internal biwiring is popular simply because it is neater and cheaper than using two separate pairs of cable. A few manufacturers offer cables with different types of conductors or filters for high and low ranges. This concept actually changes the function of the crossover network in the speaker.

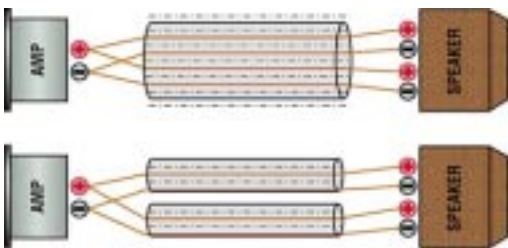

If the speaker sounds neutral and coherent with two identical conductor paths, the fidelity will be distorted by the differences in the two conductor paths.

External Biwiring, utilizing two non-coaxial cables which may be joined together at the amplifier end, provides better isolation than internal biwiring, but it also increases the likelihood of audible distortion due to vibrational movement between the two cables.

Discrete Biwiring is the only configuration providing the full benefits of biwiring. Wireworld Discrete Biwire speaker cables utilize two Symmetricoaxes to provide complete isolation between high and low range paths for higher fidelity than any other biwiring method. Discrete Biwiring provides the highest level of purity and spatial separation.

## Reaping The Rewards

The benefits of Wireworld cables are simply amazing. They often surprise even the most experienced audiophile with unexpected improvements in clarity, smoothness and three-dimensionality. Since they are the most neutral, they also have the widest compatibility of any cables. When used throughout a system, they consistently reveal the delightful essence of music.

The unique advantages of Wireworld cables have earned worldwide acclaim. The quotes in this guide are typical of the enthusiastic endorsements offered by high end component manufacturers, knowledgeable consumers, and respected audio critics. Wireworld cables advance the art and science of music reproduction to provide the ultimate value to music lovers, home theater enthusiasts, and music industry professionals.

## THE VALUE OF NEUTRAL CABLES

### A Technical Discussion

Neutrality is essential to lifelike music reproduction because the highest fidelity can only be achieved by minimizing audible changes through each link in the audio chain. These changes, commonly known as colorations, are actually distortions that lower fidelity because they filter delicate musical information and cannot be completely corrected by other links in the chain. Identifying the audible distortions of most components is difficult because it is impossible to compare them to a perfect component. However, cable distortions are much easier to identify, since cables can be compared to a perfect cable, a direct connection.

The upgrade audio cable industry exists because people realized that conventional cables are not neutral. They realized this by observing that changing cables alters the character of the sound, especially the presentation of quiet musical information. Unfortunately, simply comparing one cable to another does not tell us what either cable is doing to the sound. This fact is proven by the widely varying opinions on the sound of popular cables. Of the many cables described as neutral by reviewers, few actually sound close to neutral under objective test conditions. However, when cables are compared to a direct connection, such as the bypass in the Cable Comparator System, the descriptions of their sound quality are far more consistent, accurate, and useful.

Most of the differences we hear between cables are due to electromagnetic effects (skin effect, proximity effect, inductance). These effects cause time-related distortions that tend to sound like frequency response errors. As with other cable distortions, their audibility decreases as cables are shortened. The most surprising aspect of these effects is the way they can interact within a system. While the colorations of cables are often used to compensate for the colorations of audio components, the colorations of the various cables within a system tend to interact with one another to an even greater extent. In fact, many cables sound more neutral and coherent when their coloration is offset by a cable with an overlapping coloration than when they are used with an extremely neutral cable (or a bypass). That is why interconnects and speaker cables which are designed together tend to produce the most neutral and coherent result when they are used together.

Of course, the most lifelike music reproduction is achieved when both the cables and components are extremely neutral, however, most cables have substantial colorations. The majority of speaker cables have audible bumps in the lower treble and upper bass range. These colorations tend to stand out unless they are offset by interconnects that balance them out, or the cables are very short. Only the most neutral speaker cables we have tested allow all of the advantages of an interconnect bypass to be appreciated. The most neutral interconnects must also be used with neutral (or very short) speaker cables to fully realize their benefits. From this we conclude, that in the real world of cable and component limitations, the highest value is obtained by selecting components for their neutrality and compatibility, and connecting them with the most neutral cables available in the appropriate price range for the system.

The conventional swap-and-listen method of testing cables has limited the accuracy of cable reviewing and thus undermined the quest for higher fidelity. Furthermore, the lack of objective proof of cable performance and value has undermined the audio industry in general. Many people, including some noted experts, still believe that the concept of higher fidelity audio cables is a farce, and that those who believe in or profit from them are either dishonest or incompetent. This anti-cable position has been reinforced the fact that some "upgrade cables" have little or no real benefit, and that the listening tests conducted by the Audio Engineering Society failed to prove that cable differences are audible under double-blind test conditions.

We are addressing these issues by facilitating and promoting high quality double-blind bypass testing and demonstration of cables. After years of rigging makeshift bypass tests to design cables I developed a device for making double-blind cable bypass tests. In 1995 we introduced The Interconnect Comparator which produced the world's first objective proof of the audibility and value of upgrade audio cables. The Cable Comparator System, the second generation of this concept, is a double-blind bypass testing system for both interconnects and speaker cables. It requires the use of a high-quality music source (i.e., a CD player), a pair of mono amps (or two identical stereo amps), and a pair of loudspeakers. The other requirement for identifying the often subtle differences in cables is a very quiet, acoustically clean, listening room. Under these conditions, the Cable Comparator System enables most listeners to reliably identify cable differences. We are making Cable Comparator Systems available to audio reviewers, retailers, consumers, and the AES.

## **FREQUENTLY ASKED QUESTIONS**

### **What makes Gold Eclipse better than Silver Eclipse?**

Gold Eclipse III interconnects and speaker cables are larger versions of the Silver Eclipse III cables. Gold Eclipse III speaker cable consists of two of the Silver Eclipse coaxes to provide either Discrete Biwiring or lower resistance. Gold Eclipse III interconnects larger size improves the ground stability of the system and allows for the finest tuning of the electrical effects. These advantages result in wider dynamics, more extended bandwidth, larger soundstage, and higher resolution than any other cables in the world.

### **When will the Comparator System be available for purchase and when will reviewers begin using the system for cable surveys?**

NOW! What are you waiting for? Several reviewers are now in progress!

### **What makes Silver Eclipse better than Eclipse?**

Silver Eclipse III interconnects and speaker cables are smaller versions of the Gold Eclipse designs. Their superiority over the standard Eclipse III series is due to the greater resolution provided by their solid silver conductors and RCA plugs. Silver Eclipse III speaker cable is actually identical to Gold Eclipse III except for having a single coax in place of the two coaxes utilized in Gold Eclipse III. The Silver Eclipse III cables have absolutely stunning sound quality, second only to the Gold Eclipse at about half the price.

### **Why do some audiophiles feel that copper is preferable to silver in audio cables?**

Silver conductors are capable of producing higher resolution than copper conductors and therefore tend to magnify whatever is wrong in the design of the cable. The superiority of solid silver conductors is proven by the fact that the solid silver Wireworld cables sound closer to a bypass than the copper models of the same design.

### **Why do some component manufacturers recommend low-capacitance cables?**

Capacitance is the tendency to store an electrical charge. Component manufacturers tend to focus on capacitance simply because they know that it can distort and filter audio signals. What they don't know is that another cable effect, inductance (electromagnetic interaction) plays a much greater role in the sound of cables. Since both effects are controlled by the spacing between positive and negative conductors, and neither can be minimized without maximizing the other, capacitance and inductance must be carefully balanced to avoid audible distortion.

### **What makes Eclipse better than Polaris?**

Eclipse III interconnects and speaker cables are larger versions of the Polaris III cables. They are actually the same design utilized in the Gold Eclipse III cables with the only difference being the use of copper for the conductors. Eclipse III speaker cable consists of two of the Polaris coaxes to provide either Discrete Biwiring or lower resistance. Eclipse III interconnects are larger than Polaris, providing finer tolerances and improved ground stability. The sonic benefits of these advantages include superior imaging and wider bandwidth.

### **Are there really any audible differences in RCA plugs?**

The sonic differences in RCA plugs are usually less audible than the differences in cables, however they can be a very significant part of the overall sound quality of a system. Loose connections can cause all kinds of problems, including equipment failure. The critical issues in connectors include the following: Fit, finish, contact area, pressure, dielectric effects, and the conducting properties of the metals and plating.

### **Is there an industry standard that cable manufacturers use to test their cables?**

There is very little, if any, standardization of testing procedures or specifications for audio cables. The basic electrical specifications of resistance and capacitance that most manufacturers provide do not describe the sound quality of a cable, nor do they define its suitability for a given application. Wireworld's promotion of bypass testing is really the first step toward any type of testing standard that defines the performance of cables. The only specification we know of that is useful to describe the sonic character and predict the compatibility of cables is the Inductive Transition Frequency.

**What makes Polaris better than Equinox?**

Polaris III interconnects and speaker cables have several advantages over the Equinox cables. Polaris III Interconnects are larger than Equinox, and therefore provide lower resistance and finer tolerances. They also have our state-of-the-art Globegrip gold/copper RCA plugs for superior connections. Polaris III speaker cable is actually half of the Eclipse III design which utilizes Microporous Teflon for cleaner transient response than the polypropylene foam in Equinox allows. The Polaris III cables sound more vivid and refined than the Equinox III cables, allowing even quieter musical details to be heard.

**Why are upgrade cables so expensive?**

The value in upgrade cables lies in their ability to improve fidelity by reducing audible distortion. The solutions to the problem of audio cable distortion vary tremendously in both their effectiveness and their cost. As with other audio components, a higher price tag does not ensure higher fidelity.

**Why is the dielectric material so important?**

The insulation between a cable's conductors (it's dielectric) tends to absorb portions of the signal and release the energy afterward, distorting musical transients. This effect is most noticeable as roughness in the higher frequencies.

**Do speaker cable manufacturers use upgrade cable in their speakers? If not, then isn't using and upgrade cable before the speaker a waste or less effective?**

Some speaker manufacturers use upgrade cable inside their products, but most do not. There are no perfect links in the HiFi chain, yet improving any one link almost always improves the sound quality.

**What makes Equinox better than Atlantis?**

Equinox III interconnects and speaker cables are actually scaled-down versions of the world-renowned Eclipse designs. Equinox III interconnect is larger than Atlantis interconnect, providing finer tolerances and lower resistance for improved ground stability. In addition to having lower resistance, Equinox III speaker cable has finer strands than Atlantis speaker cable for lower distortion due to skin effect. Overall, Equinox III cables sound smoother, more detailed and more dynamic than the Atlantis series.

**What do Wireworld Cables have Tubular Conductors?**

To avoid the electromagnetic distortions caused by "skin effect" and "proximity effect", audio conductors must be thin and have uniform spacing between positive and negative. The best solution to these requirements is to have one tubular conductor inside the other.

**What is Skin Effect?**

Skin Effect is the tendency of high frequencies to be concentrated on the surface of a solid wire or bundle of strands, while lower frequencies are conducted equally throughout the wire.

**What is Proximity Effect?**

Proximity Effect is the tendency of the high frequencies to be conducted through the portion of a cables conductors which are closest to the opposite polarity conductors. Proximity Effect, like Skin Effect, is caused by the continuously varying electromagnetic field generated by the music signal. The results of Proximity Effect are not only a loss of high frequencies, but a harshness that is fatiguing and makes it hard to hear the real sound of an instrument. Wireworld cables avoid Proximity Effect and Skin Effect because of their Symmetricoax design. This patented design allows the positive and negative single layer of strands (conductors) to maintain nearly equal and constant spacing from each other.

**What makes Atlantis better than Oasis?**

Atlantis interconnects and speaker cables are the least expensive Wireworld cables that have Polymer-coated strands. This coating prevents surface corrosion and intermittent contact between strands. The sonic advantages of Atlantis over Oasis include cleaner, more extended highs and greater clarity across the entire musical range.

### **What happens when Wireworld cables are combined with other brands?**

In most high quality systems the best results are achieved by using neutral cables throughout the entire system. It is important to remember:

1) Speaker cables often have more coloration than the electronics in the system.

2) Interconnects and speaker cables from most manufacturers have colorations that "balance out" when used together.

Replacing one or two of these cables with a very neutral cable like Wireworld's could result in the coloration of the remaining original cable(s) becoming even more noticeable. (see "The Value of Neutral Cables" )

### **Are Wireworld cables better on solid state or tube electronics?**

All Wireworld cables are designed to sound extremely close to a direct connection. Since their sound is the cleanest and most neutral, Wireworld cables complement both solid state and tube electronics equally.

### **What makes Oasis better than Solstice?**

Oasis III interconnects are a larger version of the same design utilized in the Solstice III interconnect, providing finer tolerances and lower resistance for improved ground stability. Oasis III speaker cable contains two of the Solstice II coaxes, providing the capability for Discrete Biwiring or cutting resistance by half. These advantages improve dynamic range and three-dimensional imaging.

### **What is "Discrete Biwiring"?**

Many speakers have separate high and low range inputs to improve fidelity by reducing interaction between amplifier, cable, and speaker. Since the primary cause of cable distortion is electromagnetic interaction, the only way to achieve the full benefit of biwiring is to isolate the two signal paths. WIREWORLD Discrete Biwire speaker cables utilize two Symmetricoaxes for complete isolation between high and low range paths to improve purity and spatial separation.

### **What makes Solstice better than Orbit?**

Solstice III interconnects have finer strands than Orbit Interconnect as well as a solid Teflon dielectric. The finer strands reduce distortion from skin effect, while the Teflon reduces distortion from dielectric absorption. These advantages improve purity and clarity in the midrange and treble. Solstice III speaker cable is simply a larger version of the Orbit speaker cable which improves bass extension and dynamic contrast.

### **What is wrong with conventional cables that make them distort the sound?**

The most audible problem in cable is electromagnetic interaction. Other causes of audible distortions include: Dielectric absorption, connector quality, conductor purity, grain structure, and mechanical instability.

### **What are the advantages of using balanced Cables vs. unbalanced cables?**

Balanced cables are less susceptible to picking up noise. Specifically radio frequency (RFI) interference and AC hum, which can add a layer of noise across the entire audible spectrum. As with any other technical feature, it is the quality of the component that makes the greatest difference... as opposed to balanced vs. unbalanced cables.

### **What make Orbit and Luna better than all other budget cables?**

Orbit and Luna are the least expensive Symmetricoax cables in the world. These budget cables deliver the benefits of the same technology used in the Gold Eclipse at a fraction of the cost.

### **Are there audible differences between spade and banana connections?**

There are three issues that effect the sound quality of a connection.

- 1) The surface area of the connection.
- 2) The amount of pressure that is being applied.
- 3) The quality of metals being used.

Generally speaking, spade lugs tend to be superior to banana plugs in regards to pressure and contact area. In most cases they are also better than banana plugs reference to the metals because they tend to be made out of copper as opposed to brass which is commonly used in banana plugs. Note: Wireworld's proprietary upgrade banana plugs features a 24K gold over copper probe and a polymer-spring to ensure excellent contact over the entire surface area. These Wireworld copper banana plugs are comparable in sound quality to a spade lug.



**What are those boxes on other brands of cable and why doesn't WIREWORLD use them?**

The boxes contain filter networks which are said to reduce the audible distortion of the cable by controlling time domain errors, signal reflections and noise. One limitation of this approach is that networks attempt to control these problems from a single point along the length of the cable. Wireworld cables do not use networks because our Symmetricoax design minimizes these distortions more effectively by controlling the signal flow along the entire length of the cable. The proof of the superiority of this approach is that Wireworld cables sound much closer to the ultimate purity of a direct connection.

**Aren't all high end cables designed to sound like a direct connection?**

While this is clearly the goal of high end cables, most are simply designed to satisfy the designer under his own listening conditions.

**Some manufacturers use screen mesh on the outside of their cables; others use a textile or fiber looking material and some use plastic. Does the outside material affect the sound or is it purely cosmetic?**

In most cases the outer material is purely cosmetic. There are some effects that may be influenced by the choice of materials surrounding the conductors, but these tend to be minor effects when compared to the obvious effects of electromagnetic interaction.

**What are you referring to when you talk about passing the "whole signal" and nothing but the signal?**

When passing "signal" or the "audio spectrum" through a wire or cable, the bass frequencies have a tendency to sound loose and uneven, while the lower high frequencies tend to sound bright. With basic cable this sounds like a "loudness button" coupled with phase problems. This obviously affects clarity, imaging, listening fatigue, and the ability to follow the music. Every design component that makes up Wireworld's technology, such as Symmetricoax, Grain Optimization, Polymer Coatings, Single Layered Strands etc. are used to avoid the natural problems in cable. Our goal is to pass the whole signal without noise perfectly balanced and deliver it all at the same time. Every Wireworld cable design is subjected to a series of bypass tests on the cable Comparator System. This is the only way to ensure that the cable is not acting like a filter. When a cable sounds close to a direct connection, we refer to it as sounding neutral.

**Is it better to have long speaker cables and short interconnects or short speaker cables and long interconnects?**

Wireworld cables are able to produce excellent results using either method because both Wireworld interconnects and speaker cable can maintain signal quality over long distances. However, if we had to pick an ultimate winner under conditions where the component driving the interconnect has strong drive capabilities, it would be the long interconnect.

**Why use Solid Silver RCA Plugs?**

Solid silver is the ultimate audio conductor. It provides distinctly cleaner sound and higher resolution than any other material. Wireworld is the only cable manufacturer to offer solid silver RCA plugs. They are extremely difficult and expensive to produce, but their amazing sound quality proves the value of Wireworld's commitment to produce the best in the world.

**Is it possible to define the sound quality of a cable by swapping it with another?**

Changing cables only tells you the difference in sound between the cables, it does not define the audible distortion caused by the cables. The only accurate way to define the sound quality of a cable is to compare it to a direct connection.

**Isn't it true that the value of special cables has never been proven?**

The original Wireworld Interconnect Comparator provided the world's first double-blind proof of value for upgrade cables.

**How much should I spend on cables?**

We have found that spending 10% to 15% of the total system budget on Wireworld cables tends to provide the highest sound quality per dollar. On the other hand, spending as little as half as much on the cables can still work out very well, since Wireworld cables perform far beyond their price range. The upper end of this cost range is usually appropriate where the cable lengths are unusually long, or the components have unusually high performance per dollar.

### **Wireworld manufacturers several different types of cables designed for Digital Audio and Video, what are the differences between them?**

Wireworld's Digital Audio Cables and Video Cables feature single layer Grain Optimized tubular conductors, very similar to those in the audio cables. Like the audio series, each type of Digital Audio and Video Cable is available in your choice of price range, length and termination options to meet your system requirements. Digital Audio Cables (both 75  $\Omega$  SPDIF and AES/EBU 110  $\Omega$  balanced) are designed to exceed the impedance and bandwidth requirements of Digital Audio signals. They are the ultimate choice for CD players, DVD players, digital signal processors, and D/A converters. Composite Video Cables (75  $\Omega$ ) are used between video source components, such as LaserDisc players and VCR's to carry the entire picture signal to the monitor.

S-Video Cables are two 75  $\Omega$  cables within one PVC jacket. The picture is divided into two signals, "Y" for the black and white signal and "C" for the color information. Each is then routed through it's appropriate internal coax. S-Video cables are commonly used with DVD and Laser Disc players, DSS receivers, Camcorders, and Super VHS VCRs.

Component Video Cables, used with DVD players, are three separate 75  $\Omega$  cables. This is the connection system used in professional studios.

RGB Cables (Red, Green and Blue) carry the three color signals plus vertical and horizontal information used with high definition projection television.

Audio Video Combo Cables are made up of one 75  $\Omega$  video cable and two (one pair) of audio interconnect cables. The perfect choice for video players including: DVD, Laser Disc, DSS and VCR dubbing and player to monitor connections.

### **Why does Wireworld use silver-plated copper strands on some of it's products?**

Silver is a better conductor than copper and is also less prone to problems from both surface and intra-grain corrosion.

### **Why do some Wireworld video cables use foil shields?**

Wireworld video cables utilize foil shields over their spiral conductor shields to improve noise rejection. This unique type of double shield configuration provides comparable noise levels and better visual performance than conventional quad shield designs.

### **Why does the overall diameter of a cable vary substantially between two manufacturers when both cables cost the same and the gauge is about the same?**

There are all different kinds of solutions that have been proposed to solve the problems in cable. In some cases the size is justified by the design approach, and in others it's merely an attempt to make the cable look more substantial.

### **Why are all cables directional?**

Grain structure effects cause cables to sound different in both directions. Most manufacturers have not taken advantage of cable directionality because they haven't found ways to control it. The grain optimization utilized in Wireworld cables specifically controls the grain structure of the metal to produce the lowest distortion when it's used in the proper direction.

### **What is Bypass Optimized?**

All high-end audio cable manufacturers strive to create distortionless cables, but the Comparator System has enabled Wireworld to produce cables that preserve more musical information with less distortion than any other cables in the world.

### **What is grain optimization?**

The metal conductors in cables are made up of individual grains. These grains are formed in a directional pattern which distorts music signals differently in each direction. Grain Optimization is Wireworld's special process which maximizes the size and controls the shape of the individual grains to provide the lowest possible distortion in one direction.

### **How can upgrade power cords make a difference when the current has already traveled through miles of cable?**

Many of the sonic problems we hear in audio components are caused by power line noise coming through the power supplies. This noise is made worse by another problem which is the resonance that occurs between the components transformer and the power lines. The results are often fuzzy and indistinct high frequencies and soft, loose bass. Wireworld power cords solve this problem by producing very effective filtering of radio frequency noise and damping the resonance between the audio component and power lines. In short... If we have less noise we can hear cleaner and more dynamic music.

## Speaker Wire - A History

### Introduction

For many years, wires that were used to connect speaker systems were often zip or line cord. The longer the run was, the heavier the wire that was used. There were no special speaker wires--just plain old copper wire - solid or stranded. The emergence of high tech speaker wire has raised some fundamental questions about the benefits of these new and sometimes extremely expensive wires.

**Resistance in the speaker circuit is the key factor that determines loudspeaker performance.** The loudspeaker circuit includes the connecting wire between the amplifier terminals and the speaker terminals, the amplifier internal impedance and the impedance of the speaker system. There's also contact resistance at the connecting terminals of the amplifier and speaker system. (See my page about connecting terminals.)

The contact resistance of clean connectors and the internal impedance of good quality amplifiers is normally small. The controlling factors that remain are the speaker system impedance and the speaker wire resistance.

The DC resistance of a typical 8-ohm speaker system is about 7 ohms. This resistance is due to the wire in the woofer voice coil. It may be a total shock to some people to know that a typical 8-ohm four layer woofer voice coil contains about 120 feet of number 28 solid copper wire. This wire is all in the circuit with the speaker system hookup wire. It's also much longer than a normal run of hookup wire from the amplifier to the speaker. Even a mid range speaker can have about 30 feet of number 33 solid copper wire and a tweeter can have 20 feet of number 35 solid copper wire.

### Wire Table

In the early speaker manuals, starting with the XR5, I included a chart for estimating the maximum wire lengths for various sizes of copper wire needed for 4 and 8 ohm loads. I have expanded it on this page to include 2 and 6 ohm loads as well. It was based on the resistance of the speaker wire not exceeding 5% of the rated impedance of the system. The wire length is for TWO-CONDUCTOR wire. This includes one wire out to the speaker and one wire back again.

### Maximum Wire Lengths For TWO CONDUCTOR Copper Wire

Wire Size	2 ohm load	4 ohm load	6 ohm load	8 ohm load
22 AWG	3 feet max	6 feet max	9 feet max	12 feet max
20 AWG	5 feet max	10 feet max	15 feet max	20 feet max
18 AWG	8 feet max	15 feet max	23 feet max	30 feet max
16 AWG	12 feet max	25 feet max	37 feet max	50 feet max
14 AWG	20 feet max	40 feet max		
12 AWG	31 feet max			
10 AWG	50 feet max			

For example: you can use #18 wire for a 25 foot run to a nominal 8 ohm speaker, but if the run is increased to 35 feet, #16 wire must be used. 50 feet is the maximum recommended length for normal line cord or Romex solid copper wire. This length is more than adequate for most installations. An explanation is further down on this page titled "What about Wires Longer Than 50 Feet?".

A wire resistance of less than 5% of the nominal speaker impedance is chosen to work well with almost all speaker systems and can be considered conservative. Even a resistance of less than 10% of the nominal value could be used with some speakers and would not be audible. A further explanation can be found in the next section.

## Cable Resistance Too High?

What happens when the resistance gets too high? First, there is power lost in the wire and the speaker will not play as loud. More important, as the resistance in series with the speaker increases, it makes the amplifier look more like a current source. This means the speaker frequency response will tend to follow the rise and fall of its impedance curve.

The impedance of most speaker systems is not constant with frequency. A speaker that is rated at 8 ohms may be exactly 8 ohms at only a few frequencies. The rest of the time it may wander above and below this value several times.

As the wire resistance increases, it becomes significant compared to the speaker impedance. It will affect the areas of lower impedance values first and eventually will be audible. Speakers with small impedance variations versus frequency, and that don't dip below the nominal impedance, will be more tolerant of higher resistance in the speaker wire. On the other hand, speakers with large variations in impedance that dip below the nominal value will be much easier to notice. If the speaker has constant impedance versus frequency, the only change will be reduced output.

## Cable Resistance Too Low?

What if you use wire heavier than the minimum size recommended in the table? **There is no audible improvement but there can be a considerable increase in cost.** On the other hand, it would be a conservative choice, particularly for in-the-wall installation where you might someday be using lower impedance speakers and would need to replace the existing wire with heavier wire. Solid copper house wiring is sometimes less expensive than multi-stranded wire. Heavier solid wire is harder to work with, though, and that may require special connectors to fit the amplifier and speaker terminals.

## What about oxygen free wire?

Oddly enough, it isn't the freedom of oxygen in copper wire that makes any difference. The process of removing oxygen also removes the impurity of iron and it's this impurity that can cause the resistance to be slightly higher. The difference in resistance between copper wire and oxygen free copper wire is too small to be significant for speaker wiring. It can be considered to be ordinary copper wire as far as the recommended lengths of copper wire in the table. Oxygen free copper wire can be more expensive than ordinary copper wire.

## What about silver wire?

Silver wire has lower resistance compared to the same gauge of copper wire. Smaller silver wire can be used for the same resistance. It may cost more, though.

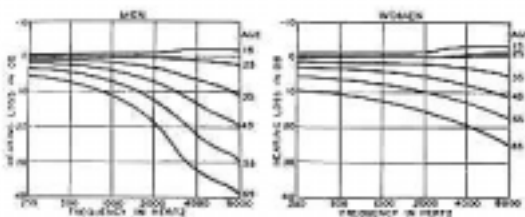

## What About Wires Longer Than 50 Feet?

Besides losses due to cable resistance, longer cables begin to exhibit a significant reactive component of capacitance and inductance. Measurements show that response in the 10 kHz to 20 kHz region is affected by a small amount. Then why are differences in wires at these frequencies not heard? There are at least two reasons. Both are related to our hearing ability.

An article was published in Audio, July 1994 titled "Speaker cables: Measurements Vs Psycho-acoustic data" by Edgar Villchur. The psycho-acoustic data shows that for pure tones at 16kHz the smallest average detectable difference in level is 3.05 dB. He also indicates: "It can be predicted that at a given level the just noticeable difference will be increased by a significantly greater amount by the masking effect of musical sound below 10 kHz." (See note 1). The findings were based on individuals 20 to 24 years old that had normal hearing to 20 kHz (See note 2). This is what might be called the best of conditions for hearing differences.

However, as we age, our sensitivity to high frequencies decreases dramatically. The chart is from Modern Sound Reproduction by Harry F. Olson. It shows the average hearing loss Vs age for men and women at frequencies from 250 Hz to 8000 Hz. This means that for a man at age 35, sensitivity is down about 11 dB at 8000 Hz. For a woman at that age, sensitivity is down only about 5 dB. We can infer that sensitivity is down a whole lot more at 20kHz.

So for these two reasons this measurable high frequency wire loss in the 10 to 20kHz region is not audible for a moderately long wires like 50 feet. Longer runs may still not be audible for some people, provided the wire resistance is kept low enough.

(Note 1) An article was published in the Journal of the Audio Engineering Society by Lipshitz and Vanderkooy titled "The Great Debate: Subjective Evaluation" Volume 29, No. 7/8 July/August. They estimated that when level differences occurred over a wide band, they were detectable down to 0.2 dB. However, in a phone conversation with Villchur, Lipshitz agreed this figure is not applicable to speaker cables where the level differences are all in the highest audio octave.

(Note 2) Villchur gives a reference of Florentine, Buns and Mason "Level Discrimination As a Function of Level for Tones from 0.25 to 16kHz" Journal of the Acoustical Society of America, Vol. 81, No. 5 (May 1987)

### Gordon Gow's Speaker Wire Listening Test

I have read several magazine articles and papers expressing the findings and opinions about the various kinds of speaker wire. Some engineers have applied their expertise to make measurements to prove conclusively that there ARE differences between wires. A few authors have devoted their entire paper to the measurements and never mention whether they have actually made any listening tests or if they could hear any difference. Despite all the measurements and opinions, the final test is whether you can hear any difference or not. Obviously this must be done under controlled conditions where you don't know which wire is connected and there is no delay in switching.



In the early 1980's, special speaker wires were beginning to appear on the market. Some of the claims were totally unbelievable and had prices to match. Realizing that wire resistance was the critical factor in speaker wire, Gordon Gow, President of McIntosh Laboratory, used a speaker cable demonstration to show there was no listening difference between these wires and plain line cord. He delivered his presentation about the truth in speaker wire using a reel of Monster cable to stand on. Fifty-foot lengths of wire were used in the comparison. The setup consisted of a master control relay box and two slave relay boxes. A three-position switch was used to select one of three different speaker wires of equal length. One was line cord. The other two wires were from popular manufacturers. 8-ohm speakers were selected to be used in the test.

The two other brand name wires were heavier than the line cord.



A slave box was positioned at each speaker. Power to drive the relays in each slave box was provided with separate cables. The speaker wires were switched at both the power amplifier and the speaker so that only one kind of wire was connected at a time. Short pieces of heavy wire were run from the speakers and amplifier to the relay boxes. No other devices were used in the speaker line. The relay contact resistance was measured to be less than 0.1 ohms.

The test proved his point. When I took the test, I was unable to hear any differences using several different 8-ohm speaker systems. BUT, when I deliberately played one particular 4-ohm speaker and I switched to the line cord position, I could hear differences. I knew this system dipped down to 2.6 ohms in one frequency range, and 3 ohms in another. It verified that differences could be heard if the wire was too light for a lower impedance system. A system this low in impedance required heavier wire. After replacing the line cord with a heavier line cord of equal length, differences could no longer be heard.

Normally, a system can run as low as 20% below rated impedance. Although many speaker systems stay within this limit, or higher, a few systems can have impedance values much lower, depending on the manufacturer. If you have doubts, it's best to ask the manufacturer about the lowest impedance of the system that you plan to use and select a connecting wire based on the lowest impedance value.

The lowest impedance limit for McIntosh speaker designs was 6.4 ohms, for a nominal 8-ohm system. The wire selection table was calculated with this in mind. Another reason was that the 8-ohm tap on McIntosh amplifiers could safely drive impedance as low as 6.4 ohms without requiring connection to the 4-ohm tap. Direct-coupled amplifiers, of course, did not have this restriction.

## **THE KIND OF WIRE MADE NO DIFFERENCE**

**It can be solid, stranded, copper, oxygen free copper, silver, etc.--or even "magic" wire--as long as the resistance is kept to be less than 5% of the speaker impedance. There is no listening difference as long as the wire is of adequate size.**

Of course, we are not personally able to establish the truth of everything for ourselves and it's not easy to set up a similar wire listening test. Very few people are able to make speaker impedance measurements or wire resistance measurements down to 0.1 ohms. Like many other things in life, we rely on indirect sources of information, such as sales literature, reviews and opinions. This is called Authority Belief, which is part of our belief system. An interesting article about the belief system is described in ETC: A Review Of General Semantics Sept. 1964 titled Images Of the Consumer's Mind by Milton Rokeach.

Gordon Gow's cable demonstration provided a personal experience for customers that could replace the Authority Beliefs they had relied on earlier. The demonstration was controlled. It was an instant comparison and the listeners did not know the wire identification. Gordon held many such demonstrations in dealer showrooms and at shows.

## **The Truth About Speaker Wire**

Despite the effectiveness of Gordon's cable demonstration and the truth about speaker wire, people visiting the McIntosh room at the shows, who had not experienced the cable demonstration, were disturbed that we were using ordinary heavy zip cord instead of one of the popular brands of speaker wire. Instead of listening to the McIntosh speakers and electronics, they recalled "bad" things they had been told about "common" speaker wire and this promoted questions about the "inferior" wire being used. When we changed the wire to a popular brand of wire, customers were happy with the setup, and directed their attention to the McIntosh equipment.

The demand for high quality speaker wire was increasing and appeared to be a new marketing area for several companies. McIntosh did not make or sell speaker wire. The solution seemed very obvious--rather than spend time and effort to create negative sales for McIntosh dealers who were beginning to sell speaker wire, it seemed best to encourage the speaker owner/customer to consult with the dealer about what speaker wire to use. Consequently, I no longer recommended the kind of wire or wire sizes in the speaker manuals.

By 1988, McIntosh no longer supplied audio interconnects with the electronics. Again, many kinds of special audio cables were available to the customer/owner. The dealer could also be consulted about what cables to use.

I credit the success of the speaker wire industry to their expert sales and marketing ability. However, it is my experience that ordinary copper wire, as long as it's heavy enough, is just as good as name brands.

## **Stereo Review Dares to Tell the Truth (1983)**

A 6-page article by Laurence Greenhill titled "Speaker Cables: Can You Hear the Difference?" was published in Stereo Review magazine on August 1983. It compared Monster cable, 16-gauge wire and 24-gauge wire. The price at that time for a pair of 30-foot lengths of monster cables was \$55.00. The cost for 16 gauge heavy lamp cord was \$.30/foot or \$18.00 and the 24 gauge "speaker wire" was \$.03/foot or \$1.80

"...So what do our fifty hours of testing, scoring and listening to speaker cables amount to? Only that 16-gauge lamp cord and Monster cable are indistinguishable from each other with music and seem to be superior to the 24 gauge wire commonly sold or given away as 'speaker cable.' Remember, however, that it was a measurable characteristic--higher resistance per foot--that made 24 gauge sound different from the other cables. If the cable runs were only 6 instead of 30 feet, the overall cable resistances would have been lower and our tests would probably have found no audible differences between the three cables. This project was unable to validate the sonic benefits claimed for exotic speaker cables over common 16-gauge zip cord. We can only conclude, therefore, that there is little advantage besides pride of ownership in using these thick, expensive wires"

Needless to say there was a strong letter to the editor in the October Stereo Review from Noel Lee, President of Monster Cable. "...was not the conclusion of nearly three thousand Monster Cable purchasers who participated in a warranty/response card survey in 1981-1982. Among those responding, 56 per cent indicated 'an overall significant improvement, '42 per cent attested to a 'noticeable improvement,' and only 2 per cent wrote back that they heard no difference in system performance."...

Yes, some of this claim is believable but for the wrong reasons. If the wire used previously had resistance that was too high, there would be an audible difference. If the wire connections at the amplifier or speaker were loose or corroded, installing the new cable tightly would make an audible difference.

Then we get into the more subjective evaluation. Suppose you're already using adequate size wire and have good connections at the speaker and amplifier. If you're then told the new wire will make an improvement, you will be looking for it and truly believe that you hear an improvement. Some people might go as far as saying "If I spent all that money for these cables, you can be sure I'm going to hear a difference." (rather than admit I wasted my money or have bad hearing).

There are other factors as well. If you listen to the system with the old wires and then replace them with the new ones, it could take 5 or 10 minutes to do this. By then you will have forgotten what the old sound was like. How many of the customers made an instant and more reliable comparison like what was done in Gordon Gow's demonstration or in the Stereo Review test? I wonder how these customers would fare in a test where they didn't know which wire was being used.

### **Stereo Review Gets More Conservative (1990)**

A 5 page article by Rich Warren titled "Getting Wired" was published in Stereo Review in June 1990. It devotes 4 and a half pages to the creative claims and descriptions by the various wire manufacturers. Near the end of the article reference is made to an Audio Engineering Society paper by R. A. Greiner published in the JAES in May 1980 and titled "Amplifier-Loudspeaker Interfacing." **The conclusion is that speaker cables do not behave as transmission lines despite the theory subscribed to by many, if not most, esoteric cable designers.**

This time the conclusion in Stereo Review was extremely conservative. Perhaps this was due to the influence of speaker wire advertisers who pay for their magazine ads. As in Gordon Gow's wire demonstration, wire sales, advertising and dealer profits were hurt by the truth about speaker wire.

„Are there real sonic differences between audio cables? We leave that up to each individual to decide. What we can say is that there are some valid reasons, described in the box on the facing page (cable pictures and manufacturer descriptions), to use good cables in your hi-fi system. Which theory you choose to subscribe to and how high a price you're willing to pay for cable comfort is up to you."

## An Honest Answer from Sound & Vision (2001)

Here's an answer by Ian Masters in the May 2001 issue of Sound & Vision, page 36 Q&A.

Note: I saw no speaker wire advertisements in this issue!

"Cheap Wire"

Q. Would it be okay for me to use single conductor wire as speaker cables running through the attic or under the house? Does stranded wire provide some sonic benefit? It would be far cheaper and easier for me to run 12-gauge wire to a plate with banana receptacles and then use specialty cable at each end to patch to the amplifier and speakers. Jon Schwendig, Santa Clara, CA

A. **There are a lot of myths about speaker wires, but in the end it's thickness that counts**, and 12 gauge should be heavy enough for any reasonable domestic application. I've taken several comparative listening sessions over the years, and the sort of wire you want to use involves no sonic degradation that I (or anybody else in the tests) could hear. You could even wire the whole distance from amp to speakers using 12-gauge, but it would probably be more convenient to use something more flexible for the actual connection to components. Specialty audiophile cables would serve that purpose nicely, although more modest cables would work just as well."

### All Low Cost Wires Are Not the Same



Here's some typical low cost wire that's available today. The wire at the left with the heavy insulation is 12-gauge low voltage cable that's used for garden lighting accessories. It's 1/2" wide and cost 28 cents/foot. The white lamp or extension cord is 16-gauge and is about 1/4" wide. It cost 25 cents/foot. The black wire at the right is 24-gauge "speaker wire" that came

with a receiver. It's only 1/8" wide. Although the 24-gauge wire is very small, it is only 8 feet long. That works out to just 5% of the impedance for an 8-ohm speaker or 0.4 ohms.

All of this wire is stranded and is easy to work with. All the wires are coded so that you can maintain proper phasing of the speakers. The smaller wire has a white stripe on the insulation of one of the conductors. The other two have ridges molded in the insulation covering one of the conductors.

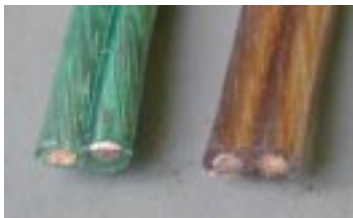

All inexpensive wires are not the same, However. This wire at the right is sold as speaker wire by such places as Home Depot and Lowes. It sells for 33 cents/foot. It has transparent insulation and is 12-gauge. It is much less expensive than the brand names. It does not have any coding to identify one of the wires for proper phasing. I had some of this wire for about 6 months and noticed it was turning color. Now it has turned a very pronounced green on the surface of the copper wire indicating a chemical interaction with the

insulation and the copper. A new piece of wire is at the right for comparison. Although the wire may not corrode further, it doesn't inspire confidence, particularly if the insulation comes close to the connecting terminals.

Perhaps the transparent insulation is an attempt to mimic the more expensive speaker wires. Without researching the chemical properties of the insulation or the need to code one of the wires, it is not well thought out for use as speaker wire. I have heard complaints by others about the same problems. The normal lighting wires and wire supplied with the receiver shown above do not have these problems.



# Analysis Plus

## White Paper on Cables (Report 981)

### **A Measurably Better Audio Cable**

Analysis Plus Inc., provides leading-edge research and technology in the field of electronic systems and components. Many of our customers are major names in high-end audio and home theater equipment. These manufacturers rely on us for our skills, reputation, and expertise during all phases of product development.

Our recent innovations in audio cable design were prompted by the realization that we could substantially improve the state-of-the art in cable design and performance. Along with our background in electrical engineering, we are also audiophiles and wanted to create the best cables available anywhere--period!

### **What Makes a Good Audio Cable?**

While testing audio cables for several well-known manufacturers, we learned that their criteria for what supposedly made one cable perform better or worse than another was remarkably inconsistent. One manufacturer's claims countered and negated the claims made by a different manufacturer. Yet each one purported to be the best! As we studied the available literature, we quickly realized that the source of the problem was a lack of hard evidence supporting all the hype. None of the manufacturers offered documented, measurable evidence that it was producing a superior cable. Instead, we found claims of allegedly superior components or materials used in cable construction.

For example, a few leading manufacturers claimed that the most important factor for a cable was low capacitance, using the justification that cable capacitance shunts upper frequencies to ground. In order to lower the capacitance, these companies increased conductor spacing to simultaneously achieve a goal of increased inductance. This approach had drastic side effects, however. Merely decreasing capacitance without taking other realities of signal transmission into consideration increased the noise pickup and introduced a blocking filter. Both of these effects would obviously degrade sonic performance rather than improving it.

Another cable manufacturer advertised that its cable "employs two polymer shafts to dampen conductor resistance", but offered no evidence to prove it. Still another audiophile company claimed that because its cable was flat, "with no twist, it has no inductance". In general, inductance can indeed be reduced by making conductors larger or bringing them closer together. However, physics shows that, in reality, no cable can be built without some level of inductance, so this claim is without scientific merit.

To convey musical information effectively, a cable must provide a structured, low impedance path for the desired signal. This became our goal at Analysis Plus, Inc. We began by applying our expertise in electromagnetic computer simulation and design to rigorously test and study a broad range of audiophile cables currently on the market. Based on what we learned, we then set about designing our own approach to audiophile cables, relying on solid, measurable data rather than subjective claims.

### **Cylindrical Cable Conductors and Skin Effect**

Most of the popular loudspeaker and musical instrument cables on the market employ cylindrical (a.k.a. round-diameter) cables as conductors. Unfortunately, cylindrical cable designs have a number of serious drawbacks, including current bunching, skin effect phenomenon, and frequency effects that lower the performance of the cable.

It's a common misconception to think about electrical transmission in cables in terms of direct current (DC) alone. Even experienced electrical engineers frequently ignore the ramifications of frequency on cable performance. In the case of DC, current is indeed uniformly distributed across the entire cross-section of the wire conductor, and the resistance is a simple function of the cross-sectional area (see figure 1a). Adding the frequency of an electrical signal to the equation complicates the situation, however. As frequency increases, the resistance of a conductor also increases due to skin effect.

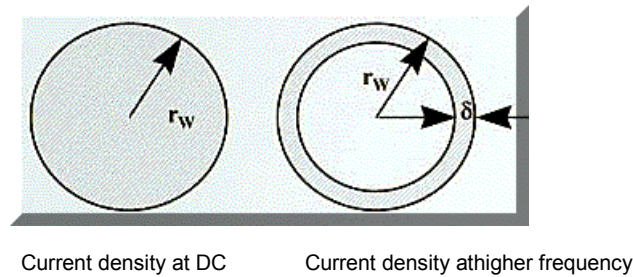

Figure 1a (left) and 1b (right) is of a round cable showing the effect of skin depth where  $R_w$  is the radius of the wire and  $\sigma$  is the skin depth. The shaded region represents the current density.

Skin effect describes a condition in which, due to the magnetic fields produced by current following through a conductor, the current tends to concentrate near the conductor surface (see figure 1b). As the frequency increases, more of the current is concentrated closer to the surface. This effectively decreases the cross-section through which the current flows, and therefore increases the effective resistance.

The current can be assumed to concentrate in an annulus at the wire surface at a thickness equal to the skin depth. For copper wire the skin depth vs. frequency is as follows:

60 Hz:  $\sigma = 8.5$  mm, 1kHz:  $\sigma = 2.09$  mm, 10 kHz:  $\sigma = 0.66$  mm, 100 kHz:  $\sigma = 0.21$  mm.

Note that the skin depth becomes very small as the frequency increases. Consequently, the center area of the wire is to a large extent bypassed by the signal as the frequency increases (see Figure 2b). In other words, most of the conductor material effectively goes to waste since little of it is used to transmit the signal. The result is a loss of cable performance that can be measured as well as heard.

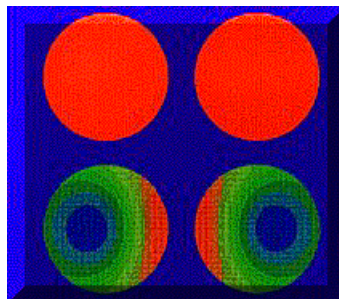

Figure 2a (top) shows uniform current distribution at DC.

Figure 2b (bottom) shows the effect of current bunching and skin effects at 20kHz.

### Current Bunching

Current bunching (also called proximity effect) occurs in the majority of cables on the market that follow the conventional cylindrical two-conductor design (i.e., two cylindrical conductors placed side-by-side and separated by a dielectric).

When a pair of these cylindrical conductors supplies current to a load, the return current (flowing away from the load) tends to flow as closely as possible to the supply current (flowing toward the load). As the frequency increases, the return current decreases its distance from the supply current in an attempt to minimize the loop area. Current flow will therefore not be uniform at high frequencies, but will tend to bunch-in. This can be seen in Figure 2b, which illustrates typical current density distribution in a cross-section view of a pair of cylindrical 12-gauge wires at 20 kHz. The density shadings are shown in color, with red being the highest current density and purple the lowest current density.

The current bunching phenomenon causes the resistance of the wires to increase as frequency increases, since less and less of the wire is being used to transmit current. The resistance of the wire is related to its cross-sectional area, and as the frequency increases, the effective cross-sectional area of the wires decreases. In order to convey the widest frequency audio signal to a loudspeaker, you want to use as much of the conductor cross-section as possible, so excessive current bunching is extremely inefficient.

### Disadvantages of Rectangular Conductors

As a means of bypassing the skin effect and current bunching problems associated with cylindrical conductor designs, some cable manufacturers have developed rectangular conductors as an alternative. These designs typically use a one-piece, solid core conductor.

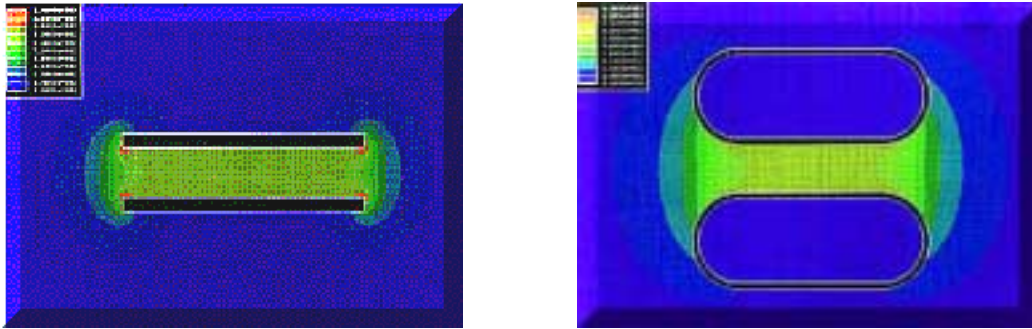

Figure b (left)

Computer simulation showing the magnitude (volts/meter) of the electric field between two solid rectangular conductors. The conductors have a cross section area equivalent to a 10 gauge conductor. The spacing between the two conductors is 2mm with a voltage of +1 volt applied to the top conductor and -1 volt applied to the bottom conductor.

Figure c (right)

Computer simulation showing the magnitude (volts/meter) of the electric field between two hollow oval conductors. The conductors have a cross section area equivalent to a 10 gauge conductor. The spacing between the two conductors is 2mm with a voltage of +1 volt applied to the top conductor and -1 volt applied to the bottom conductor.

A solid rectangular conductor of this type is undesirable because the sharp corners produce high electric field values that over time can break down the dielectric, causing a failure of the cable (see Figure b). In general, cables with solid conductors are prone to shape distortions and kinking due to their poor flexibility. This becomes an especially important issue with rectangular cable designs. The sharp corners from rectangular conductors tend to chafe the cable dielectric if the cable is repeatedly flexed or put under stress, and this chafing can lead to a short that could conceivably damage your loudspeakers.

### The Hollow Oval Cable Solution

After many computer simulations and other exhaustive tests, the engineers at Analysis Plus, Inc., reached an innovative solution that flew in the face of conventional wisdom on audio cable geometry. Our engineers determined that a hollow oval cable constituted the best possible conductor design. Here's why.

The primary advantage of an oval conductor design rather than cylindrical conductor geometry is that the oval shape allows more of the return current to be closer to the outgoing current, thus reducing the negative effects associated with excessive current bunching.

Figure 1 illustrates that at DC the current is uniformly distributed across the cross-section of the wire, but as the frequency gets higher, the current is distributed near the surface. Since the center part of the conductor is not used at high frequencies, we can simply eliminate it. By using a hollow conductor, we help minimize the change in resistance with frequency and the cable becomes more efficient.

### Advantages of a Braided Conductor

Along with the innovative hollow oval conductor design in our Oval cable product line, we also determined that a braided conductor was superior to solid core conductors for two significant reasons.

The most obvious advantage of a braided conductor is that it yields a more mechanically reliable cable than solid conductor designs. A woven or braided cable is more flexible and resistant to stress fractures resulting from continual flexing than a solid cable. A solid cable is also more susceptible to kinks and other deformations when handled. Our cable can be handled easily, and it returns to its original shape when flexed. The flexibility of our cable also prevents the geometry of the conductors from changing with use. If the geometry changes, the cable characteristics will change, and kinks will add impedance mismatches--inducing distortion in the signal.

Braided cable has yet another advantage over solid core conductors. Analysis Plus, Inc., uses a woven pattern in its Oval cables where every wire is statistically as close to the return current as every other wire. The current density is now more evenly distributed between the strands. As a result, the resistance of our Oval cables is extremely constant over a variety of frequencies--much more so than solid-core cylindrical cables, as can be seen in Figure 3.

### Characteristic Impedance Complexity

Another parameter that is critical in cable design is characteristic impedance. But because of its complexity, this important factor is often misunderstood.

The characteristic impedance of a cable is given by  $Z = [(R + j\omega L)/(G + j\omega C)]^{1/2}$  where R is the series resistance, L is the series inductance, G is the shunt conductance, C is the shunt capacitance, and  $\omega$  is the angular frequency ( $\omega = 2\pi \cdot f$ ).

Note that this is not a simple number for a cable, but one which changes with frequency. It is also important to note that R, L, G, and C also change with frequency, making the impedance of a cable even more frequency dependent.

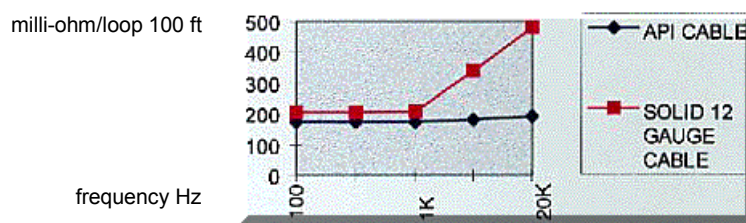

R vs.f Measured with HP 4263A LCR meter

Figure 3

Z is a complex number, and it is common practice in the cable industry to simplify the situation by assuming a loss less transmission line and, in turn, assuming that R and G are zero. While this may be a valid approximation at high frequencies, it is not valid at low audio frequencies if you plan to construct an accurate model of a cable.

For example, stating that a speaker cable has a constant, characteristic impedance of 10 ohms across the entire frequency range of 20 to 20,000 Hz is a drastic oversimplification that, in the end, is simply untrue. The same type of statement is also inaccurate when applied to loudspeakers, as the table below shows. A speaker only has a constant impedance of 8 ohms at a single fixed frequency. To state otherwise is to ignore the complexity of impedance changes as signal frequency changes.

	100 Hz	120 Hz	1 kHz	10 kHz	20 kHz
EPI 100 (W)	4.54 < -13.8°	4.43 < -3.84°	12.84 < +9.81°	6.26 < +13.85°	8.01 < +29.21°
BOSE 901 (W)	16.5 < +49.1°	26.3 < +43.4°	8.72 < +15.9°	26.4 < +47.5°	38.3 < +47.2°
JBL TI 250 (W)	6.17 < -14.4°	6.42 < -2.15°	10.38 < -2.1°	5.22 < -13.4°	6.10 < +6.41°

Table 3b (Measured speaker impedance with a 4632A LCR meter)

### Minimizing Impedance Mismatch

Our Oval cables minimize frequency changes and boast a low impedance to reduce reflections at the high end of the audio frequency range.

Conventional cylindrical cable, due to its geometric limitations, typically has an impedance of about 100 ohms at the high end of the audio frequency band, thereby causing an impedance mismatch at high frequencies. In an attempt to eliminate impedance mismatch, some audiophile cable companies introduce passive components into their cables. However, these components can do more harm than good by introducing another possible source of pollution (or distortion) to the signal.

As shown in Figure 3, Analysis Plus, Inc., Oval cables minimize the change in resistance with frequency. Our exclusive braided conductor, hollow oval design also minimizes the frequency dependence of the inductance L as shown in Figure 4. By minimizing current bunching and skin depth problems, we minimize unwanted distortion, maximizing transparency and realism.

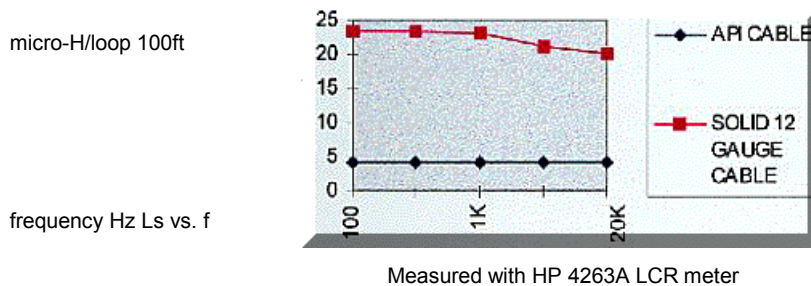

Figure 4

### Frequency Blurring

To minimize frequency blurring, it is important that the speaker cable parameters do not change with frequency. Ideally, the resistance and inductance would remain constant as the frequency of the signal changes. Figure 3 and 4 show that Analysis Plus, Inc., Oval cable minimizes the change of R and L with shifts in frequency, thus minimizing frequency blurring.

### Wave Good bye to EMI

Electromagnetic Interference (EMI) is commonly encountered when multiple electronic devices are operated in close proximity to one another. Almost everyone has heard or seen the interfering effect of a vacuum cleaner, lawnmower engine, hair dryer, or blender on a radio or television. These are examples of EMI, which can also significantly degrade the performance of a hi-fi system. How does EMI get into your system? AC wiring is one route. But even when this entry point is eliminated by using power conditioning components, EMI still gets into the signal path. Speaker cables are frequently the culprit.

As discussed on page 29 of Henry W. Ott's Noise Reduction Techniques in Electronic Systems, loudspeaker cables generally comprise the longest parts of a system and therefore act as antennae that pick up and/or radiate noise.

While all real-world cables fall short of ideal behavior in eliminating the problems of EMI, our Oval cables perform closer to the ideal than any other cable currently on the market. To reduce EMI, it is important to have a low inductance. Our Oval cables exhibit low inductance which helps reduce noise and therefore improves the final sound.

Figures 5 and 6 show the superiority of Analysis Plus cable to other cable designs. The two plots in the graph represent measured data taken using a digital oscilloscope and a signal generator to produce a test signal. The purple waveform shows the source signal at the amplifier. The green waveform shows the signal after transmission to the speaker through a cable. For best performance, a cable should not distort the signal--the source signal and the signal at the speaker should show similar if not nearly identical waveforms.

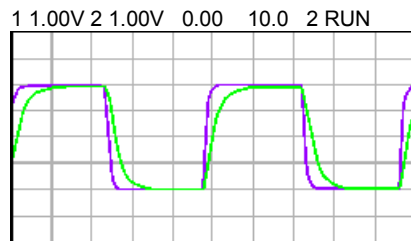

Figure 5: Purple showing signal at amplifier  
Green showing signal at speaker using OMC cable.

Figure 5 shows that the leading large-diameter audiophile cable greatly distorted the signal that the speaker receives. (Note the difference between the purple and green waveforms). Figure 6, in marked contrast, shows that a signal passed through the Analysis Plus, Inc., Oval cable to the speaker is essentially identical to the signal at the amplifier.

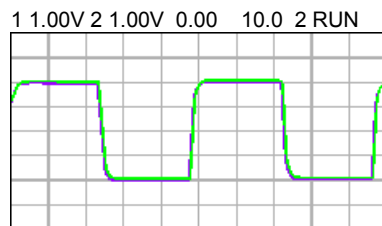

Figure 6 Purple showing signal at amplifier.  
Green showing signal at speaker using API speaker cable.  
Imagine how much music you have been missing simply due to inferior cable!

### The Best Test Instrument--Your Ears

Finally, we turn our attention to human hearing. After all, our end goal at Analysis Plus, Inc., is to bring our customers the best sound possible, and your ears are the ultimate judges of our success.

The faintest sound wave a normal human ear can hear is  $10^{-12}$  Wm<sup>-2</sup>. At the other extreme of the spectrum, the threshold of pain is 1 Wm<sup>-2</sup>. This is a very impressive auditory range. The ear, together with the brain, constantly performs amazing feats of sound processing that our fastest and most powerful computers cannot even approach.

As long ago as 1935 Wilska<sup>2</sup> succeeded in measuring the magnitude of movement of the eardrum at the threshold of audio sensitivity across various frequencies. At 3,000 Hz, it takes a minimal amount of eardrum displacement (somewhat less than  $10^{-9}$  cm or about 0.01 times the diameter of an atom of hydrogen) to produce a minimal perceptible sound. This is an amazingly small number! The extremely small amount of acoustic pressure necessary to produce the threshold sensation of sound brings up an interesting question. Does the limiting factor in hearing minimal level sounds lie in the anatomy and physiology of hearing or in the physical properties of air as a transmitting medium?

We know that air molecules are in constant random motion, a motion related to temperature. This phenomenon is known as Brownian movement and produces a spectrum of thermal-acoustic noise.

In 1933, Sivian and White<sup>3</sup> experimentally evaluated the pressure magnitudes of these thermal sounds between 1kHz and 6 kHz. They observed that throughout the measured spectrum the root-mean-square thermal noise pressure was about 86 decibels below one dyne per square centimeter.

The minimum root-mean-square pressure that can produce audible sensation between 1 kHz and 6 kHz in a human being with average hearing is about 76 decibels below one dyne per square centimeter, but in some people with exceptionally acute hearing may approach 85 decibels.

These figures indicate that the acuity of persons possessing a high sensitivity of hearing closely approaches the thermal noise level, and a particularly good auditory system actually does approach this level. Furthermore, it is not likely that animals possess greater acuity of hearing in this spectrum, as their hearing would also be limited by thermal noise.

What this means is that the human audio system is extremely sensitive, and that small things like cable design are important to maximize the listening pleasure. At Analysis Plus, Inc., we're committed to doing our part by bringing you the best-sounding audiophile cables on the market.

#### References

1 Henry W. Ott, Noise Reduction Techniques in Electronics System (New York, NY John Wiley and Sons, 1988, p. 150)

2 Wilska, A.: Eine methode zur Bestimmung der Horschwellenamplituden des Trommelfells bei verschiedenen Frequenzen, Skandinav. Arch. Physiol., 72:161, 1935.

3 Sivian, L.J., and White, S.D.: On minimum audible sound fields, J. Acous. Soc. Am., 4:288, 1933

#### Why do hollow oval cables sound better?

The following plots are from a computer simulation of three balanced audio interconnect cables. The graphics display the current distribution in a cross section of each cable.

Note: The cross-sectional area of all three cables is identical.

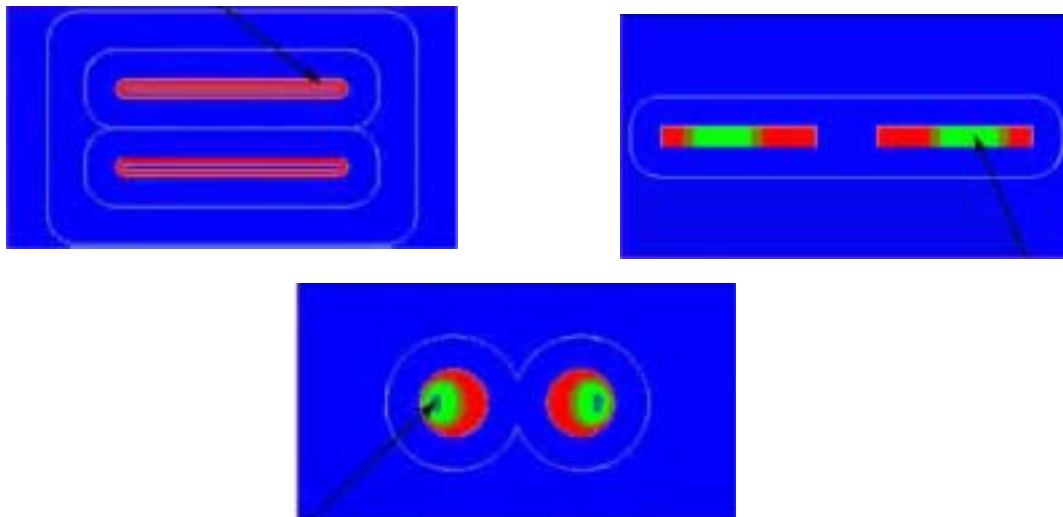

With the Analysis Plus hollow oval design, note the uniformity of the current distribution, even at 20 kHz. This is why the electrical properties of our cables don't change, and why more of the music is delivered to your speakers and your ears.

# Argento

The driving force behind the Danish company Argento was the ambition to create nothing less than the ultimate audio cables. The name Argento is derived from the Latin for silver; "Argentum". Argento's mission is to develop a range of cables that delivers all information from the recorded source to the listener without loss or coloration.

All Argento cables are extremely coherent and open across the audible frequency range. An important part of the development process is the use of intensive listening tests, all conducted as double blind sessions with both experienced and inexperienced listeners. This is a long and complicated process, but a necessary one when the goal is to develop the ideal audio cable.

Argento cables employ metals of highest possible purity in heavy gauge configurations. When it comes to reproducing music, there is no substitute for pure metal. In addition to using the best possible materials, Argento has dealt effectively with the skin effect problem. The problem occurs when the electric signal passes through the wire. High frequencies tend to move faster than low frequencies and this causes undesirable phase problems. Skin effect is either eliminated or minimized in all Argento cables.

**Argento only designs unshielded cables, as they deliver the most natural sound quality.**

The plugs RCA, XLR, BNC and spades have all been chosen for their sonic qualities. All soldering connections employ silver tin which is shielded against corrosion.

## **Copper:**

The original Argento construction techniques are used in this series, i.e. the cable is made of fine coiled cores exclusively with pure copper conductors and Teflon insulation. This construction minimizes skin effect problems and ensures coherent reproduction across the audible spectrum. We do not use silver-coated copper as this results in uneven electron speed in the cable. All cables use identical cores for the outgoing current as well as the return signal. This ensures linear flow throughout the cable.

## **Silver:**

The classic Argento cable is made of pure silver, as this is the best conductor and at the same time the best sounding material for music reproduction.

The general assumption that silver in the signal path results in cold treble and insufficient bass response must be based on experience with silver cables with a poor silver quality, such as silver plated-copper or a silver alloy such as Sterling silver.

## **VDM:**

Argento has developed an exceptional cable, which is the result of many years of listening and scientific tests. The VDM cable is specially designed to eliminate skin effect, vibration and static electricity in the cable. This technique pushes back the boundaries for what has previously been obtainable in cable fidelity.

## **Manufacturing methods:**

Argento cables are wound carefully and loosely. Care is taken to preserve the delicate crystalline structure of the conductor and we wind the strands loosely to reduce contact between individual strands. Our winding technique also protects against bending and breaking, which would deform the long-crystal structure, reduce the crystals and increase the distance between them.

Argento employs only the finest long-crystal metal quality (either silver or copper).

Argento does not employ metal alloys, because of their smaller crystals. In pure metals, there are fewer contact points between conductive crystals than in alloys. The conductors are mechanically damped to reduce microphonics. Because insulation is required to prevent corrosion and short circuiting, Argento employs Teflon for its dielectric properties and outstanding mechanical stability.



Most interconnects are constructed with an outer shield used either as an actual signal carrier or for shielding. But in fact, unshielded cables (even when carrying the sensitive, low-level signal from an MC cartridge to a phono stage) rarely pick up audible interference. However, it is always advisable to keep interconnects and speaker cables well away from power cables in order to avoid interference.

Argento's research has demonstrated that unshielded cables offer the most natural sound reproduction. This is due to the fact that a wrap-around shield creates a permanent magnetic field around the conductor, inhibiting its ability to generate its own "free" magnetic field and resulting in veiled sound. Parallel conductors, on the other hand, virtually eliminate magnetic influence between the conductors. For these reasons, Argento cables do not employ shielding or coaxial construction.

### **Hearing is believing:**

Much of the information provided here remains controversial in some circles, despite empirical research carried out by Argento and others. Skin effect, cable directionality (the fact that cables sound different depending on which way round you connect them), cable break-in (the fact that the sound of a good cable continues to improve during an extended period of initial use) and even the basic notion that cables can sound different at all are contested by a vocal minority whose argument essentially boils down to: "We have found no objective means of measuring these effects, therefore they do not exist."

As we see it, scientific method begins with experience and observation of a phenomenon, followed by curiosity and the formulation of an hypothesis about its cause. If we find no acceptable explanation, we do not deny the existence of the phenomenon, we simply acknowledge that we are not (yet) looking in the right place for answers.

While we wait for the current state of our scientific knowledge to evolve to the point where it can adequately explain these phenomena, serious listeners and casual music lovers the world over are experiencing the difference Argento makes in their audio systems.

### **Skin effect:**

There are (at least) four distinct varieties of skin effect.

1. Electrons can migrate from the center of the conductor to its surface, instead of following a direct path along the conductor. This causes phase shift, audible as a veiling or blurring of the sound. The smaller the diameter, the smaller the effect.
2. Exchange of electrons between strands can occur along the areas where strands make contact. This occurs only in multi-strand cables and is audible as harshness in the upper frequency range. Fewer strands means less electron exchange.
3. Electrons can be captured in the insulation (a kind of capacitor effect, where part of the signal is "stored" in the insulation, then released later, introducing distortion.) This phenomenon is audible as a dulling of transients, a temporal smearing which robs sound of immediacy and spatial detail. The more electrically stable the insulation, the smaller the effect.
4. Conductor resistance can vary. This occurs when different conductive metals are used in parallel or when one metal is plated with another (silver-plated copper, etc.). The result is a loss of tonal integrity, undue emphasis on some bands of the frequency range, aggressiveness and loose or reduced bass reproduction. The more uniform the conductor material, the smaller the effect.

In Argento cables, all of these problems are reduced to an absolute minimum or eliminated entirely.

ARGENTO AUDIO wishes You many happy listenings.

## **Frequently Asked Questions:**

### **What is VDM?**

The phrase VDM in an Argento model designation indicates that the conductors in the cable are encased in an exclusive Vibration Damping Material (VDM). VDM is specially created to absorb vibration and to prevent static build-up.

Argento VDM offers clearly audible refinements in intertransient silence, dynamics and spaciousness.

### **In what way does silver sound different than copper?**

Because of our extensive experience designing cables of identical construction apart from the difference in conductive material, we have had ample opportunity to make direct comparisons between silver and copper cables. Silver is a more conductive material than copper. Sonically, this results in greater openness and transparency, extended response both at the upper and lower end of the frequency range, enhanced perception of depth, height and width in the soundstage and expanded dynamic range.

### **What is skin effect?**

Skin effect is the tendency of electrons to wander, instead of moving evenly down the conductor's cross section. Skin effect causes masking of fine detail, a closed-in top end and foreshortened soundstage depth.

Argento cables deal effectively with skin effect. For more information, You can see the more detailed section on skin effect.

# Silver Audio

The mere use of superior materials as a substitute for a problem solving design is no longer acceptable to today's high-end audio consumer. Any audio cable is a reactive, energy storing device with independent voltage and current components that affect subtle aspects of playback in a manner that depends on conductor size, material, proximity, geometry, dielectric characteristics, and termination quality, to name a few. Not content to simply "pack wire into a tube" or disguise standard commercial wire, we recognized the need for a minimalist design theme to exploit silver's propensity for greater focus while negating its potential for phase shift due to its steeper gradient of AC resistivity. To approach full transparency, Silver Audio's entire product line was built on the irrefutable logic of using more than one individually insulated, unusually thin silver conductor per polarity (the Litz concept) rather than a single large round conductor. Our thin conductor method reduces both self-inductance, the origin of the much misunderstood "skin effect" (a phase shift phenomenon) and capacitive surface area without drawbacks ONLY when sufficiently low series resistance is achieved in a precise, double-balanced configuration. When a signal lead is split into two or more runs, an extremely precise geometry is required to ensure each run experiences identical reactive effects throughout the entire length of the cable. Moving up our line of interconnects reveals increasingly numerous and thinner, individually insulated, solid annealed silver conductors in increasingly effective, field-controlling geometry's. This trend yields an increasingly precise sense of image clarity, transient speed and midrange neutrality.

Our standard line level cables are of the "nude" (unshielded) style, which has generally been perceived to sound "faster" and less "colored" than conventional fully shielded cables. As it turns out, there is good reason to think so since properly designed, un-shielded cables are much less reactive to the signal than their fully shielded counterparts. At audio frequencies and with reasonably short lengths of cable, a shield typically does more harm than good and is otherwise necessary only for Radio Frequency transmission and/or into extremely high gain inputs such as microphone and phono pre-amps. Instead, properly braided or twisted conductors effectively reduce susceptibility to induced noise, especially inductively coupled interference (EMI) while angular crossing weakens the field effects of opposite polarity conductors on each other. The mechanism for the self-shielding/field controlling design is to divide the signal into several separate runs in a continually changing orientation such that only a small fraction of either polarity is ever in the ideal orientation to the wave front. This has most relevance to electromagnetic fields either internal or external, which especially require an optimal angular component to induce the greatest opposing current flow.

Unlike many other audio cable companies, Silver Audio employs completely different and optimum designs for interconnect vs. speaker cables rather than using the same design interchangeably. Silver Audio publishes basic LC measurements for all of our cables to demonstrate the fact that each is designed specifically for the intended application and also that different designs do indeed result in a cable with a different and unique impedance.

## Silver Audio's White Paper

### 1. SCIENCE AT WORK, PERCEPTION AT PLAY

To the continuing frustration of mainstream electrical engineers and pragmatic curmudgeons alike, high-end audio cables remain a multi-million dollar industry. Fueling the controversy is the apparent irrelevance of standard transmission-line parameters, particularly, the "first order" effects of the LRC values of cables since they are virtually meaningless at audio frequencies, and especially for the relatively short lengths of cables used in a high end audio system.

In order to argue that the affects of different cables are indeed perceptible to a keen listener, it is necessary to make a few small leaps of faith, all which have a solid basis in fact: The first is that a keen and experienced listener can hear much less than the minimum, half power point, the 3dB convention and down to as low as perhaps one tenth of a dB. This was proposed by Fletcher and Munson nearly 50 years ago. The second is that the audible, albeit subtle sonic effects of different cables are an indirect result of other phenomenon such as the contributions of ultra-sonic frequencies, including harmonics, on the envelope of audio waveform.

It is likely that audiophiles are actually responding to very subtle phase shift effects that begin to show up in the upper reaches of audio well before gross frequency attention appears in actual measurements. In this light, by extending the audible limit of the audio spectrum to at least 100KHz and perhaps as high as half a Megacycle, things can begin to make some scientific sense.

## 2. HOW DOES ELECTRICITY CONVEY MUSIC THROUGH METAL?

Our precious music is electronically encoded in the form of a rapidly varying voltage over time, which would ideally be indistinguishable from the same pattern with which the original acoustic event modulated air molecules to produce sound. This voltage produces an electromagnetic wave that propagates through a conductive metal (wires) and causes the displacement of a shared surface cloud of electrons. People often speak of the movement of electrons (which is current) as the signal, which isn't quite right. In fact, the velocity of the signal is much faster (close to light speed) than the speed at which the electrons move. The fact that the signal does not travel at light speed is ultimately due to the reactive damping effects of the cable. The wave really travels through the conductor, displacing electrons much the way a wave, which is a non-physical entity (energy), travels through water. However, this is still an over-simplification as the exact details of signal propagation remain an enigma with no universally agreed upon complete explanation for the phenomenon. The true behavior is probably best explained by an interaction of both particle (matter) and wave (energy) properties similar to that of light conduction.

Most of the forces at work to counter the propagation of AC current (the signal) an audio cable are the result of the electric fields that form in and around conductors, and fall under the heading of proximity effects. Capacitance is a function of voltage therefore electrostatic in nature, and inductance a function of current, and therefore electromagnetic.

## 3. THE "SKIN EFFECT"

The distinction between the skin effect and self inductance may be a subtle to some, but not to those that truly understand the implications of the phenomenon. Contrary to the superficial propaganda parroted by the majority of the high end audio cable industry, the skin effect by itself is only relevant to very high radio frequencies (well beyond audio) and the all-too-often heard statement that "the high audio frequencies ride on the edge of the wire" is completely wrong. Only very high radio frequencies (Mhz) ride on the edge of a conductor. Therefore the "skin effect" has very different implications for the complex audio signal which consists of "bundles" of multi-frequency information spanning a very large range than it does for simple RF (radio frequency) carrier signals.

It is really the ORIGIN of the skin effect, self-inductance, not the skin effect itself, that can produce the group delay that is relevant to audio. The significance of self inductance to the audio signal is a gradient of differential resistance which has the potential to attenuate the power of the individual components of these multi-frequency "bundles" and thus introduce slight time delay's relative to each other. Otherwise, the end result of self-inductance, the "skin effect", is simply a rising DC resistance to rising frequency such that at highest frequencies (way up into the Megacycle range) DC resistance becomes so high (due to such a minute portion of conductive area available) that it becomes very significant and should be factored into impedance calculations to find the true impedance (resistance to alternating current). Normally, DC resistance of the conductor itself is dropped out of the equation for impedance for the "low to mid RF" range and is not a factor except for at AUDIO frequencies and very high Radio Frequencies.

The reason higher frequencies are continually pushed out from the center of the conductor to their ride depth (the "skin" of the wire) is due to a force, the changing magnetic field, which is produced by the rapidly fluctuating AC current. This force is a result of self-inductance which is a phenomenon resulting in the opposition to a change in direction of a signal (AC) due to locally circulating "eddy currents." Therefore, the deeper the frequency penetrates, the more it is damped, until it reaches an energetic equilibrium, which becomes its depth of penetration or "ride depth". This is analogous to the way quicker temperature changes penetrate a shorter distance into thermal-conductors than slower ones per unit of time.

This "skin depth" is often decided on from a common formula; (depth of penetration= $1/\sqrt{\text{frequency} \cdot \pi \cdot \text{magnetic permeability} \cdot \text{conductivity}}$ ) to calculate the depth to which, for example, a 20K frequency will penetrate.

From this formula one might mistakenly conclude that we only need to use a conductor whose radius is smaller than the depth of penetration of the highest frequency in audio (20 khz). Also, from this formula it is evident that Silver wires actually have an even shorter depth of penetration necessitating even smaller conductors than copper! This is because of the different conductive characteristics of Silver.

What is overlooked is how the depth of penetration formula was derived. In today's convenient formula based engineering world, there are many assumptions "built in" to all standard formulas, such as the 3dB, half power point in capacitance/resonance formulas. To calculate to what depth a given frequency penetrates is a function of to what degree the frequency is attenuated since it is a continuously increasing effect. The above formula actually yields the 1/e depth to which a frequency penetrates before it is damped to a 64% power loss which relates the shoulder of a sigmoid curve and thus normally a fair point to base further calculations on. We may calculate, if we want, the distance a 20Khz wave would penetrate before it is 99% damped which as you might expect, is greater. If however, we calculate the distance it can travel before it is only 1% damped, for instance, we find it is much shorter and well within the smallest conductor size used in virtually any audio cable! This formula is very conservative when applied to audio because it and others were originally derived for application in radio communication electronics where the skin effect is a vastly more serious problem due to the much higher frequencies (Mhertz and up to GHz) involved. Why should we allow any damping which is (in principle at least) a source of phase distortion when we can minimize it so easily by simply discarding with the ever present and almost universally untrue "bigger is better" "phalacy" (pun intended)?

In the light of all this, the sensible choice is simply to use conductors that are as small as possible to keep this gradient of differential resistance as short as possible which is why Silver Audio has always used multiple, very small, individually insulated conductors (the popular "Litz" concept) in place of one larger one. This is one of the two reasons we use two or more runs of the smallest feasible gauge pure Silver conductors in all our designs.

#### **4. CONDUCTOR SHAPE AND SIZE**

Several high end audio cable companies have created a unique marketing niche by using flat ribbon (usually just rectangular) shaped conductors as a way of combating the "skin effect" due to their thinner dimensions and supposedly reduced flux density at the center of the conductor. While this is more or less a valid concept, it is always propped up as being superior to ANY round conductor which is completely false. Of the few companies that attempt to bring science to their defense, ALL seem to have borrowed the same results from a misleading and very unfair comparison some years ago of ridiculously large diameter round conductors against very thin flat conductors when plotting DC resistance against frequency.

IF these results were real, this simple but otherwise clever experiment does illustrate what mathematics proved over half a century ago, which is that higher frequencies encounter greater resistance compared to lower ones since they penetrate into a conductor less and less with increasing frequency. However, this particular "proof" of the superiority of flat conductors is misleading since the effect can only be demonstrated with a huge gauge round wire that is so thick that the difference in depth of penetration of a 20k vs. 20 cycle tone is significant enough to measure. The point is that very thin round conductors (Silver Audio's specialty) compared to thicker flat conductors, would easily have the opposite result! Therefore, the decreased flux gradient of a flat vs. round conductor is at best, only valid when comparing equivalent gauge flat and round conductors. What make more sense and has MUCH more relevance to the skin effect as the AC phenomenon that it is, is to compare self-inductance between conductor types, and the trend is simple: Self inductance and thus the gradient of differential resistance, shrinks linearly with decreasing conductor cross sectional area down to a point where structural feasibility and the limits of measuring abilities end.

Silver Audio does not use flat conductors since they have major limitations in forming the complicated cable geometry's we use, and we feel they simply are not unconditionally superior to thin round conductors anyway. We also feel there is some question about the implications of a non-symmetrical flux gradient from the edge to center of a rectangular shape given the 3 dimensional, circular shape of the actual wave. Flat conductors can typically can only be arranged as all parallel, or with only a slight twist, or worse, in a very non-uniform bundle, but never in a rigidly symmetrical criss-crossed geometry that is especially important for a balanced cable to ensure that common mode noise rejection at the receiver is not compromised.

They also cannot be arranged in the tight packed orientation necessary to drive mutual inductance down to very low levels, which is a key requirement for top performing speaker cables. Lastly, using very thin conductors of ANY shape while failing to achieve a sufficient aggregate gauge results in DC resistance high enough to slightly attenuate very low frequencies. This is the stumbling point of the all too many cables that tout "ultra thin" as their primary accomplishment.

## **5. CAPACITANCE**

Capacitance is an energy storage phenomenon that is put to use in an audio circuit by separating a positive and negative charge between an insulator. Audio cables are prone to this phenomenon which also has the curious property of producing energy loss in the higher (audio) frequencies (depending on the total value of capacitance). Electrical energy in the form of a charge is stored in the dielectric (insulating material) and released quickly back into the signal path as the signal changes polarity. The phenomenon is used (along with inductors) intentionally in speaker crossovers for instance to divide different frequencies to different drivers, i.e. highs to the tweeter. The problem is this stored charge is released somewhat out of phase (slightly time delayed) to the main signal which is another small source of distortion. This is why no high-end audio pre-amplifier uses tone controls and also why higher order (i.e. forth order) capacitor-based crossovers filters are generally avoided.

The closer the proximity of and the more parallel the two "plates" as they are called in text books, wires in our case, the higher the capacitance. There are several simple solutions to minimize this problem; separate the conductors in space, and again use very small gauge wire since "plate" surface area is also part of the equation for capacitance. Notice length also adds to plate surface area, which is why excessively long cable runs are to be avoided. It is not practical to separate the positive and negative conductors so far that field effects are non existent since this will severely compromise the cables "self-shielding" capabilities. More importantly, this can upset the dynamic interaction between mutual inductance and self inductance, and allow self inductance to become very large.

To our alternating current, capacitance is actually a type of resistance since it opposes voltage changes. The degree of energy storage and subsequent time-delay relates to the "propagation velocity" inherent to different types of dielectrics and is expressed as the dielectric constant. This is of some interest since it is quite possible to have two identical values of capacitance as measured in Farads, but with very different values of propagation delay. Propagation delay is only directly relevant to very high radio frequencies but again, indirect effects of different responses to ultra-sonic frequencies on audio is the issue. In the introduction, it was suggested that if anything, it is subtle phase changes, not gross frequency attenuation of capacitance that keen listeners are responding too. Recall that the line level musical signal is mostly just rapidly fluctuating voltage. Transient information refers to the initial portion of this very rapidly changing information (particularly the slope of the change over time) and is a crucial aspect of realistic playback hence the slew rate of an amplifier; the speed with which it can deliver voltage changes in response to changes in signal voltage. For these reasons, it should be no surprise that capacitance whose first order effect only attenuates frequencies beyond the audio range (20khz) could be relevant to audio.

## **6. INDUCTANCE**

Inductance can also be also thought of as a type of resistance since it opposes changes in current direction and/or magnitude. When a signal changes direction or magnitude as it does in our interconnect cables, self-inductance tries to resist this change which is the origin of the skin effect. Conductor size is a crucial component of self-inductance. As mentioned in the previous section, there is a dynamic interaction between mutual and self inductance. In particular, under the right orientation, mutual inductance can partially oppose self inductance. Silver Audio considers this an important and completely overlooked aspect of cable design, and has some relevance in the context of speaker cables.

Mutual inductance refers to one conductor's effect on the other and is also Electro-magnetic in nature, a function of current. The current moving in one conductor produces an electromagnetic field that tries to couple with and produce current flow in the opposite direction in the other conductor. This is the principle behind the electric motor hence the term EMF (electromotive force). Here, geometry becomes important. Steep angle crossing of opposite polarity conductors is the best way to weaken this coupling effect when that is desired.

Inductance is considered less of an issue with the line level signal than with speaker cables since the voltage to current ratio is much higher. This is also because the typical values of inductance of an interconnect are much lower in magnitude compared with typical capacitance values when compared to the values of inductance and capacitance used in a tone network that DEFINITELY make a pronounced difference.

## 7. WHY SILVER INSTEAD OF COPPER?

Technicalities aside for the moment, properly designed Silver audio cables are found supremely pleasing for their lush, vivid, and above all, natural presentation. Pure Silver wiring harnesses and even transformers are the choice of many cost no object amplifiers and loudspeakers. However, just because Silver is used as a conductor does not, unfortunately, make a cable a good performer. As explained earlier, Silver is more prone to phase shift than copper due to its greater potential for group delay as a result of its different magnetic permeability and ironically, its greater conductivity. Therefore, it is crucial to use even thinner conductors than one would with copper to nullify this limitation.

An important benefit to the use of Silver is freedom from the diode-like, energy storing and distortion producing effects of its oxide (compression and other non-linear effects). This is because Silver Oxide itself is such a superior conductor. Copper Oxide on the other hand, is a semi conductor, a material a rectifier could be made of! Copper Oxide occurs at the molecular level and is the reason behind the fanatical effort expended to attempt to make "OFC" (oxygen free copper) which is not 100% possible. Copper Oxide only gets worse with age especially with repeated bending and twisting.

## 8. WHAT MEASUREMENTS TELL US (NOT MUCH)

Because of DC and AC resistance, the "sound" of a cable is really defined by how it alters the interaction between the source and load components. AC resistance (impedance) is the result of both capacitive and inductive effects (reactance) and is far more relevant than DC resistance however. AC resistance is perhaps the main source of the "voodoo" of audio cables since a given cable design will in principle cause different audio equipment to "behave" differently due to the substantial variation in both input and output impedance's of preamplifiers, power amplifiers, and front end units.

The "voodoo" reputation of audio cables is worsened by the apparent irrelevance of typical steady state measurements. Educated "cable cynics" are fond of pointing out that calculated frequency effects (3db down!) of the capacitive and inductive values of any normal audio cable at normal lengths are much higher than any audible frequency. This simplistic argument implies that that such delicate, complex and highly variable sonic qualities affected by different audio cables (or amplifiers for that matter) such as sound stage depth, image focus and ambience could be completely explained by simple frequency attenuation. Indeed persistent attempts by solid state designers to clone the very unique manner in which vacuum tubes affect the audio signal by using simple tone networks have always been a laughable and dismal failure.

While the "first order" effects of LC influenced frequency attenuation are well characterized, indirect effects of their time delay components on our perception of the more subtle aspects of playback are not. One or two degrees of phase shift can be calculated in the audio band from capacitance whose frequency attenuation is well into the ultra-sonic regions. Exactly what one degree of phase shift and perhaps one tenth of a dB of attenuation may sound like is not known and is probably very unpredictable and extremely dependant on the particular source material. Such small effects could not normally be seen since they would be hidden in the noise floor of measuring equipment. Instead actual their existence can only be suggested mathematically.

The fact that different audio cables do affect system performance differently would be especially challenging to defend if all audio cables had identical LC measurements. Luckily, this is not the case, as different interconnect and speaker cable designs result in easily measurable variations in capacitance and inductance respectively. Aside from the resulting differences in phase shift by degree, placed into the big picture of impedance, seemingly modest differences in LC measurements calculate to substantial differences in impedance (frequency variant) and characteristic impedance (frequency invariant) especially with speaker cables. Measurable differences in amplifier damping (which produces a rainbow sonic aberrations to the listener) have been easily demonstrated with different speaker cable designs, all of whose direct effects on frequency response alone should have been inconsequential! Furthermore, with the exception of digital cables, no audio interconnect or speaker cable can be terminated in their exact characteristic impedance, a condition that theoretically results in 100% power transfer (zero power loss).

Therefore, all audio cables create some degree, though very slight, of so called "mismatch reflections" between source and load. It is then reasonable to assume that audio cable designs that happen to come closer to an ideal impedance should in principle reduce these distortions.

Other possible reasons are the effects of inter-modulation distortions caused by varying susceptibilities of different cable designs to low frequency interference and the nature of unique "beat frequencies" generated when higher frequencies react against lower ones (heterodyning). The former is strongly a function of geometry since conventional shielding alone cannot block very low frequency EMI. The latter is especially appealing since most exotic audio cables measure differently enough that their response to ultra-sonic frequencies (generated as harmonics of amplification stages themselves) would vary substantially as well.

When the complexity of each of these phenomenon's alone are considered against the staggering complexity of a real musical signal at the "quantum level", it is clear we are a long way from being able to truly understand the electronic behavior of any audio equipment under "real life" conditions. Thus the effects of high performance audio cables remain among the purest demonstrations of the limitations of the study natural science; which is the disparity between the naturally occurring phenomenon and the measured, simulated version of reality.

## **FAQ:**

### **1. SILVER AUDIO'S INTERCONNECT SELECTION CRITERIA**

Moving up our line of high performance interconnect cables reveals increasingly numerous and thinner, individually insulated pure silver conductors per polarity. This highly functional trend becomes ever more revealing with an increasingly precise sense of image placement, transient speed, and midrange neutrality. The degree of midrange emphasis is the crux of virtually all controversy in high-end audio and is simply a matter of personal preference, not something anyone "has" to like one way or the other! Silver Audio is happy to assist you with honest, system matching advice independent of your budget. If we think our least expensive cable would be most appropriate for your system, we'll tell you!

### **2. How pure is your silver? (The "ultra-pure hoax revealed")**

The shameful practice of claiming ridiculous and completely impossible levels of silver purity by various "high-end" audio cable companies has gone on long enough. Silver Audio formally challenges ANY high-end audio cable company claiming to use greater than 99.99% pure silver to PROVE their claim by making available, a notarized copy of their certification analysis including the name and location of the INDEPENDENT laboratory as well as the type of testing method that was used.

When we demanded proof from our FORMER vendor of their claim (to us) of "five-nines" pure (99.999%) silver, they were unable (and unwilling) to provide it. When another potential vendor claiming "six-nines" pure (99.9999%) stopped communicating with us after we demanded proof from them as well, that was when we became very suspicious that claims of six and even "seven-nines" (and still higher!) were nothing but blatant marketing fraud. In some cases, honest ignorance appears to be the reason behind some claims of ultra-high purity. In most cases however, desperation for a unique selling point is obviously the motivation!

In two years of dealing with scores of the same testing labs that certify metal purity for the aerospace and medical industries (where purity REALLY matters) we find over and over again the same result: There is NO testing method, not even ICP mass spectrometry, and most importantly, no clean room or handling procedure capable of reliably and repeatedly assaying any element beyond 99.99% pure. Even the silicon used in the semi-conductor industry (by some of the most critical and sensitive equipment in the world) cannot be assayed for purity beyond 99.99%! Some audio companies have, perhaps only naively, tested their metal only for gas impurities (oxygen) which is expressed in parts per million (ppm) and apparently tried to then express this figure as a percent of purity (by weight or volume?! This conversion makes no sense and even if it did, the real contaminants of silver are not oxygen, but the trace elements of iron, copper, phosphorus and silicon!



Silver Audio does not purchase any lot of silver that does not test to 99.99% pure ("pure" silver is often less than 99.99%). Each lot is certified by an independent lab for ALL trace impurities by weight, DC resistance and ductility. The certification for each new lot is notarized and provided to Silver Audio and is available to anyone who requests it, though it is intended for our OEM customers who buy our wire. The only aspects of purity that we pay some attention to, since they MIGHT account for some performance difference, are the relative levels of silicon and copper. Otherwise, what really matters (and is measurable) is the method by which the wire is drawn and to what final temper. Silver Audio does use a very simple (but to our knowledge unique) trick in conjunction with well maintained, very high tolerance diamond dies to ensure an exceptionally smooth, dense, and clean final product. **Otherwise, the lesson here is that what really matters is the cable design and how it is executed, not whether the conductors are 1/10,000 of one percent less pure than those of another brand of cable!**

### **3. WHY ARE MANY CABLES MADE WITH SILVER PLATED COPPER INSTEAD OF SOLID SILVER OR BARE COPPER?**

Eager to cash in on what is perceived as an easy and lucrative business, part-time hobbyists posing as "cable companies" continue to flood the internet and classified adds with "sensibly priced", home-made silver cables. Prospective buyers need to read advertisements very carefully since it is often not very apparent that many of these "bargain silver cables" are actually only made with silver plated copper wire, not solid silver. Often slyly advertised simply as "Silver cables", vague and misleading terminology has been created to give the impression that some groundbreaking, exotic manufacturing process has been invented, such as "silver saturation", "silver-clad", "silver hybrid" etc.

The reality is silver-plated copper wire is simply a mass produced staple of the commercial cable industry, and readily available at any surplus electronics outlet or parts catalog. It is far less expensive than Teflon co-extruded solid silver wire which is only produced on an individual basis for high-end audio cable companies that can afford it. Silver or tin plating is simply used to protect bare copper from heat/chemical accelerated oxidation. Silver is used instead of tin for high temperature applications, or to boost the conductivity of braided shielding material. In contrast, the pervasive use of silver-plated copper conductors in high-end audio (and especially "low-end" audio) is never for any other reason than to seduce naïve consumers with the infallible reputation of pure silver as for a signal conductor.

No valid SONIC advantage can be claimed for silver plated copper wire at audio frequencies. If anything, arguments could be better made for a sonic DISADVANTAGE of silver plated copper! Learning and understanding a little bit about the crucial differences between the nature of audio and RF (Radio Frequency) signals reveals the reasons why.

Very high frequency RF signals (from MHz and beyond) propagate very differently than audio. Due to their very shallow depth of penetration, ultra-high frequencies only travel around the very edge or "skin" of a conductor and are incapable of penetrating into the conductor more than 1/1000 of an inch or so, and less at even higher frequencies. Thus ONLY radio frequency signals (RF) can benefit from a thick plating of silver over a solid conductor of different metal. In this case, the superior conductivity of silver partially compensates for the phenomenon of rising DC resistance to rising frequency (the constantly misunderstood "skin effect").

Only two other valid electrical uses for silver plating exists; at connector contact surfaces and to boost the conductivity of braided mesh shielding material used around coaxial type cables. The later increases shielding efficacy by lowering transfer impedance. It was only a matter of time before this inexpensive and common material found its way into a few high end audio cable designs where it is used as the signal conductor!

At audio frequencies however, any effect silver plated conductors (not connectors) MIGHT have on the signal could only be bad. At audio frequencies, otherwise small differences in simple DC resistance significantly alters impedance. Therefore, the presence of both silver and copper in the signal path is capable of creating two different, frequency dependant, conductive pathways to the signal which is a non-linearity that NO audio cable should be causing, especially not a "high-end" audio cable!

In the case of silver plated connectors however, the benefits far outweigh the theoretical limitations of silver plating by reducing contact resistance. Contact resistance can be a source of subtle distortions due to arching and especially RF demodulating diode-like effects.

#### **4. WON'T EVEN THINNER CONDUCTORS FURTHER IMPROVE SILVER BULLETS?**

We tried, and it didn't work! The wire diameter used in the Silver Bullets 4.0s and 6.0s (XLR) has been carefully chosen for the perfect balance between frequency balance and detail. Naive listening tests confirmed diminished deep bass energy when we tried to further reduce wire diameter on the Silver Bullets. While "thin conductors for thin bass" sounds simplistic, this is indeed the case since the heavier current demands of lower frequencies require less resistance for equal perceived volume levels. Therefore, to push our thin conductor method to its practical limit for even greater image resolution without impairing bass response, it was necessary to develop a different and more complicated eight conductor design; our newly released Appassionata interconnect.

#### **5. WHAT DOES YOUR LOGO MEAN?**

Our logo was chosen as the traditional Chinese character for "Listen". The character contains the symbols for the ear and the heart with the literal and very appropriate translation that we "Listen Through Our Heart".

#### **6. A QUICK WORD ABOUT ALL OUR CABLES?**

It is important to understand that our cables cannot "fix" poor recordings or inferior equipment. If your system has flawed or limited frequency response, neither our cables nor anyone else's can restore corrupted information! Furthermore, if you have tried cable after cable and are still unhappy with the performance of your system, chances are you are not coming to terms with an unpleasant (and perhaps very expensive) sounding component in your system. Audiophiles sometimes turn a blind eye towards problematic audio components mistakenly believing they can, for instance, pair overly bright sounding audio cables with a lifeless amplifier and achieve a "perfect match".

Conversely, many pop recording studios EQ recordings to reference equipment that is grossly inferior to that of most Audiophiles! The unfortunate reality is there are vastly more mediocre to atrocious recordings than superb ones. Clearly (no pun intended) a high-resolution system is a "double-edged sword". However, by virtue of extremely low induced distortions and balanced frequency response (unlike many of today's "trick" audio cables) the "holistic" approach to cable design favored by D Lin's Silver Bullets allows the most pleasing possible sound to be conveyed from all sources.

#### **7. WILL SILVER CABLES SOUND TOO BRIGHT IN MY SYSTEM?**

The bulk of the "Silver is bright" misperception probably originates merely from visual cues incorrectly translating the sight of a bright, shiny conducting element to a "bright" "shiny" sound. This rather pervasive and mostly unjust reputation is only coincidentally supported by a few, poor quality or otherwise ill conceived cable designs that use Silver plated copper wires or inappropriate grades of Silver for audio applications. The poor choice of Silver-plated copper wire does have a reputation for producing an irritating sort of ultra-sonic ringing.

Otherwise, one of the hallmarks of solid core, pure Silver audio cables i.e. the Silver Bullets, is one of endearing smoothness. With regards to the electronic properties of Silver, an improperly designed, pure Silver cable would actually be more likely to sound too smooth! (The later would be caused by using excessively large gauge Silver wire).

#### **8. WHY ARE YOUR CABLES SO EXPENSIVE?**

We compete against the highest quality audio cables on the market, not the worst! Our designs involve production costs that are necessary to produce a consistently top quality cable with a specific design goal. While some scoff at the \$900.00 and up audio cables that dominate the market, any claim beyond basic function for a \$60.00 generic coax audio cable should be regarded with far greater suspicion!

Most importantly, the diminutive high-end audio market is simply not a volume driven industry. High-end audio products are high-performance luxury items (usually) that cannot be made available to the bottom end of the market.

## **9. WHY ARE YOUR CABLES SO CHEAP?**

As a primarily manufacturer-direct business, the suggested retail price required to accommodate the dealer commission (typically as high as 50%) is eliminated from our price structure. The few select dealers we may enlist in the near future will be a parallel effort to our own and will mostly serve the purpose of increasing our market exposure. We are fortunate to be able to operate Silver Audio on a lower profit margin than other larger companies. Manufacturing accounts with OEM suppliers of our raw materials yield decent price breaks while our cables are made in smaller numbers at time by our own technicians, thus allowing a very efficient "demand flow" system with inventory.

## **10. SHOULDN'T I JUST FIND THE LOWEST CAPACITANCE CABLE I CAN FIND?**

It would be nice if this were the only consideration that mattered in audio cable performance. While most serious listeners would probably prefer a 40pf cable to a 150pf cable in their system, other factors vary considerably such as noise rejection abilities, skin effect losses, conductor purity and termination/connector quality. Only audio cables that properly address all these topics simultaneously should be worthy of consideration.

## **11. DO YOU USE "TRUE 75 OHM RCA CONNECTORS" FOR YOUR DIGITAL CABLE?**

The audio cable industry has always been notorious for generating absurd misinformation ("true lies") which quickly becomes part of the vocabulary of naïve marketing departments, consumers, retailers, and even technicians and audio designers themselves.

With its inherent capability for uniform conductor spacing, a standard coaxial-type cable (center conductor surrounded by tubular shield/ground) can be designed to create a specific impedance (total true resistance to alternating current). This is accomplished by manufacturing the cable with a specific calculated distance between the signal carrying center conductor and the negative/ground outer conductor. The dielectric constant of the insulation and diameter of the center conductor must be factored into this calculation as well. Manufacturing a tight tolerance cable of specific impedance is no trivial feat and deviations of even less than a millimeter in conductor spacing will ultimately result in a different impedance over distance. This is why a "handmade" cable should NEVER be used as, nor claimed to be, a 75-Ohm digital cable! This is also why many claimed 75-Ohm cables wind up not being 75 Ohms (sometimes far from 75 Ohms) since low quality multi-stranded type center conductors and soft PVC type insulation are unable to maintain sufficiently rigid spacing during manufacturing and in use after repeated bending and twisting.

Thus, the only way a "true 75 Ohm" RCA connector could possibly be made would be by the same method. This would be completely impossible for many reasons, not the least of which is the smaller distance from center conductor to shield/ground in a 75-Ohm cable, as well as the much smaller diameter of the signal conductor. If the normal spacing between the pin and shell of the male RCA connector, or the diameter of the center pin were altered at all, the connector would then be unable to fit onto the standard female RCA terminal! If we think some more, we realize the distance from the pin to the negative, outer barrel portion of the female connector (on the chassis) would be the same regardless, since the pin is INSIDE the female connector when plugged in! If we continue thinking we also realize the spacing from the center conductor of the "stripped" portion of the cable to the body of the connector would have to be exactly the same at all points, which is also impossible in practice. This leads us to the next important topic:

## **12. WHICH IS BETTER FOR 75-OHM DIGITAL CABLES, RCA OR BNC CONNECTORS?**

The use of RCA connectors for digital audio has developed a bit of a bad reputation. This is partly due to the fact that BNC type connectors have always been standard everywhere else in the industry for RF applications, and mostly due to the above misunderstanding about the impedance of the connector itself. Due to stricter manufacturing tolerances of the male and female terminals however, BNC connectors can make a more secure electrical connection than SOME RCA connections, and thus are preferable when there is a choice.

# Transparent Cable

Tech Talk: Detailed technical information for your reference

## Part One: Why audio cables need a network



### Cable Construction and Audio Cable Performance

Flat cables with parallel members typically have the highest propagation speeds and the widest bandwidth with some of them passing signals freely into the gigahertz region. Coaxial cables are also relatively high propagation speed, wide bandwidth designs. Flat and coaxial cables are the designs of choice for digital and radio frequency transmission. When these extremely wide band cables are used for audio applications, however, they are particularly subject to noise infiltration along the entire length of the cable, much like an antenna.

Flat and coaxial cables are particularly subject to noise infiltration along the entire length of the cable, much like an antenna.

The standard ways to approach noise infiltration are through shielding and twisted pair technology, both of which limit cable bandwidth to an extent. Good shielding will reduce electrostatic (ES) noise infiltration. A twisted + and - pair will theoretically prevent electromagnetic (EM) noise infiltration by nulling out these noise frequencies. Cables that employ these geometries will still pass signals freely into the 100 megaHertz region and beyond, however, which is far more bandwidth than what is required for audio applications.

In reality, however, twisted pair technology only goes part of the way toward cancelling out EM noise because the proximity of the twisted + and - pair is never identical over the whole length of the cable regardless of how carefully the cable is manufactured.

To reduce EM noise beyond what can be achieved through twisted pair technology requires a properly designed network fitted to the specific application and the length and type of cable. Transparent interconnects are well shielded and both speaker cables and interconnects have twisted pair technology. Our networks clean up any residual EM noise not addressed by twisted pair technology by reducing the bandwidth of the cable to that which is required for the application. Limiting bandwidth to that which is required for the application is a basic audio engineering principle that is adopted in every other component category — speakers, amplifiers, CD players, phono cartridges, etc.

Limiting bandwidth to that which is required for the application is a basic audio engineering principle that is adopted in every other component category — speakers, amplifiers, CD players, phono cartridges, etc.

Noise infiltration obscures the ability of the cable to transfer extremely low level harmonic and spatial information accurately, and it has a tendency to make the system sound brighter and harsher in the high frequency region than what is recorded on the source material. Increased noise floor directly affects our ability to perceive full dynamic range and all its gradations.

### The Role of Inductance and Capacitance in Audio Cables

Inductance and capacitance need to be carefully controlled in cable. Too much or too little of either characteristic will provide undesirable results. Flat cables, coaxial cables, and even twisted pair cables without networks exhibit electrical characteristics that are not in the best interest of music for several reasons. In lengths suitable for most home audio systems, these cables have too much bandwidth for audio applications and are particularly subject to noise infiltration. Another problem is the point at which these cables achieve electrical resonance; i.e., the point at which inductive reactance equals capacitive reactance.

Cables with extremely wide bandwidth create a thinner and brighter sound than cables with less bandwidth.

We have tested a wide variety of flat cables, coaxial cables, and twisted pair, nonnetwork designs on high speed gain phase, impedance analyzers in our laboratory. When we fit the analyzer with a typical audio source impedance to drive such cables into a typical audio load impedance, the point at which these cables achieve resonance falls somewhere between 1500-2500 Hz (depending on the specific cable and its length). This means that such a cable becomes more capacitive at frequencies below 1500-2500 Hz, thereby resisting the transfer of frequencies below 1500-2500 Hz. Twisted pair cables typically have a lower resonant point (usually in the 1500-2000 Hz range) than flat or coaxial designs.

It takes a \$ 70,000 piece of equipment, the engineering wherewithal to set up the test properly, and 3-4 hours of "crunch" time per cable to get the data necessary to correlate our conclusions about a particular cable's resonant behavior under audio load conditions. During our 14 years as a cable company, we have listened to and tested hundreds of different types of cables. Cables with extremely wide bandwidth create a thinner and brighter sound than cables with less bandwidth. We think this condition is primarily caused by too high a resonance.

Customers, recording professionals, and many fellow manufacturers gravitate to Transparent Cables because they are more able to reveal all the fullness, richness, and dynamic quality of the music as it is recorded.

A serendipitous effect of limiting the bandwidth of Transparent Cable with a properly designed network is a lowering of the resonant point, or that frequency where the cable becomes more capacitive and starts to resist low frequencies. In our experience, the sonic byproduct of lowering the resonant point is that music fundamentals and lower order harmonics seem to be passed in the correct proportion to each other and their higher order harmonics. The musical balance is correctly weighted around the two octaves surrounding middle C. Customers, recording professionals, and many fellow manufacturers gravitate to Transparent Cables because they are more able to reveal all the fullness, richness, and dynamic quality of the music as it is recorded.

### **The Role of Group Delay in Cable Design**

The propagation speed of frequencies will be delayed to one degree or another in any cable. The critical concept regarding propagation speed in cables designed for audio applications is that all frequencies should be delayed the same amount of time (uniform group delay). This means that if different frequencies enter the cable at the same time, they should leave the cable at the same time. Many cables without networks and well designed cables with networks have excellent uniform group delay characteristics.

The extremely fast propagation speeds touted by some manufacturers of extremely wide band cables are really not any measure of musical satisfaction.

Wide bandwidth and extremely fast propagation speeds usually go hand in hand. The inductance of cables with less bandwidth usually is sufficient to reduce overall propagation speed, but if the cables are designed properly, the delay in these cables should be uniform over the usable bandwidth of the cable. The extremely fast propagation speeds touted by some manufacturers of extremely wide band cables are really not any measure of the musical satisfaction users will derive from inserting such cables in their audio systems because of their higher resonant points and susceptibility to noise infiltration.

These conditions result in sonic byproducts that are not in the best interest of retrieving all possible musical information from records, CDs, and tapes. The energy balance of audio signals transferred on cables that have higher resonant points and susceptibility to noise infiltration is shifted above the octaves surrounding middle C. The hyperarticulated effects of this energy balance get the listener's attention initially. This hyperarticulated balance has become a hi fi standard in itself, particularly among those hi fi enthusiasts whose focus is on the equipment itself and the various effects that can be achieved by inserting different pieces of equipment in an audio system. Over time, however, this type of sound does not wear well in the ears, minds, and hearts of those looking for a more musical connection in their audio experiences.

## **The Effect of Cable Length on Bandwidth and Resonance**

An extremely short cable without networks will have wider bandwidth than a longer cable of the same type because the shorter cable will have less inductance and capacitance. As discussed earlier, extremely wide bandwidth cables are subject to noise infiltration and resonant behavior and sonic byproducts that do not serve music. Extremely short cables without networks will sound more alike than they will sound different because of their similar bandwidth and resonant characteristics. In our opinion, they will tend to transfer an audio signal so that it is more like a hi fi experience than it is a musical experience.

Contrary to popular opinion then, shorter is not necessarily better from a musical standpoint. In cables without networks, a longer cable will tend to sound less bright and fuller because it will have more inductance and hence less bandwidth and a lower resonant point than a shorter cable.

The same sonic pitfalls that apply to the "shorter is better" perspective, also apply to "Cable Comparator" tests. From an electrical perspective the cable comparator behaves like an extremely short piece of cable. In other words, the cable comparator will have extremely wide bandwidth and will have a relatively high resonant point. A typical cable without a network will most closely resemble the electrical characteristics of the cable comparator than will a cable with a properly designed network. It also follows that the shorter the piece of cable, the more it will resemble the sound of the comparator. The basic premise of this comparison is based upon an assumption that a short cable is better from a musical performance perspective which as we have discussed earlier, is not the case at least from the point of view of our extensive tests and listening.

## **The Ideal Cable Length for Audio Applications**

There is, in fact, an ideal length for any type of cable which will establish the proper relationship between capacitance and inductance; i. e., ideal bandwidth and a resonant point that is as low as possible for the application. If this specific "ideal" length of cable is compensated properly in its natural roll-off region with a network, it will exhibit very uniform group delay characteristics throughout its entire usable bandwidth; i.e., phase, imaging, timing of harmonics to fundamentals, etc. will be true to the source.

Extremely short cables without networks will tend to transfer an audio signal so that it is more like a hi fi experience than it is a musical experience.

Every Transparent Cable regardless of length (with the exception of inordinately long cables) is tuned so that it achieves the same electrical characteristics as an "ideal" length of cable for the application, and then it is properly compensated in its roll-off region to achieve uniform group delay characteristics. We optimize interconnects longer than 35 feet and speaker cables longer than 25 feet to sound extremely wonderful in their own right. Extra long Transparent Cables will definitely have a performance edge over uncompensated extremely long lengths of cables.

Because we typically use a variety of different lengths of cables in today's complex audio and video systems, our musical interests are better served by choosing cables that have all been tuned to achieve the electrical characteristics of an "ideal" length of cable. If music is the priority, then Transparent Cable has to be the choice.

## **Part Two: Materials, geometry, soldering techniques**

### **Strand and Conductor Technology**

Conductor material should be pure and consistent, and the conductor surface should be smooth and uniform for best signal transfer. In our opinion, pure silver conductors do not possess inherent qualities that make them a better conductor of music range signals than copper conductors. For audio applications, pure silver will usually require more compensation than many copper conductor configurations, and the cost of pure silver is exorbitant.

The conductors in Transparent Cables consist of many strands of single gauge, precision extruded, oxygen free copper. Each strand is annealed to provide an extremely smooth and uniform surface. The strand bundles are precisely wound around a center core of dielectric.

### **Dielectric Materials**

Precision extruded teflon has superior dielectric insulation properties compared to just about any other material except air, but cables with sufficient air insulation would be very bulky and difficult to manufacture with consistent results. Teflon works very well on interconnects which require a relatively thin layer to insulate them properly, but teflon insulation would result in a very stiff and difficult to use speaker cable.

Transparent Interconnects have teflon insulation, and Transparent Speaker Cables have polypropylene insulation. Polypropylene has nearly the same excellent insulation properties as teflon, but it is a lot more flexible in the quantities required for proper speaker cable construction. Laser micrometers insure even dielectric extrusions on all Transparent Cables.

Every Transparent Cable regardless of length is tuned so that it achieves the same electrical characteristics as an IDEAL length of cable.

### **Cable Geometry**

As discussed earlier, twisted pair technology results in superior audio range performance because of the nulling effect of + and - conductor proximity. Many audio cables provide twisted pair technology. The precision and consistency of the twists are very important to achieving as much nulling as possible and to insure that any two sections of cable of the same length will exhibit the same relationship of inductance to capacitance. The cable jacket must be tightly and precision extruded around the twisted pair to hold the twisted pair firmly in place. The tight jacket insures that cables will maintain their intended electrical characteristics even when the cable is flexed or bent as in home audio installations.

Transparent Cables consist of twisted pairs that are precision machine wound to our exact specifications. Cable jackets are pressure extruded to hold conductors firmly in place when the cable is bent or twisted. Transparent Cables have amazingly consistent electrical characteristics from sample to sample. They also exhibit rock solid electrical characteristics when they are bent or twisted. These manufacturing techniques allow us to fit every performance level and length of Transparent Cable with a precision designed network that will result in the same high standards of musical performance from application to application.

### **Soldering Techniques**

We do not use solder pots or extremely hot soldering irons to construct Transparent Cable. We carefully temper the strands in each conductor with heat controlled soldering irons, and we use only enough heat to flow high purity 2% silver solder. Out of the many soldering techniques we have tested with time delay reflectometry, our heat-controlled methods seem to provide the best signal transfer results.

Transparent Cables have amazingly consistent electrical characteristics from sample to sample.

## **FAQ**

### **Q: What happens when I move up to the next level of Transparent cable?**

A higher level Transparent interconnect and speaker cable will lower the noise floor of your system. This will allow you to hear a whole new level of soundstaging and ambience from your favorite recordings, along with better resolution of rhythmic, dynamic and harmonic nuances. You will also notice a significant improvement in midrange and bass response.

### **Q: What is the XL technology?**

The XL technology is a computer model that specifies the exact electrical parameters needed for an audio cable to achieve ideal musical performance, given its geometry, length and application. This technology is the culmination of many years of research, testing and critical listening. We first used the XL technology to design the Reference XL speaker cables and interconnects. Later, in 1997, we used it to improve our entire line of networked cables.

### **Q: How long will it take for my cables to break in?**

Transparent cables need about 100 hours of burn in time before they start to perform their best, and they will continue to improve for up to 200 hours. Initially the upper midrange and treble frequencies may sound slightly forward and harsh. After break in the treble frequencies will relax to natural levels and the bass frequencies will become more controlled and extend into the lower octaves. Dynamics will also bloom more freely.

### **Q: I want to buy Transparent cables for my system, but I can't afford to upgrade all of my cables at once. Which cables should I upgrade first?**

When upgrading with Transparent cables it is usually best to start at the source. Upgrade your interconnects first, starting with a Transparent Digital, Phono or line level interconnect, and then upgrade your speaker cables. The link between preamplifier and amplifier should be the last step in completing your Transparent signal path.

Consult with your dealer to determine the best upgrade path for your system. We recommend that you borrow a complete set of cables from your dealer, even if you plan to upgrade your cables in stages. This will allow you to hear what a fully "Transparent" system sounds like, and eliminate any interactions with other cables in your system.

### **Q: Will it degrade the sound if I use a long speaker cable or interconnect in my system?**

Not at all! We compensate for cable length with our networks so a long cable will sound the same as a short cable and vice versa. We design a different network for every length of Transparent cable so you can set up your components where you want them and not have to worry about a loss in performance.

If you have a passive volume control for a preamplifier, or an extremely high output impedance preamplifier or amplifier, you should consult with Transparent for advice regarding cable length and type.

### **Q: What is the difference between a balanced interconnect and a single-ended interconnect?**

Transparent balanced interconnects, like balanced amplifiers and source components, use common-mode noise rejection to transfer the musical signal with less noise interference. In a single-ended circuit there is a positive and a negative, and the negative also acts as the ground. In a balanced circuit there is a positive signal, an inverted signal, and a separate system ground. There are several advantages to a balanced design: ground noise is kept separate from the audio signal, and the symmetrical design naturally cancels EMI and RFI noise.

Our balanced interconnects are completely different from our single-ended interconnects. Each Transparent balanced interconnect has three conductors (positive, inverted, and system ground), a separate shield, and two matched networks: one for each signal carrying conductor. Our single ended



interconnects have two conductors, a shield, and one network. Many of the "balanced" interconnects on the market are really single-ended cables with balanced (XLR) connections.

**Q: My system has both balanced (XLR) and single-ended (RCA) connections. Should I use a single-ended interconnect or a balanced interconnect?**

Use Transparent balanced interconnects between your balanced components to take full advantage of their expensive balanced circuits. The balanced connections will lower the noise floor of your system and you will hear significant improvements in dynamics, soundstage and low-level resolution. Buying balanced components and connecting them with single-ended cables is like buying a 5-speed car and only using the first 3 gears!

For connections between balanced and single-ended components use a Transparent single-ended interconnect. There is no benefit to be gained from using a balanced interconnect with a single-ended component. Instead, you should use a higher level Transparent single-ended interconnect.

**Q: Should I use the Transparent Biwire or BiCable speaker cables with my biwire speakers?**

Transparent Biwire speaker cables are the same as our single-wire speaker cables except they have four connection leads on the speaker end for biwire speakers. This configuration gives each section of the speaker system a direct connection to the network.

The Transparent BiCables, on the other hand, have two cables within a single jacket and two separate networks within a common module. This configuration gives each section of the speaker system a direct connection to the amplifier, via its own dedicated network. Because of the extra cable and network the BiCables are more expensive than their Biwire siblings.

Ask your dealer for the best Transparent speaker cable to use with your biwire speakers. Many biwire speakers will benefit more from a higher level Transparent Biwire, over a lower level BiCable at a comparable price. The higher level Biwire has a more advanced network that will provide better resolution and a more natural tonal balance. Some speakers, however, are specifically designed for biwiring and will work better with a Transparent BiCable.

# The Music Cable

We believe with the modern day huge increase in the use of telecommunications and electronic equipment, we need the best shielding to protect our music from these intensifying storms of EMI and RFI interferences. Older designs of Hi Fi cable shielding method may fast become inadequate in providing the kind of protection needed nowadays, especially in the densely populated busy cities. We need the best shielding than ever before, for all our interconnects and speaker cables (especially the part that carries the high, and mid-range signals). Solid copper shielding offers the best EMI and RFI shielding. Precision made locking type plug offers the best grounding - together these designs protect the music from outside interferences. The use of best quality foam-air bonded dielectric, and single solid copper clad aluminium conductor, preserve signal integrity from the inside, as it travels down the cable. By design, we offer one of the best (if not the best) Hi Fi cable system for modern day use. Noises that you don't even notice before, together with some of the distortions that you used to blame your amp or your speaker for, will be gone.

If you have not used a cable with solid copper shielding before, we invite you to share the joy of using our cables. All our cables carry a 45-day money back guarantee so you can relax and let your ears and heart be the critics. Please go to our products page for details. You will find these cables very quiet, very precise, very neutral, and extremely detailed and real sound stage.

Our cables put the life back into the music.

## Frequently Asked Questions

### Is the cable directional?

The design of the cable is not directional. But to keep the beneficial effects of burn-in, the cable is marked with an arrow (see the lightning strike under the TMC logo) indicating the flow of the music signal.

### Is the cable stiff?

The cable can be considered stiff when compared to most other commercially available Hi Fi cables, but the cable is very manageable. Follow the simple steps below; take a little time to connect the cable, then sit back and enjoy the music with TMC like you have never before.

Please note: "Remember to remove the cable before you shift the equipment around."

### How do you install the the cables with locking type RCA plugs?

Out of the box, gently straighten the cable into a more manageable general shape to work with.

Bend and shape the cable into position, with the RCA plugs pointing square and straight at the RCA sockets.

Turn the barrel (with color code rings) of the plugs anti-clockwise to loosen and un-lock the plug just enough that the plug can be pushed fully into the socket.

Plug in one side of the cable. Make sure the plug is pushed all the way into the socket.

Turn the barrel clockwise to lock the plug onto the socket.

Note: Push the plug further into the socket, every 1/2 turn of the barrel while locking down, or as soon as you can see a gap between the tip of the barrel and the socket, before further tightening.

The final lock down should not take more than 1/4 turn of the barrel, and the tip of the barrel should be almost touching the socket.

Now carefully re-shape the cable so that the other RCA plug can go straight into the other socket without much strain from the cable. Repeat steps 3 - 5.

Important: Always remember to loosen the barrel to unlock the plug before trying to remove the cable.

# Gutwire

## Design Philosophy

GutWire Audio Cables was founded on one simple principle: Our products retrieve what is on the recording; no adding or subtracting from the signal. We firmly believe in the superior sound of cold-welding (a.k.a. crimping) in the termination process. During our research process, 10 out of 10 times, we found our listening panel voting unanimously toward cold-welding terminated cables. Cables that are terminated with cold welding offer the following benefits: well-defined soundstage, maximum dynamics, real-life midrange and amazing 3D imaging...just to name a few.

Our cables are composed of high purity oxygen-free copper. It is used after much experimentation with other materials. Copper delivers the most neutral, transparent and natural musical signal. Unique wire-weave patterns and the use of finest materials available contribute to the renowned GutWire sound. All of our cables employ a sophisticated shielding to reject Radio Frequency Interference (RFI) and Electromagnetic Interference (EMI). Effective shielding assures that the signal is not polluted. With our effective shielding, up to 98% of the RFI and EMI are filtered out without any compromise to the audio signal. Some cable manufacturers rely on capacitors, coils or resistors to alter the audio frequencies. Others modify generic cable products with their own connectors. While these approaches work in certain degree, they impose limitations. GutWire Audio does not rely on pre-manufactured designs or other additives to achieve the 'ultimate' sound. Our secret is our design itself, hand made construction and the use of the best materials in the world. This is GutWire Audio Cables.

Every product has to satisfy one very important criterion before leaving our factory: Every cable has to sound musical. Simple as it may seem, this is one of the most important and hardest things to achieve when we design our cables. Being musical means that you are able to listen and enjoy hour after hour of music in total enjoyment. With our cables plugged into your system, your concentration is only on the music. You do not need to worry about the pros and cons of the cable. Moreover, our cables are very natural sounding. They are capable of reproducing music that surrounds the listener with a SOUNDFIELD that you have never experienced before.

All GutWire cables are individually handcrafted which means -NOT machine- manufactured. They are also individually tested to ensure each cable meets our exact standards.

## Frequently Asked Questions (FAQ)

### Does GUTWIRE sell direct?

GutWire is only available through its network of authorized dealers and distributors. For the names of the nearest dealer, please click on the DEALERS LOCATION at the bottom of the page.

### What changes can I expect when using GUTWIRE in my system?

GutWire will improve the overall resolution and tonal balance of your system and provide: incredible soundstage that extends in height, width and depth.

low frequency response that is accurate, deep, powerful and authoritative.

real-life midrange that is natural and musical.

amazing 3D imaging with body and texture.

Do GutWire cables use any capacitors or inductors?

GUTWIRE cables do not use any capacitors, resistors, coils or inductors in their construction that would alter the frequencies the cable delivers and limit the flow of current.

### Are there any advantages of cold-welding (aka crimping) the terminations?

GUTWIRE cables do not employ any soldering in the termination process of the power cables or the balanced interconnects (Click [HERE](#) to see what we are using). During our research and extensive listening tests, we realized that crimping is surely better than soldering. The cables with crimped terminations demonstrate a much wider and more open soundstage along with better micro and macro dynamics and faster transient attack.

**How long does it take to break-in a GUTWIRE cable?**

A GUTWIRE cable needs about 50 hours of burn-in time to get 75% of their optimum performance, and it will continue to improve the sound for up to 100 hours.

**Why are GUTWIRE cables made of stranded wire instead of solid core wire?**

People have argued that solid core wire is used in power transformer, output transformer and the transmission line so the use of solid core wire seems to be a normal extension. Keep in mind that all those power facilities are built by the lowest-bidder contractor for the government. The only concern for these contractors is the lower cost of solid core wire. They are not concerned with the improved sound quality of stranded wire.

**I want to upgrade the cabling in my system but I don't have the money to do it all at once. Which cable should I upgrade first?**

When upgrading the cables in your system, it is advisable to start with the one that draws the most current. Upgrade the power cable at your amplifier first, then the one at pre-amp or DAC; and your transport for the last. For interconnects, it is logical to start at the source first. Upgrade with a GUTWIRE digital or line level interconnect, then your speaker cables.

**What is the purpose of the clip that comes out of the IEC/RCA connector?**

The clip is connected to the outer shielding of the cable. It gives the option of floating or grounding the outermost shielding. All of our cables feature multiple shielding in the design. In our extensive listening tests, the ability to float or ground the outer shield affects the sound dramatically. We give you, the listener, the option of fine tuning the sound to best suit your system.

**Your cables seem to be putting a lot of emphasis on shielding, why is that?**

Living in a world full of electronic pollution, we don't know how to predict RFI and EMI. Background noise, grounding problems and electrostatic noise can be largely eliminated with well shielded cables. Cables without proper shielding will no doubt hinder system performance.

**Why does the braid jacket on the cable seem so loose?**

The tightness of the braid material affects the sound. If the braid jacket is too tight, the sound will lose its "vividness". The amount of "looseness" of the braid jacket is determined after countless hours of empirical research.

**Is there a difference between a balanced (XLR) interconnect and a single-ended (RCA) interconnect?**

In a balanced circuit, there is a positive signal, an inverted signal and a separate ground. In a single-ended circuit, there is a positive and a negative signal. The negative signal acts as a ground, too.

Our balanced interconnects are completely different from our single-ended interconnects. Each balanced interconnect has three conductors and two separate shields. Our single-ended interconnect has two conductors and two separate shields. Some of the balanced interconnects on the market are not real balance design.

**Why is the Chime Speaker Cable made of four individually jackets instead of two?**

Physically separating the positive and negative signals reduces cross talk, capacitance and colorations between cables. Although it is much more expensive to manufacture, the result sound is amazingly good.

**Should I use "cheater plugs" if I have a ground-loop or polarity problem?**

We do not recommend using "cheater plugs" except for testing the absolute polarity of the component. Once the absolute polarity of the component is determined, it is advisable to change the polarity ( if necessary) inside the male IEC of the component. The use of "cheater plugs" would degrade the performance of our power cables.

Ground loop is usually caused by the difference in electrical potential between component grounds. Using more than one electric outlet and the use of cable television is also a common cause of ground loop. Installing dedicated electrical outlets to audio system can also largely eliminate the problem. DO NOT make modifications to your equipment unless you are a qualified electrician.

**I've heard a "theory" that the IEC plug of the power cord should be able to jiggle around the IEC port on the component so that the cable can resonate/oscillate with the AC current. Is that true?**

15A 110V AC electricity does not provide any room to "jiggle" around. We believe every connection should be tight and solid, whether it is a low-level signal (RCA or spade lug) or AC electricity. It is the reason why we use the best connector/plug in the world.

## **Speaker Cables**

The faint voices you sometimes hear during a phone conversation are an example of signal interference between adjacent or nearby conductors, commonly known as CROSSTALK. The term is also applied to frequencies above the audio range where more serious consequences occur when inductive or capacitive crosstalk creates distorted or erroneous data in data link systems.

The measurement of crosstalk consists of sending a signal of known strength through a conductor and measuring the effect of this signal in an adjacent or nearby conductor. Typically, the crosstalk is measured at the same end of the cable that the signal is sent from. This is known as NEAR END crosstalk (NEXT). Expressed in decibels (dB), a higher number is better. NEXT is affected by signal frequency, cable construction, and installation / connection.

The ability to maintain a high NEXT is the design foundation of our Chime speaker cable. In order to minimize crosstalk and keeping a high NEXT number, our Chime speaker cables physically separate the positive and negative signal to eliminate crosstalk between conductors.

To control the unwanted resonance, we have incorporated the use of aluminum (like the rest of the Chime series) to further dampen the resonance besides the material we are using at the end of the cables. The dimension of the cuboid is designed according to the golden-ratio. Aircraft-grade aluminum is used to absorb any vibrations from the cable. By sliding the cuboid into a different position, it will change the resonance of the cable thus yielding a different sound for fine-tuning.

Chime speaker cables give you an articulate and authoritative bass that brings out the lower-level detail of the recording. Our speaker cables are also capable of delivering very rich mid-range harmonics and extremely smooth highs. Since the crosstalk is kept at a minimum, you would be able to hear details and resolution that you had never heard before. The separation between instruments will become more pronounced; the focus will become clearer and much tighter.

### **Chime Speaker Cables (Single Wire)**



Specifications for Chime Single-Wire:

Cable Diameter: 0.75"

Conductor Diameter: .188"

Conductors: High Purity Oxygen Free Copper

Discrete Conductors: 416

Connector: WBT-0680 Cu Sandwich Spade or WBT-0645 Banana Plug

### **Synchrony Speaker Cables**



Specification for Synchrony Speaker Cable:

Cable Diameter: 0.50"

Conductor Diameter: .188"

Conductors: High Purity Oxygen Free Copper

Discrete Conductors: 208

Connector: WBT-0680 Cu Sandwich Spade or WBT-0645 Banana Plug

## THE NORDOST FLATLINE CABLE WHITE PAPER

### "LIGHT YEARS AHEAD"

#### INTRODUCTION

The original Flatline Cable was developed in 1993. Until the invention of Flatline it had been impossible to make a cable of this sound quality and versatility. Flatline Cable is patented worldwide and is a registered trademark of Nordost Corporation. The trademarks MoonGlo, Octava, 2Flat, 4Flat, SuperFlatline, Magic 1, Black Knight, Blue Angel, Blue Heaven, Red Dawn, SPM and ECO used in conjunction with Flatline Cable. Flatline Cable has revolutionised the cable industry.

The breakthrough came in a new proprietary extrusion process developed by a team of engineers working on custom cable solutions for the space program in New England. This team specialised in designing custom cable solutions for Fortune 100 companies in aerospace, military, medical, and computer industries. From this background Nordost developed its unique line of Extruded Teflon speaker cables and interconnects.

Today Nordost manufactures a range of 15 different loudspeaker cables, interconnects and digital cables as well as a proprietary CD and cable treatment and other audio accessories.

Nordost continues its research and development into state of the art cable design and manufacturing techniques.

#### MANUFACTURING TECHNIQUES

The Flatline Cable range may be divided into two types, Flat Solid Core designs and Micro Litz Solid Core constructions. Each type is made using our unique patented Extruded Teflon manufacturing process. Nordost is the only company in the world which is able to manufacture cable using this technique. Nordost has access to state of art research into new methods of cable manufacturing and design. All of the machines and extruders used by Nordost are built in-house at our factory in Massachusetts. In the following pages we will describe the unique features of our construction methods. We will use Flatline Cable as a generic term used where both types of cable have the same characteristics.

With the exception of the Octava loudspeaker cable every Flatline Cable uses Fluorinated Ethylene Propylene (FEP) insulation or jacketing. FEP is more commonly known as Teflon and is a registered trademark of E.I. Dupont. Flatline Cable is manufactured using a unique extrusion process which allows us to produce cables with very tight pitch and span tolerances which result in much more consistent electrical characteristics. The precision of conductor spacing and concentricity of the insulation around each conductor has numerous benefits such as low capacitance, low inductance and very low propagation delay. The extrusion process used results in a cable which has an insulation only 5-mils thick, compared to 70-mils thick for conventional cable design. This very precise extrusion results in cables which have a measurable performance that is far superior to other conventional cable designs on the market.

#### THE SPEED OF LIGHT

One of the characteristics which makes the Flatline family of cables sound so good is the fact that all of the cables can transmit signals at over 95% the speed of light. Propagation delay tests were run on all the cables in the Flatline range. The measurements ranged from 1.2 nanoseconds per ft up to 1.16 nanoseconds per ft for the SPM Reference Cable.

The speed tests were again run on Flatline Cable and the same result was obtained. Flatline Cable was transmitting signals at over 95% the speed of light. The tests were run a total of eleven (11) times and the result remained constant. The only cable which will transmit signals faster than this, is fibre optic cable. Measurements made on Monster Cable and a number of similar type cables yielded figures from 60 to 70% the speed of light.

The reason our cable performs like this is due to the unique geometry and insulation techniques used the construction of Flatline Cable. Because Flatline Cable reacts so quickly to signals, space and time delays and smearing are eliminated. The very high speed of the cable reduces timing errors and phase distortion as all the signals arrive at loudspeakers at the same time. So how does this increased speed affect the sound? It's the difference you can hear in the precision of a musical performance. It allows you to hear precisely the starts and stops in the music. It makes it easier to follow the rhythm and the pace of the music, and it allows the detail and subtle nuances in the recording to become a much more integral part of the musical performance. This is due to the very fast reaction time as well as other factors, such as a very low dielectric constant, which we will deal with later in this paper.

## **ULTRA LOW CAPACITANCE**

The use of extruded Teflon jacketing results in a cable which has a very low capacitance. This provides very audible sonic benefit to the cable, the reduction of phase distortions in the signal. This problem is dealt with later in this paper. The following test results show that the capacitance of Flatline Cable is twice as low as Monster Cable Hot Wires and almost four times lower than original Monster Cable.

## **CAPACITANCE AND INDUCTANCE TEST RESULTS**

### **CAPACITANCE INDUCTANCE**

ORIGINAL MONSTER CABLE	22.2pF/ft 0.16uH/ft
MONSTER CABLE HOT WIRES	12.0pF/ft 0.17uH/ft
AUDIOQUEST TYPE 4	22.3pF/ft 0.15uH/ft
AUDIOQUEST F14	12.7pF/ft 0.15uH/ft
AUDIOQUEST TYPE 6	54.2pF/ft 0.10uH/ft
KIMBER 4AG (3)	43.7pF/ft 0.10uH/ft
CARDAS HEXLINK 5(2.5)	51.8pF/ft 0.18uH/ft
SONIC LINK	15.7pF/ft 0.21uH/ft
FLATLINE CABLE	6.0pF/ft 0.09uH/ft

### **VERY LOW INDUCTANCE**

When a current is passed through a conductor, magnetic flux lines occur both inside and outside the conductor. Interaction of these flux lines opposes changes in the flow of current. This opposition to current flow can be manifested by a back voltage that develops in the circuit between the speakers and amplifier. This inductance is present in all cables, however, it is desirable from a sonic standpoint to have the inductance as low as possible.

Flatline Cable has a much lower inductance than conventional cables. In fact, the inductance of Flatline is twice as low as Monster Cable Hot Wires. Lower inductance allows the cable to react more quickly to current changes, which is essential if a speaker system is to be driven to its full potential. Parallel flat conductors have lower inductance than conventional round conductors, therefore current flows more freely. Micro Litz construction using multiple small AWG gauge conductors means that skin depth effects are minimised. In all of the Nordost Micro Litz cables such as Blue Heaven, Red Dawn and SPM, combinations of extruded silver are used over Oxygen Free Copper conductors.

This technique coupled with very precise conductor spacing results in faster signal transmission and reduced propagation delay, which reproduces every nuance of the music.

### **WHY USE TEFLON?**

When an insulating material is used between conductors carrying an electrical signal it acts as a capacitor. That is, it stores energy and later releases it.

This energy release can induce phase distortions into the signal. Keeping capacitance or energy storage to the minimum is essential to reduce phase distortions in the signal. All insulators increase their capacitance as the signal frequency increases, but some insulators are more uniform than others.

In making comparisons between speaker cable insulation materials we find that PVC is the most common and least expensive insulator, however, its insulation properties are very frequency dependent. This means that PVC will always result in the highest capacitance for a given cable construction. Polyethylene is a slightly better insulator than PVC and Polypropylene is better still.

Polypropylene also suffers from limited flexibility, limiting its use for certain applications. Teflon is by far the best insulator currently available. It is essentially uniform in its electrical characteristics at all frequencies up to 1GHz. Using Teflon lowers the capacitance thus keeping signal distortions to a minimum.

### **BURNING IN CABLE AND USE OF OFC**

Flatline Cable uses 99.9999% Oxygen Free Copper. The use of Oxygen Free Copper reduces molecular vibration in the cable conductors. This allows signals to remain purer with an audible sonic benefit. Cables such as Blue Heaven, Red Dawn and SPM use even purer copper formulations up to 99.999999% OFC.

All Nordost Flatline Cables sound excellent when first used. However, when they have been used or "Burned In" for approximately seventy (70) hours there is an improvement in performance. This is as a result of changes which occur at the atomic level in the metal of the cable conductors.

As a voltage passes through the conductor electrons take the path of least resistance through the lattice structure of the metal. This is memorised by changes in the structure and position of particles which make it easier for the signal to pass through each atom. In simple terms the electrons get lazy and take the path of least resistance.

The dielectric or insulation of the cable also stabilises and has less interaction with the electromagnetic signals passing through the conductors. The combination of these factors results in an audible improvement in the cables after some days of use.

### **THE BENEFITS OF FLAT RECTANGULAR CONDUCTORS**

Flat conductors have far more current carrying capacity than equivalent round conductors. This is due to the increased surface area of flat conductors, which maximises heat dissipation. Flatline Cable in effect runs cooler – molecular vibration of the conductor is reduced, giving it the ability to carry the same current as a physically large round conductor.

### **REDUCED SKIN EFFECT**

Skin effect is the tendency for electrical signals to travel on the outer surface of the wire. Skin effect is usually associated with amplitude attenuation (power loss) at high frequencies. At audio frequencies this effect is diminished. However, flat conductors significantly reduce audible distortions caused by skin effect.

At audio frequencies within a speaker cable, skin effect causes changes in inductance and resistance. The audio signal will penetrate to different depths within the conductor at different frequencies, due to changing electrical values. This effect is most noticeable at high frequencies, and result in an audible smearing, causing the sound to lack clarity and seem lifeless. If significant enough, listening fatigue will ensue. By using multiple, flat, separately insulated conductors, skin effect distortion is virtually eliminated.

The greater surface area of rectangular flat conductors lowers these distortions much more than an equivalent round conductor. Another problem which is eliminated with our Flatline Cable construction is strand interaction. Because Flatline Cable uses solid flat rectangular conductors individually encapsulated in insulation, current flow is not impeded, and it does not have to jump strands as it progresses down the cable. With Micro Litz construction strand interaction is also eliminated and the speed of the cable is increased. Flatline Cable performs better than any other speaker cable on the market because it runs cooler. The surface area of the cable is much greater due to the unique design of Flatline Cable. This has the effect of dissipating more heat during use.

Heat dissipation is also enhanced by FEP (Teflon) which has a much lower coefficient of friction than other commonly used insulation materials. In addition, because of the thinness of insulation material used, which is due to our unique extrusion techniques, even more heat is dissipated. This design also has applications in AC power cable transmission an area which Nordost is currently researching. This design allows Flatline Cable to deliver very high current between the amplifier and the loudspeakers and to deliver a more controlled bass with better dynamics in the music.

### **DIELECTRIC HYSTERESIS**

Flatline Cable has a very fast rise time and its "Dielectric Hysteresis" is lower than any other speaker cable on the market. Because Flatline Cable has such a low capacitance and inductance, high frequency signals propagate cleanly over long lengths. In high capacitance PVC jacketed cables, the sharp edged high frequencies will be dulled. This is due to the fact that the highest frequency components are absorbed. This can easily be shown by measuring the cable and observing the resulting waveform graph on an oscilloscope. Music should be reproduced cleanly with sharp transients and crisp detail. All of the cables in the Flatline range reproduce every transient and fine nuance of music detail. The "Dielectric Hysteresis" of Flatline Cable is lower than any other High End speaker cable on the market, due to its Teflon jacketing, low inductance and unique geometry. "Dielectric Hysteresis" alters the dielectric constant of the cable. As an electrical field is applied to the cable over time the dielectric constant will become lower, thus current will flow more freely.

The lower inductance will also allow instantaneous current changes to occur cleanly. The result is that bass frequencies are more dynamic and are not "muddy". Because Flatline Cable reacts so quickly to current changes the bass is never under-damped as occurs with many High-End speaker cables. Teflon is the material which has the lowest hysteresis of any dielectric used in speaker cable manufacture. PVC has the highest hysteresis. For more on this subject, refer to Cable Controversies by Ken Cowans, Stereophile, January 1990.



## **ZERO REFLECTION TECHNOLOGY**

As a result of research into very high speed data transmission systems Nordost has developed a cable which minimises signal reflections from a source to a component. Standing waves are also eliminated within the cable by the use of very precise geometry. In addition, the use of an extrusion of 60 microns of silver over the copper of the conductor alters the atomic structure of the interface between the silver and copper. The result is a tremendous synergy between all components in an audio system wired with Zero Reflection cable. This technique has been implemented in our new SPM Reference Cable.

## **TERMINATION TECHNIQUES**

All Nordost Flatline speaker cables are terminated with the Nordost Z Plug. This is a low mass, one-piece 4mm Banana plug made with beryllium copper which is then gold-plated. This low mass design has very low inductance and capacitance.

This type of lightweight plug preserves the low capacitance and inductance of the speaker cable at the termination point. All cables are terminated using a proprietary formula of high grade silver solder. All Nordost interconnects use high quality RCA connectors with Teflon spacers. On the premium cables, special signal before ground MoonGlo RCA connectors are used for optimum signal transfer. The MoonGlo RCA connectors use hard high conductive alloy which is gold plated. Nordost interconnects can also be order in a balanced configuration with gold plated XLR type connectors.

## **ECO 3 CD AND CABLE ENHANCER**

In our ongoing research into high technology cable design at Nordost we have found that electromagnetic fields generated by current flow in a conductor can produce stray charge build up on the outer insulation of loudspeaker, signal and power cables. These ESCs or electrostatic charges build up over time and affect the performance of cables and other sensitive components in the audio chain by interacting with the electromagnetic fields of the audio signal. They do this by increasing the effective capacitance of the cable insulation and the problem gets worse on conventional thick PVC or Polyethylene jacketed cables. This high capacitance rolls off the high frequencies and bloats the bass limiting the dynamics and detail of the music.

We have measured these fields on a large number of different cables using an Electrometer to detect potential differences. Using a very sensitive Electrostatic Field Meter we have been able to map the effects of these charges throughout an entire audio system and have found these stray charges also cause problems around source components such as Compact Disc Players and Turntables. Rotating discs and records build up large stray static fields which induce noise into the very sensitive electronics in the source components. After experimenting with a large number of different solutions we finally developed a proprietary formula called ECO 3 that works extremely well. ECO 3 is applied to the cable with a clean cloth or paper towel and the outer surface of the cable is wiped down. On compact discs the liquid is applied to the label side only and on vinyl records just on the centre label.

This is sufficient to dissipate the electrostatic field charge. The ECO 3 liquid is colourless, non flammable and is water based and will not stain plastics.

The effect on a Hi-Fi system is a dramatic improvement in detail, dynamics and musical performance as the system becomes quieter as the noise floor is reduced.

## **LOW DIELECTRIC CONSTANT**

The following tests have been done on the Flatline Cable and show its suitability for difficult installations and harsh environments. The cables which are most suitable for custom installation are 2 Flat, 4 Flat, Flatline Gold MK II and SuperFlatline MK II. Flatline Cable has a lower dielectric constant than any other speaker cable currently available due to the use of a special extruded Teflon insulation. Flatline Cable is the closest wire design to the ideal conductor which is a bare wire suspended in air. This is shown by the following measurements:

### **Dielectric Constants**

PVC	3.0 to 5.0
FEP (Teflon)	2.01
Air	1.0

Teflon being lower than PVC, results in very low phase distortion and reduced capacitance. These subjects having been dealt with earlier in this paper.

## **INSTALLATION INFORMATION**

Flatline Cables have the following American Wire Gauge equivalents when terminated normally, 2 Flat 16 AWG, 4 Flat 12 AWG, Flatline Gold MK II 12 AWG and SuperFlatline MK II is an 8 AWG cable. They are "Thinner than a credit card" and all of these cables as well as Octava, Blue Heaven and Red Dawn can be run under carpets and floor coverings without leaving any bumps. Due to the strength and durability of the Teflon exterior Flatline Cables are perfect for running under carpets in high traffic areas. They can be run outside the wall to a speaker making cable retro fitting much less time consuming and cost effective for home theater applications and other projects requiring the installation of multiple loudspeakers. The cables can be attached to the wall with double-sided tape and then covered with dry wall tape and painted. An alternative method of installing Flatline Cables is to draw a line where the wire will run, then using a circular saw with a narrow blade, cut a 1/2-inch deep line, insert the Flatline Cable sideways and cover with joint compound and paint.

## **TESTS AND TEMPERATURE RATINGS**

Flatline Cables are perfect for commercial applications as they will not burn and can withstand temperatures up to 390 degrees F. Temperature rating – 65 degrees F to 390 degrees F.

Because the insulation passes the flammability requirements for UL 910 tunnel tests, Flatline cables meet the most stringent fire and building codes, making them perfect for commercial applications such as in plenums.

The UL 910 tunnel test consists of the following:

24 feet of cable is suspended in the tunnel, it is exposed to 88 kilowatts (300,000 btu's) of methane flame from 3 pair sources spaced 41/2-feet apart on the cable for 20 minutes. The tunnel contains an airflow draft of 240 ft. per minute.

To pass, the cable must burn less than 5 feet beyond the flame spread. Flatline cables pass this test.

## **Aerospace applications**

Flatline Cables also meet the FAA FAR 25.1359 tests for use in aircraft.

The FAR 25.1359 test consists of the following:

A 10-ft. sample of the cable is placed at a 60-degree angle and is exposed to a 1812-degree F flame from a Tirrill Burner for 30 seconds.

To pass the test, drippings shall not remain flaming for more than 3 seconds after falling; the average burn length shall not exceed 30 seconds after the flame is removed. Flatline Cables pass this test.

Flatline Cables also meet MIL-C-49055B for military applications.

The special FEP jacketing will not outgas. Outgassing is caused when a material is subject to low pressure or a vacuum such as an aircraft. The molecular structure starts to disintegrate, the insulation becomes brittle and eventually breaks down. PVC outgassing is extremely toxic. In fact, for many military and aerospace applications PVC cannot be used due to this outgassing problem. The special FEP insulation is impervious to ultra violet light and will not break down when used outdoors where it is exposed to sunlight.

## **ABRASION TESTS**

The special FEP has far better abrasion resistance than many other cable insulation materials due to its molecular structure. This means when pulling the cable through tight spaces or routing it over abrasive surfaces the insulation will not break down. This abrasion resistance can be shown by using the Armstrong abrasion test ASTM D1242-56. (Data from Dupont's "Teflon Fluorocarbon Resin Mechanical Design Data" handbook). The tests show the superiority of FEP insulated cable over TFE which is a laminated Teflon cable.

TFE insulation is also a much better insulation material than PVC. The test measures the abrasion resistance of flat surfaces by pulling abrasive tape, under load, over the specimens of cable at a slip rate of 100 inches per minute.

Using a No. 320 abrasive under a 15-lb. load, weight loss was measured after 200 revolutions (1 hr. 40 min).

The following specifications indicate the superior abrasion resistance of FEP:

Weight Loss Caused by Sliding Tape

	<b>INSULATION</b>	<b>AVERAGE WEIGHT LOSS(gram per square inch)</b>
TFE FEP	0.337	0.174

FEP also has a lower coefficient of friction and contains self-lubricating characteristics.

### **FLEX AND BENDING TESTS**

The flex life of Flatline Cables are superior to similarly constructed cables using different insulation materials. This is due to the self lubricating properties of Teflon, which virtually eliminates the presence of heat when the conductor rubs against the insulation during a flexing motion. This greatly reduces conductor fracturing and extends the flex life of the cable. Due to its molecular make-up combined with the encapsulation of each copper conductor, Flatline Cable is extremely flexible and has been flex tested up to 16-million times. The special extrusion technique used on the cable enables each conductor to be totally encapsulated in FEP thus preventing delamination or cold flow problems inherent in laminated cable constructions. Cold flow problems may result in shorts between two conductors. In other words, due to the superiority of the Nordost Extruded Teflon process, Flatline Cable will not break down under repeated flexing, and is not subject to inconsistencies in jacketing during manufacturing.

### **FLUID IMMERSION TESTS**

Flatline Cables are "Nonhygroscopic" which means they are impervious to liquids and humidity absorption. The following fluid immersion tests were performed:

#### **Results**

	<b>Initial Weight</b>	<b>Final Weight</b>
Jet Fuel	105.3	105.7
Ketone	102.5	102.7
Lubricating Oil	102.1	102.4
Hydraulic Fluid	98.9	99.5
Alcohol	101.6	102.6

No insulation separation or cracking occurred. No breakdown or flashover occurred when the test voltage was applied.

### **ACCELERATED AGING TESTS**

Nordost Extruded Teflon cable will never crack delaminate or shrink. The following aging, shrinkage, thermal shock, and flexing tests were also applied.

### **HIGH TEMPERATURE AGING**

#### **Procedure**

The cable was heated to 200 degrees C for 7 hours in an air-circulating oven with tension applied to each conductor. A test voltage of 2000 volts AC was applied to test the integrity of the cable.

#### **Results**

No insulation separation, cracking, or other physical damage occurred. No breakdown or flashover occurred when the test voltage was applied.

### **SHRINKAGE**

#### **Procedure**

A 12-inch cable was heated to 200 degrees C in an air-circulating oven for 6 hours.

#### **Results**

No insulation separation, or cracking occurred. Insulation shrinkage was less than 0.125".

### **THERMAL SHOCK**

#### **Procedure**

A cable sample was exposed to the following temperatures:

High Temperature: 200 degrees C. Exposure Time: 30 minutes. Low Temperature:

Minus 55 degrees C. Exposure Time: 30 minutes. Number of cycles: 5

#### **Results**

No insulation cracking, delamination or other visible damaged occurred.

## **FLEXING ENDURANCE**

### **Procedure**

Number of Flexures per minute: 25. Number of cycles: 300. Test Temperatures: 1 at 200 degrees C and 1 at minus 55 degrees C. A test current of 20.5 Millamperes was applied throughout the test.

### **Results**

No cracking, fracturing, delamination or other damage occurred. No

As is shown by these tests, Flatline Cables can be used in the harshest environments. They can be used in the most hostile automotive locations, such as routing cables through the engine, at flex points through the doors without any breakdown occurring. They can be run outdoors in the harshest climate, and they can be buried directly in soil without conduit. Flatline Cables can be run to outdoor speakers and are perfect for boats and other marine environments, due to the fact that they are impervious to moisture and the corrosive elements of seawater.

## **CONCLUSION**

Nordost offers a range of cables that offer unparalleled performance for all audio applications.

Nordost Flatline Cables offer a level of technology and performance that is unsurpassed in the audio industry.

Throughout the range of interconnects and loudspeaker cables there is a large degree of coherence.

There is a sonic resemblance throughout the line but at each step upward in the range there is a greater degree of detail, dynamics and precision.

Visit your local dealer or distributor today and find out what audiophiles in over twenty-five countries have learned; **Nordost Flatline Cables** are **Simply Light Years Ahead** of the competition.

## HMS

Mangels anderer Quellen folgt hier ein Interview aus der Image-Hifi:

Beim Test illustrierer Lautsprecherkabel in image hifi 4/2000 hatten wir Ihnen eine eingehendere Auseinandersetzung mit dem HMS Gran Finale versprochen. Hier endlich ist sie – wenn auch etwas später als geplant. Am Rande der High End Vienna 2000 hatte Dirk Sommer Gelegenheit, mit Hans M. Strassner über Kabel im Allgemeinen und die Abstimmbarkeit seines Topmodells im Besonderen zu sprechen.

**image hifi:** Üblicherweise stehe ich Kabeln mit Kästchen und besonders solchen, bei denen sich die Größe der Einbauten proportional zum Preis verhält, äußerst skeptisch gegenüber. Das Gran Finale konnte mich klanglich jedoch völlig überzeugen. Weshalb also setzen Sie auf zusätzliche Bauteile im Signalweg oder parallel dazu?

**Hans M. Strassner:** Wenn ich zunächst den Inhalt unserer Kästchen ansprechen darf: Schon unser erstes, 1993 entwickeltes Lautsprecherkabel In Concerto war ein „Kästchenkabel“. Und dafür gab es einen guten Grund: Ein hervorragendes Kabel für den verlustfreien Transport von breitbandigen Wechselströmen zu bauen ist eine Sache. Hier konnten wir auf die Erfahrungen unserer Entwicklungsarbeiten für Supraleitungs-Messplätze zurückgreifen. Eine andere Sache ist jedoch, die marktgängigen Verstärker und Lautsprecher mit ihren teils großen Abweichungen in den Konstruktionsprinzipien und technischen Daten zu einem optimalen Zusammenspiel zu bringen. Dieser Spagat ist selbst von der theoretisch besten Kabelkonstruktion allein nicht zu schaffen. Sicherlich fühlt sich mancher High-End-Enthusiast an das mühevoll Ausprobieren verschiedenster Marken erinnert, bei dem nicht selten das ungute Gefühl zurückbleibt, doch nur einen mehr oder weniger überzeugenden Kompromiss gefunden zu haben. Auch die Idee „Alles von einem Hersteller“ ist kein sicherer Treffer, denn selbst Mercedes & Co. brauchen beispielsweise die Experten von Bosch, Recaro, Dunlop und andere.

**image hifi:** Was macht das Zusammenspiel von Verstärker, Kabel und Lautsprecher so kompliziert?

**HMS:** Das Prinzip unserer bis heute in überwiegender Mehrzahl verwendeten Lautsprecherkonstruktion ist mehr als 70 Jahre alt. In dieser Zeit hat es zwar, wie in der Verstärkertechnik, eine enorme qualitative Verbesserung gegeben. Aber der elektrodynamische Lautsprecher ist in erster Näherung ein sogenannter Stromwandler, während sich moderne Verstärker mehr und mehr der Funktion eines theoretisch idealen Spannungsverstärkers nähern. Dieser besitzt eine gegen null gehende Ausgangsimpedanz oder, wie in der HiFi-Technik definiert, einen gegen unendlich gehenden Dämpfungsfaktor. Die verlustfreie Umsetzung des komplexen Wechselspannungssignales in einen Wechselstrom zum Antrieb der Schwingspule ist die Schwachstelle auf der elektrischen Seite dieses Prinzips. Alle zwischen Schwingspule und Verstärkerausgang liegenden Komponenten nehmen zusätzlichen Einfluss auf den Umsetzungsprozess. Dies sind im Regelfall die Lautsprecherinterne Frequenzweiche, die Innenverkabelung sowie das externe Lautsprecherkabel.

**image hifi:** Sie versuchen also, den Umsetzungsprozess mit Hilfe von passiven Bauteilen im Kabel zu optimieren?

**HMS:** Ja, wir schaffen eine umschaltbare Anpassung, die aufgrund der großen Abweichungen in den technischen Daten beispielsweise im Dämpfungsverlauf von Röhren- und Halbleiterverstärkern und in der frequenzabhängigen Impedanz von Lautsprechern erforderlich ist. Und diese ist sehr gut im ansonsten fehlerfrei arbeitenden Lautsprecherkabel aufgehoben. Hier bietet sie dem Anwender die Sicherheit, nicht nur in der gegebenen Verstärker/Lautsprecherkombination, sondern auch nach einem Tausch mit einem Minimum an Abgleicharbeit ein Maximum an Klangqualität erzielen zu können.

**image hifi:** Welche Besonderheiten weist der Aufbau des Gran Finale auf – vom Einsatz passiver Komponenten einmal ganz abgesehen?

**HMS:** Gran Finale ist eine optimale Kabelkonstruktion für den verlustfreien Transport sehr schnell veränderlicher Wechselströme. Es ist nicht erforderlich, teure Edelmetalle oder nur unter Schutzgas zu haltende extreme Reinheitsgrade zu bemühen. Die entscheidenden technischen Parameter sind möglichst niedrige magnetische Streufeldverluste sowie eine frequenzunabhängige niedrige Induktivität mit hierzu passendem Ohm'schen Widerstand des Leiters. Wir wählen die Stromanstiegs-Zeitkonstante ( $\tau = L/R$ ) so, dass sie bei circa acht  $\mu\text{s}$  liegt. Erreicht wird dies durch die Verwendung von mehr als 1000 isoliert geführten Einzeladern aus OFCu definierter Reinheit und einer speziellen Verseilungstechnik zur Kompensation der magnetischen Felder. Das Gran Finale besitzt zusätzlich einen Mantel aus Ferrit, der nahezu jeden magnetischen Verlust verhindert. Die Konstruktion stimmen wir im übrigen in ihrem L/R-Verhältnis bereits mit dem Kabelaufbau auf praxisgerechte Werte ab. Wir gehen dabei von einem Verstärker-Dämpfungsfaktor 100 und einem Zwei-Wege-Lautsprecher mit circa acht Ohm aus. Für eine solche Kette sind die acht  $\mu\text{s}$  nahezu optimal. Bei kritischeren Lautsprechern mit drei oder vier Wegen und Verstärkern mit hohem Dämpfungsfaktor kommen die in den Kästchen eingebauten Korrekturalelemente zum Einsatz: mehrstufig schaltbare Serienwiderstände und Induktivitäten. Mit den Widerständen lässt sich der Stromanstieg beschleunigen, mit Induktivitäten verzögern.

**image hifi:** Was macht komplexere Lautsprechersysteme so kritisch?

**HMS:** Nehmen wir beispielsweise einen Verstärkerboliden mit hoher Dämpfung und einen Vier-Wege-Lautsprecher mit kritischen Impedanzsenken im Bassbereich, die mit einem querschnittstarken Lautsprecherkabel verbunden sind: Das Klangerlebnis wird ein unkonturierter, aufgeblähter Bass und eine harte Hochtonwiedergabe sein. Ursache für dieses unerwünschte Ergebnis ist der hohe Blindstromanteil im Bereich der Bass-Impedanzsenke. Da sowohl das Kabel, aber auch der Verstärker extrem niederohmig sind, wird aus dem Parallelschwingkreis der Bassweiche ein regelrechter Energiespeicher. Dies führt zu einer unzureichend gedämpften Schwingung zwischen Basschassis, Weiche, Kabel und Verstärker, und so zu dem unkonturierten, aufgeblähten Bass. Die Härten in der Hochtonwiedergabe stammen aus der nichtlinearen Reaktion der Endstufen-Transistoren und aus Verzerrungsprodukten des Kabels durch die hohe Strombelastung. Mit einem querschnittsschwachen, also höherohmigen Kabel oder Verstärker mit kleinem Dämpfungsfaktor wäre das Problem wahrscheinlich unauffällig geblieben. Abhilfe schaffen unsere TOP-Match-Line Lautsprecherkabel oder die TOP-Match-Boxen für Fremdkabelanschluss, denn auch hier ist der notwendige Verlustwiderstand gezielt mehrstufig einstellbar.

**image hifi:** Sie setzen also den unter größtem konstruktiven Aufwand von den Verstärkerentwicklern maximierten Dämpfungsfaktor wieder herab?

**HMS:** Genau darauf läuft es in diesem Fall hinaus. Der Begriff Dämpfungsfaktor ist ja eine von uns Technikern auf der Suche nach dem Ideal kreierte messtechnische Größe – für den Verstärker allein als Qualitätsmaßstab sicherlich zutreffend. Die technisch nicht ideale Funktion unserer Lautsprecher fordert jedoch ihre Kompromisse. Es sollte über die Aussage „Ein hoher Dämpfungsfaktor ist erforderlich, um die Bewegung der Bassmembran besser kontrollieren zu können“ erneut nachgedacht werden. Bestätigt wird dies auch durch die Erfahrung, dass Röhrenverstärker und Verstärker mit kleiner oder gar keiner Gegenkopplung durchaus sehr gute klangliche Ergebnisse erzielen können. Also keine Angst vor passiven Komponenten im Lautsprecherkabel, wenn sie denn umschaltbar sind.

## Stealth Cable

We at STEALTH believe that it's possible to build very high resolution, exceptional sounding audio cables utilizing any of the most common conductive materials: copper, silver or gold. Our experience has shown that the main sound characteristics such as extreme frequency extension, macro and micro dynamics, low-level detail resolution and perceived music signal coherency can be attributed to the particulars of a cable design - not the conductive material(s) used.

In this vein, STEALTH - recognizing the conductive materials' sonic differences - does not over emphasize superiority of specific conducting media, preferring to focus on advancements in the overall cable design - i.e. appropriate conductor thickness, shape and purity - the geometric pattern of the conductors arrangement - the material and configuration of the dielectric.

However, it is clear that the three metals each have their own "sonic signature". Further, it would seem imprudent to ignore the differences in personal sonic preference, equipment performance, room acoustics and our individual "ear" - that often make us prefer either copper, silver or gold.

Therefore, the STEALTH line of cables utilizes all three conductive materials in conjunction with superior cable design to make cables appropriate for all personal preferences and budgets. With the STEALTH "New Generation" product line being introduced in 2002, the approach taken is rather unique - we implement the most advanced cable geometry and build reference cables utilizing this uncompromising design: one with PURE SILVER, one with PURE GOLD, and one with 50-50 SILVER-GOLD ALLOY (to be released soon).

In this fashion we offer all STEALTH customers to take advantage of the superior performance achieved from the state-of-the-art design, but allow the audiophiles to fine-tune their system to their tastes by choosing the cable material with the "sonic signature" most appropriate for them - without any compromise in the main performance areas.

The "New Generation" cables demonstrate extremely impressive bench characteristics (very low capacitance AND inductance, AT THE SAME TIME - which is virtually impossible to find with any other manufacturer). The cables have unusually high characteristic impedance combined with extremely low overall "Q" factor (which prevents cables from "ringing" - i.e. emphasizing any particular frequency in the audio range and far beyond); the conductive material is proprietary: cross-wound/bifilar ultra-fine (thinner than human hair - to eliminate skin-effect related time-domain distortion) individually Teflon® insulated strands of either high purity silver, copper or gold.

Extra layers of porous Teflon®, in combination with mostly air in the center of the cable (the cables are hollow inside: thin wall Teflon® tubing is in the center of each cable) assure extremely low energy storage and therefore, the fastest possible propagation speed of an electrical signal along the cable; further, the cables feature STEALTH's newest "multilayered unidirectional" geometry (17 coaxial layers in interconnects and 43 coaxial layers in speaker cables), making them noticeably quieter than other cables and assuring unsurpassed low-level detail resolution without any loss of dynamics, "slam" and "authority".

Last, and certainly not least, STEALTH "New Generation" cables are available with optional Cryogenic treatment (proprietary extended audiophile cycle) - adding the final touch in ultimate audio performance. We cordially invite you to take a no risk STEALTH "test drive".

STEALTH AUDIO CABLES utilize the finest materials, state-of-the-art design and are individually made by hand with painstaking attention to detail. All products are bench tested and sonically evaluated to assure uncompromised quality. STEALTH offers an unconditional 30 day SATISFACTION GUARANTEE along with a LIFETIME WARRANTY against defects.

## Why Cross-Wrap?

Why Cross-Wrap? Cross-wrapping accomplishes two things:

it greatly reduces the capacitance of the cable, thus extending the bandwidth to well over 100 KHz with any equipment (even passive preamps, known for being sensitive to the cables used), and

it insures an extremely low Q inductance (Q is kept low by the inductance being evenly spread over the entire cable length; low Q is important to avoid excessive resonances).

These two features bring the "combined" impedance of a cross-wrapped cable very close to being "purely resistive". I.e. the cable mimics as closely as possible the behavior of a simple resistor-and a very good resistor at that, given the high purity of its silver conductors.

Our cross-wrapped cables also share a feature of our less expensive FLR interconnects: use of very thin wires assures minimal "time-smearing", maximal coherence of the signal passing through the cable, resulting in better "focus" and an exceptional tonal balance.

Finally, since the cables are made by hand, the wrapping is slightly inconsistent compared to machine-made cables, and this helps considerably to reduce the RF cable resonances that inevitably afflict all cables. (Artifacts of these RF resonances "pollute" the audio range even though the actual resonant frequency can be as high as 8 or 10 MHz.)

## Why Litz?

Many in the audio community hold Litz wire in low esteem. Since our CWC interconnect uses it, a balanced listing of positives and negatives is called for. As a negative, Litz wire is in effect available only in copper: silver Litz wire is prohibitively expensive, even for a "cost is no object" design philosophy. Yet silver is universally recognized as a better conductor than copper. Another negative association lies in the fact that AudioQuest "Hyperlitz" interconnects, even the expensive Diamond, are no longer highly regarded by most audiophiles.

The first of these two negatives is genuine, but still by no means a reason for giving up on Litz. The second is a pseudo-negative, as will be seen once this positive is in sight: Litz wire permits the use of individually insulated wires much finer than any that could be used separately, outside of Litz bundles.

This helps greatly to reduce "skin effect", the tendency of higher frequencies to travel on the outside of a wire and at higher speeds than lower frequencies that travel nearer the core. And listening tests comparing cables that are identical except for conductor thickness show decisively that "skin effect" is a prime threat to good sound.

This is not a surprise to theory: in particular, it seems obvious that all frequency components of a transient should strike the ear at the same time. But so far from achieving the benefits of Litz construction, AudioQuest "Hyperlitz" cables, which use at most three conductors (in Diamond) in each signal/ground "bundle", don't even achieve the benefits of using thin wire. The wires they use are far too thick for use in a decent interconnect. In at least one critical listening test, blind as to cable materials and configuration, the Litz wire positive of very thin wire easily overcame the negative of silver being a better conductor than copper. It may be relevant that the system used in this test includes electrostatic speakers.

In summary, audiophiles would be foolish not to trust their own ears when it comes to a choice between our CWC copper Litz wire cables and other, comparably priced or even more expensive cables in our line. In particular systems, the positive/negative balance will be in their favor.



## Why Not Bare Multistranded Wire?

By this term we will mean wire with a number of strands that are not individually insulated, not insulated from each other.

Typically, these bare strands are twisted together and insulated as a whole. As a signal travels along such a multistranded wire, there is nothing to keep it from jumping repeatedly from strand to another. While this feature is often mentioned as a defect, certain manufacturers have built enviable reputations on ignoring it, using only multistranded wire in their prestigious cables.

But should the defect be ignored?

We can get a better perspective on that if we first look into precisely how the signal-jumping is harmful. In our opinion, shared by other knowledgeable people, the main problem stems from the oxide film which covers every metal surface.

When it jumps from one strand to another, the signal crosses two oxide boundaries, and a thin air gap. If one strand barely touches another, the resistance of this point of contact might have some measurable value (especially with copper since copper oxide is not conductive).

But the most vital concern is that this point of contact will have semiconductor properties, the same properties that solid state diodes and transistors are built to have: it affects the signal passing through it by partially rectifying that signal.

Thus our musical signal, which starts out as symmetrical AC, becomes a little asymmetrical. This effect is subtle-but imagine how many of these "little semiconductors" there are in a run of multistranded wire! With silver, this effect is less pronounced since silver oxide is conductive. But the air gap is still there, and despite being conductive, silver oxide still has different conductive properties from those of silver the pure metal.

With individually insulated conductors, these effects can be completely eliminated. Bringing other considerations to bear as well, we arrive at this recipe for a near-ideal wire: very thin conductors, to counter skin effect, individually insulated by an excellent dielectric (to charge and discharge quickly to assure fast signal propagation along the cable): And that's very close to how our cables are made....

## About the burn-in process:

All our cables require about TWO days of initial break-in after the installation to show their "sound character" - before that time, a slight upper-midrange "brightness" or "glare" (typical for pure silver cables "out of the box") might be heard.

For approximately 7 to 10 days after the initial break-in, sound becomes progressively smoother and more natural. In general, in two weeks after the installation, cables are ready for critical listening.

Please note that in order to perform their best, my INTERCONNECT cables should be broken-in on the very same system with the very same components used for critical listening! If a cable is disconnected or used with other components, it might be necessary - for the best sound - to start the break in process from the very beginning...

According to my CURRENT point of view on the break-in process in cables, it mostly deals with the "ground potential differences" in the components used - that's why I recommend to break in the cables with the same components that will be used for critical listening. It may sound funny, but cables do break in ( a bit more slowly) with just equipment in "on" position (powered) even with no music or any signal passing through!... So, it's not strictly necessary to play something all the time. Just keep your equipment "on" and play something once in a while...

If you wish, you can even leave tubes in "stand by" position (with partial anode voltage applied - if you have this mode... Using any commercial devices or burn-in CDs is possible, but please don't count on a more speedy "break-in" compare to the above mentioned process: as it is mentioned above, cables break in mostly deals with the "ground potential differences" in the components used - not the program material played;

# Synergistic Research

## **Active shielding:**

At Synergistic Research we have just developed a revolutionary new active technology that works OUTSIDE-THE-SIGNAL-PATH to deliver a level of musical performance that will amaze you. We call this dynamic new technology Active Shielding.

Active Shielding reduces a cables natural tendency to leach electrons from the signal conductors into the dielectric by placing an active DC bias on the shield- for music that is both more powerful and able to convey subtle nuances that previously went unnoticed. In addition to active DC biasing, Active Shielding filters RF from the shield through an active three stage process- for inner detail, imaging and layering that is otherwise impossible to achieve. In short we have developed a technology that will change the way you hear music- the effects of Active Shielding are simply amazing.

## **Do Synergistic Research interconnects now have boxes on them?**

No. Active Shielding is powered through our Master Control Center that can handle up to six pairs of interconnects. Synergistic Research cables now equipped to handle Active Shielding have an interface wire that can be attached to the Master Control Center for Active Shielding.

## **So how does Active Shielding differ from network or "box" cables?**

Simple. Box cables are passive technologies that filter IN-THE-SIGNAL-PATH. This means box cables filter the music you hear. Whereas Active Shielding in conjunction with Discrete Shielding sets up a controlled barrier OUTSIDE-THE-SIGNAL-PATH to actively eliminate the effects of RFI from the music you hear while reducing the cable geometry's interaction with the music signal. In short while Passive Technologies tend to interfere with the music signal, our patent pending Active Shielding technology maintains the integrity of the music signal by reducing the interaction between the signal and the dielectric materials while eliminating RFI and EMI distortion.

## **Do I need the Master Control Center to realize the benefits of Active Shielding?**

Yes. The Master Control Center is the component at the heart of Active Shielding. In fact, the Master Control Center is a powered unit that plugs directly to AC just like any other active components in your system.

## **Do interconnects with Active Shielding connect directly to the Master Control Center?**

No, not directly. Since Active Shielding takes place OUT-SIDE-THE-SIGNAL-PATH, interconnects equipped to handle Active Shielding connect directly to your components just like before. The main difference is that interconnects wired to accept Active Shielding have interface wires that route the shield directly to the Master Control Center and then back again to the interconnect.

## **Which Synergistic Research interconnects will be equipped to handle Active Shielding?**

All Synergistic Research interconnects Phase Two and up terminated with Discrete Shielding™ can be equipped to handle Active Shielding™. Now you can opt for Phase Two through Designers' Reference interconnects ready for plug and play Active Shielding.

## **Do I need to get my Phase Two through Designers' Reference interconnects upgraded to Discrete Shielding™ before I can realize Active Shielding?**

Yes. Active Shielding works in conjunction with Discrete Shielding™ to reduce a cables interaction with the music signal while eliminating the effects of RFI and EMI from the music signal. Discrete Shielding™ is standard on all Synergistic Research cables built since Oct. 1st 1998, and was a spin-off technology from our two year Active Shielding development program. If you have cables built prior to this date, we will be happy to upgrade you to our current Discrete Shielding standard- a major sonic improvement in and of it's self. >>Discrete Shielding<<

### **Can I have my Phase Two through Designers' Reference Interconnects modified to accept Active Shielding?**

Yes. You can schedule to have your Phase Two through Designers' Reference interconnects modified here at our factory to accept Active Shielding by first bringing them up to our latest Discrete Shielding™ technology- bringing even older cables to state-of-the-art performance levels. And if you purchased your Phase Two through Designers' Reference interconnects between the dates of 9/1/98 and 12/31/98, you may be eligible for a reduced rate upgrade. Call for details at 800.578.6489.

### **With Active Shielding do I still match Synergistic Research interconnects to my system in the same way as before?**

Yes. You still match our geometry's and cable materials to your system through either our "Explorer's Guide 2nd Edition" or throughout our on-line system diagnostic here at our web site.

### **Does the Master Control Center make any provisions for system matching?**

Yes. The Master Control Center is controlled by two interchangeable modules. Our Mk I module has provisions for to contour the nature of Active Shielding™ to match the subjective nature of your components.

### **If I purchase Synergistic Research cables without Active Shielding can I upgrade to Active at a later date?**

Yes . Active Shielding™ is our ongoing commitment to be your cable for life. So as your system and technology progress think of Active Shielding as a waiting turbo option for the performance of your system. You may not need it today, but its nice to know extra performance is ready when you are.

### **Discrete shielding:**

At Synergistic Research we're proud to introduce you to a new and significant enhancement technology for Phase Two through Designers' Reference interconnects. We call this new enhancement technology, "Discrete Shielding." As of Oct.. 2nd 1998, Discrete Shielding is standard issue on all Phase Two through Designers' Reference interconnects. In fact, your current interconnects can now be brought to Discrete Shielding Specifications.

Discrete Shielding is the next step in our on-going commitment to be- "Your Cable for Life!" By committing to a lifelong upgrade policy on all Synergistic Research cables, while rolling out cost effective backward compatible enhancement technologies like Discrete Shielding, we push the envelope further- both on new AND used cables. With Synergistic Research, you are assured of state-of-the-art performance, for life.

### **Questions and Answers on Discrete Shielding**

#### **Q. What is Discrete Shielding?**

A. Discrete Shielding improves our interconnects overall performance by buffering the shield from the signal path, while eliminating RFI distortion from the music signal- for a cable that is measurably quieter.

#### **Q. What are the subjective benefits of Discrete Shielding?**

A. By increasing the signal to noise ratio in our Phase Two through Designers' Reference Interconnects, we have made them both more detailed AND smoother sounding- especially in the upper registers. This means a bigger sound stage with greater detail, and smoother frequency response for greater musicality.

#### **Q. Does Discrete Shielding have an effect on CABLE BURN-IN?**

A. Yes. New Interconnects with Discrete Shielding (ones that have never been played before) sound very similar to interconnects with hundreds of hours on them and in some ways better. Of course, interconnects with Discrete Shielding continue to improve over time, but right out of the box they sound very good- without the compression normally associated with new or "cold" interconnects.

#### **Q. Does Discrete Shielding have an effect on cable system compatibility?**

A. Yes. Interconnects with Discrete Shielding are both more detailed AND more musical. This means that they are compatible with a wider variety of components.

**Q. Does Discrete Shielding have an effect on the way I match Synergistic Research cable to my system?**

A. No. You still match our cables to your system by reading the Explorer's Guide 2nd Edition, and by taking a free System Diagnostic here on our web site. Click >>Here<< to e-mail your request for a free 40-page "Explorer's Guide" and click >>Here<< to link to our On-line Cable Diagnostic Section.

**Q. How does Discrete Shielding affect Looking Glass? I thought that Looking Glass was an unshielded interconnect.**

A. Discrete Shielding de-couples a shield from the signal path while making the shield more efficient through the use of a discrete buffer circuit between shield and ground. This means that vacuum tube electronics still "see" the Looking Glass as an unshielded cable, when in fact, Looking Glass is now shielded- making them significantly quieter and suitable for solid-state electronics. Now, Looking Glass interconnects will find a new home as a higher definition transmission line in Solid State systems while still working perfectly with vacuum tube electronics.

**Q. Why upgrade my existing Phase Two through Designers' Reference interconnects? Can my old interconnects be converted into new interconnects terminated with Discrete Shielding?**

A. Yes. By taking advantage of the Discrete Shielding upgrade to your existing Phase Two through Designers' Reference interconnects, you will be up-grading even older cables to more or less state-of-the-art performance levels. At Synergistic Research, our pledge to be "Your cable for life!" is more than just words. By making the commitment to upgrade your current cables to "state of the art," your investment is protected. When you make a Synergistic Research purchase, you know you are making a life-long investment in the performance of your stereo and multi-channel systems. With Synergistic Research, as technology and your systems evolve, so too will your cables- either through backward compatible technologies like Discrete Shielding or through our Lifetime Passport Protection Plan that allows you to upgrade your cables for life. Synergistic Research is an investment in your systems performance today, and tomorrow.

**Q. Do cables with Discrete Shielding look different from cables without?**

A. No, not really. You may see a very slight "hump" or "bump" under the heat shrink of some models but the overall look of our cables will remain the same.

**Q. What is involved in the conversion process?**

A. This is a complete rebuild and is very labor intensive. Nevertheless, we are committed to your long term satisfaction with Synergistic Research and will convert your cables to Discrete Shielding for a reasonable fee.

**Q. Is Discrete Shielding in the signal path?**

A. No. Discrete Shielding is NOT in the signal path. In fact, Discrete Shielding simplifies the signal path by buffering the shield from the music and ground signals through the use of a discrete circuit.

**Q. Is Discrete Shielding the same as a network or "box" cable?**

A. No. Network or "box" cables work by placing a network IN-THE-SIGNAL-PATH, while Discrete Shielding REMOVES the shield from the signal path.

**Q. Is Discrete Shielding available on Speaker Cables?**

A. No. At this time it does not appear to improve the performance of current transmission lines- only voltage transmission lines.

**Q. Will interconnects with Discrete Shielding be much more expensive than those without?**

A. Not really. In fact, there will be no price initial price increase until the first of the year.

**Q. Will it be expensive to have my current Phase Two through Designers' Reference interconnects upgraded to Discrete Shielding?**

A. Again, not really. For a limited time, you can have Phase Two interconnects upgraded for only \$125 per pair and Reference Series interconnects upgraded for only \$250 per pair. This price is for a limited time. As we get overloaded with conversion orders, and being that Discrete Shielding is a labor intensive rebuild, these prices will go up.

# Harmonic Technology

## INTRODUCTION

Two decades ago, inexpensive lamp cord was thought to be an acceptable connection between stereo components. Indeed, even today, many people still believe that "wire is wire" and since "electrons don't know what they are traveling through," wire can't possibly affect sound quality.

Of course, thousands of audiophiles with sensitive systems have found this isn't true, although they may not know exactly why. It is perfectly clear to most audiophiles (and videophiles alike) that cables do indeed have an influence on the sound quality (and can even affect video clarity), but how to choose the best cable for any given system has been a mystery

In the last few years, several researchers have made studies that concluded that reactive electrical phenomena affect the transfer of signal through a wire; these include the inherent resistance, capacitance, and inductance of paired wire sets. If you have studied basic electricity, you will know that inductance affects high frequencies, capacitance affects low frequencies, and resistance impedes the flow of electrical current. Since these reactive elements can vary by several hundred per-cent depending on how the wire is geometrically wound, can there be any wonder that different types of wire can sound substantially different?

## NEW WIRE TECHNOLOGY

The purpose of this article is to introduce a new type of cable design made by Harmonic Technology. This patented new type of wire is scientifically superior (and hence better performing with both audio and video signals) to every other cable on the market, regardless of price. Harmonic Technology has perfected and patented a new method of refining and casting metals which has resulted in a breakthrough design, allowing unprecedented levels of performance. Indeed, upgrading to Harmonic Technology wire will make a substantial improvement to any system, equal to upgrading an expensive component! In addition, Harmonic's cable products are modestly priced. Sophisticated audiophiles realize that most of the expense of those other "designer" cables is in the profit margin, not the materials.

Not Just Another Wire!

There is a simple explanation for the sonic differences between cables, (although the engineering behind the Harmonic design is far from simple). Four factors influence the behavior of the complex electron flow in a cable:

1. Conductor metal.
2. Insulation material.
3. Geometry of the strand configuration.
4. Connectors (plugs and spade lugs) and mechanical integrity of the connections.

### 1. Conductor Metal

Certain metals conduct electricity better than other materials, hence the ability to transmit electrons is measured by its "conductivity." Two metals have superior conductivity, copper (98% conductivity) and silver (99% conductivity). However, due to cost restraints, most manufacturers do not attempt to purify the metal beyond a certain point. High quality copper wire is normally manufactured at approximately 99.97 % purity and contains oxygen and a variety of contaminants. Since most people believe that this level of purity is sufficient, little work has been done on raising the quality level beyond this point.

Until now.

Harmonic Technology has pioneered an inexpensive method of refining metals to obtain purity levels in excess of 99.999997%, allowing a more accurate electrical signal transfer. And since the purification process is done in an atmosphere eliminated of oxygen, long term oxidization effects are greatly reduced. (Oxidation over a long time period actually degrades the performance, so eliminating this problem is important for long term satisfaction.)

## IMPURITIES

The oxygen content in commercial grade wire allows progressive oxidation over a period of time and unfortunately, copper oxide does not conduct electrons. Some of the other impurities found in commercial copper wire include iron, lead, antimony, arsenic, sulfur, and aluminum. The impurities in the wire cause distortion to the signal due to the collision of the electrons with the impurities.

Our OCC Single Crystal TM process versus typical OFHC Comparison:

	OCC	OFHC
<b>Purity</b>	>99.99997%	>99.99%
<b>Special gravity</b>	8.938	8.926
<b>Gas impurities O<sub>2</sub></b>	< 5 PPM	< 10 PPM
<b>Gas impurities H<sub>2</sub></b>	< 0.25 PPM	< 0.5 PPM
<b>Average Crystal Size</b>	125 Meter	0.02 Meter
<b>Crystal Per Meter</b>	0.008 pcs	.100 pcs

The electron flow of a musical or video nature is an incredibly complex signal consisting of both an electrical "flow" and a magnetic field surrounding the wire itself, containing thousands of packets of information per second. These packets contain hundreds to thousands of different frequencies combined with their unique phase structures. This signal is both extremely complex and also delicate, since it is quite easy to disrupt the integrity of the delicate harmonic structure traveling in "waves" on the outside surface of the conductors.

It is extremely important to deliver this complex signal with the least amount of change caused by the wire itself. Elimination of impurities which cause damage to the signal is very important if accurate sound quality is to be expected. Collision of the complex electron flow with the impurities is heard as harshness or brightness and/or veiling and dullness, since the harmonic structure of the signal has now been modified. Since these effects happen on a molecular level, it is easy to compare these collisions with the action of a diode, which also uses impurities by design to control the electron flow. Obviously, we do not wish to alter the complex musical or video signal, so wire that's just "good enough" in this case is simply not good enough! Once the signal accuracy is lost, it can not be recovered later downstream. For this reason, Harmonic Technology's unique purity processing is of great importance to audiophiles interested in obtaining correct signal accuracy and purity.

## CRYSTALLIZATION

However, another problem with more important sonic consequences arises from a byproduct of the wire drawing process. When copper slugs are forced through a small die hole to "draw" wire, the copper undergoes a molecular change due to the stress and rapid cool down of the metal. A cross section of the wire seen through an electron microscope shows that thousands of crystals have been inadvertently formed in the copper. Approximately 500 crystal boundaries per foot are found in high grade oxygen-free copper wire, with as many as 1500 boundaries occurring in normal wire. The barriers formed by the crystals become another impediment to the natural flow of electrons in the wire, adding harshness and brightness to the sound as well as changing the harmonic structure drastically, altering both image precision and sound stage focus. Indeed, the crystalline barriers add distortion to the signal, making their removal extremely important if clarity and smoothness are desired!

Please see the illustration below showing the electron micrographs of normal wire compared to Harmonic Technology's Single Crystal™ (OCC) wire. The crystalline barriers are very apparent in the normal wire, and are virtually non-existent in the Harmonic Technology wire. This is an important engineering breakthrough and is patented. Elimination of the crystalline barriers offers higher fidelity to the signal!

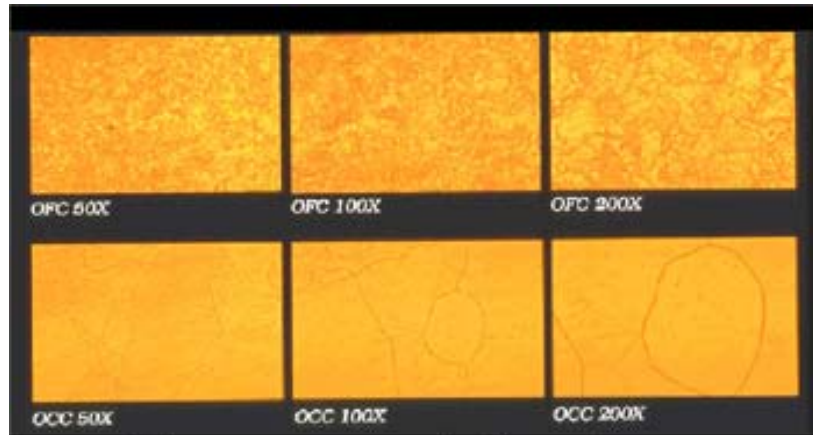

## Transversal Section

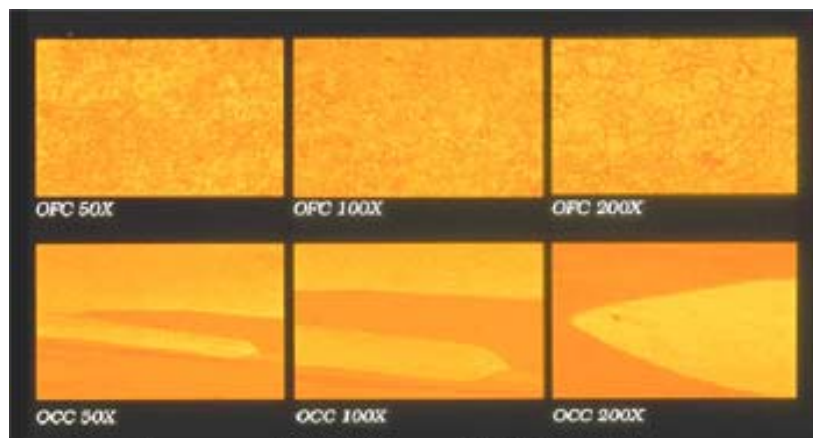

## Longitudinal Section

Comparison of Single Crystal™ (OCC) and OFHC in structure

### HARMONIC STRUCTURE OF MUSIC

A musical note is a fragile balance of minute "fractiles" of sounds, often composed of thousands of different elements. For instance, a grand piano has a felt hammer striking a compound string formed of a solid core wire with a wrapping, which then vibrates on a brass sounding board which then resonates the piano's hollow body. All of these different elements play a key role in determining that piano's "tone." If any of the harmonic overtones are destroyed by the transmission through the playback system, the sound will take on an "electronic" quality which allows you to realize that your system is not pleasing or realistic sounding. If you have heard a plastic toy piano with it's single non harmonic "dull" sound, you can imagine how important harmonics are to proper musical reproduction, since you would not want your Steinway to sound like that toy piano!

A video transmission from a laserdisc, DVD, digital satellite feed, or VHS tape has a composite signal even more complex than a musical signal. In the interest of seeing the picture intact, without any distortion of focus, color, or picture depth and "realism," it is highly important to use wires in your system which do not alter the signal transmission. For this reason, the crystal barriers impeding the natural flow of electrons must be eliminated from the wire in order to allow the signal to flow with complete accuracy. However, this is easier said than done, since many of the world's most advanced laboratories have failed to find a cost effective method to eliminate this common problem.

## PATENTED "OCC" TECHNOLOGY

Harmonic Technology has invented and patented a new method wherein a special process is used to "cast" a single crystal, eliminating the crystal barriers. Since the stress of forcing the copper slug through the cold die creates the crystal barriers upon the cool-down phase, the new Patented Single Crystal™ process is done by slow-casting the molten, purified copper through a special machine which is preheated. The cool down of the single crystal filament is done at a very slow rate, thus eliminating the unwanted stress crystallization. This casting process is code-named "OCC" technology.

The Single Crystal (TM) (OCC) Continuous Casting Process compared with Conventional Casting Process

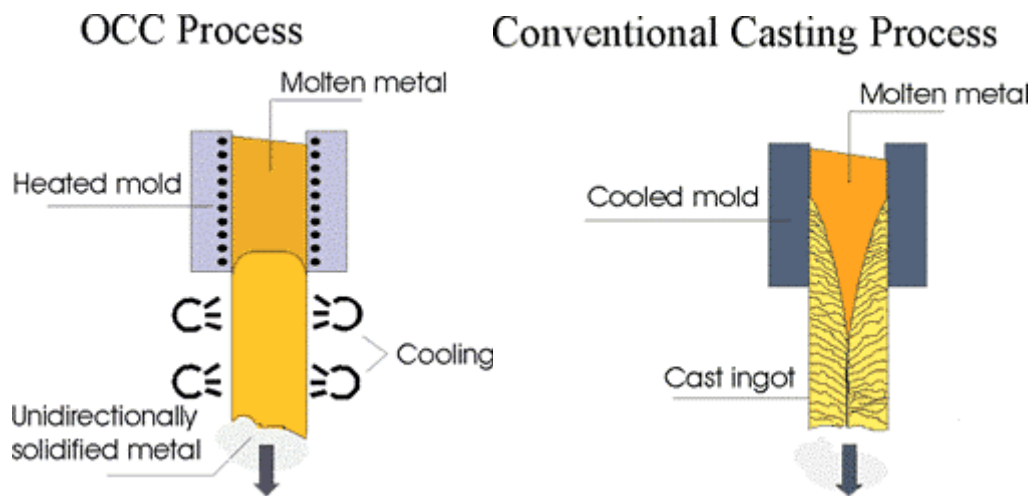

Although the Single Crystal™ (OCC) process costs much more to implement, in both machinery and time, our large scale factory can manufacture millions of feet per year bringing the price per foot down to an affordable level. Here is a state-of-the-art technology you can actually afford! The sonic result of this new technology is pure, natural sound, devoid of the harshness and two dimensional images endemic to other types of wire. Harmonic structure of the music is retained, allowing beautiful timbral differences between musical instruments to be easily heard along with three dimensional images of the instruments to be replicated in space.

Picture quality is amazingly restored to cinematic quality, looking more like a 70mm film instead of a home video, complete with natural color hues and striking image depth.

## 2. Insulation

The covering of the wire has an effect on the sound quality and video signal, since all insulation materials except a vacuum will absorb and release electrical energy. Although a wool carpet cannot transmit electrons, you can certainly realize the effect of static electricity when you walk across the rug and touch a metal door knob. In a similar manner, the absorption of energy by the insulator is released back into the wire, creating a smearing effect on the clarity of minute details. Dielectric absorption and dissipation can be measured in different materials, and the best materials that prevent these distortions are Teflon and air foamed polypropylene. Note that vinyl, the least expensive and most commonly used insulator, is quite poor since it allows distortion of the high frequencies which travel along the surface of the wire at the junction of the insulation. Harmonic Technology uses only the finest and most costly insulation materials including Teflon and air filled polypropylene, since these insulators allow the signal to travel down the wire without modification of the signal. Competing cables with standard insulation materials, on the other hand, have a smeared sound and blurry picture due to dielectric absorption and dissipation problems.



### **3. Winding Geometry**

Since a large, solid core wire cannot have equal transmission of both low and high frequency waves due to the "skin effect" (the tendency of high frequencies to travel on the surface of the conductor due to resistance), a bundle of small wires are normally used in both interconnect and speaker wire. However, there is a considerable engineering trade-off caused by the interaction of the strands. Since the electron flow can jump from strand to strand, causing arcing effects, and since there is also physical movement of the strands due to magnetization effects, bundling can also affect the signal adversely. Many companies insulate each strand of wire in the bundle, (the "Litz" design), eliminating the strand-to-strand arcing and reducing the overall skin effect level. However, the proximity effect of closely spaced paralleled conductors can increase both inductance and capacitance, which will dramatically alter the frequency and phase response of the signal.

The many differences heard between different brands of interconnects and speaker wires are mainly caused by these reactances due to their differing amounts of capacitance vs. inductance. These electrical reactances are caused by the interaction of the electrical fields surrounding the transmission path, since the signal is an alternating electrical current. In crossover design, capacitors are used to block bass signals while inductors are used to block treble frequencies. No one wants his expensive cables to alter the bass and treble in the signal or alter the picture quality!

#### **WINDING GEOMETRY**

To conduct both the positive and negative phases of the alternating signal, the pair of conductors may be geometrically situated in several fashions. First, the individual conductors may be run as side by side pairs, which allows the positive and negative fields to interact with each other, creating high inductance. Next, the pairs may be separated by distance and situated at cross angles to each other, in a woven pattern. This eliminates inductance, but unfortunately increases capacitance. Finally, the wire bundles may be set in a circle, with insulation being at the core to hold the wires in symmetry. This is better, since the geometry may be engineered to reduce both capacitance and inductance, but not totally eliminate them unless other methods are used in conjunction.

#### **SKIN EFFECT**

The so-called skin effect results from the very short high frequency waves traveling on the surface of the wire where there is less resistance to their flow. Conversely, the long wave lengths comprising the low frequencies travel through the core of the wire itself. These differences in the conduction lead to electrical field differences in the signals, causing further problems due to phase shift at very high frequencies. An additional problem of phase shift is that the bass and treble frequencies may travel down the wire at slightly different speeds since there are multiple paths that the signal can take. This further adds to a lack of coherence between the fundamental tones and their harmonics. An attempt has been made to use ancillary circuits contained in "black boxes" to reduce this distortion.

#### **BLACK BOX "BAND-AIDS"**

Several competing wire manufacturers have designed RC (resistor/capacitor) networks which claim to eliminate the phase shift caused by transmission speed differentials and capacitance/inductance effects. In strict engineering terms, these are "band-aid" devices since these RC networks correct for a problem caused by inattention to the winding geometry and insulation problems. Worse, however, is the elimination of low level detail from the signal by the dissipation of the signal at the RC network boxes. Moreover, since the speaker's crossover network is now dependent on interaction ahead of it by the RC circuit in the "black box," impedance interactions can cause further sonic problems. Many speakers do not sound their best with these "auxiliary" crossover networks interfering with their operation.

For these reasons, Harmonic Technology has chosen the "high road" and engineered the cables properly from the ground up rather than resorting to auxiliary networks. Our new technology is called "Balanced Field Geometry"™. This reduces the cost and allows for greater transparency, allowing each speaker system to operate at it's best potential. Indeed, many top speaker companies who have discovered the Harmonic Technology difference are now using our cables in their reference systems.

## BALANCED FIELD GEOMETRY™

Harmonic Technology, after several years of applied research, has engineered a technique which reduces both inductance and capacitance to theoretical levels, allowing an almost perfect transmission line path without alteration of the signal. The proprietary technology consists of "spiraling" the separated bundles of positive and negative phase wires using a hollow tubular core as a former. The insulated bundles are both twisted and then spiraled in alternating fashion, which reduces both capacitance and inductance, while simultaneously allowing both short and long wavelengths to travel down the wire at equal speeds. This reduces the phase shift to unmeasurable levels in the audio range.

This Balanced Field Geometry™ allows perfectly neutral frequency response along with very fast transient response, reproducing the signal as close to perfection as possible. This method also rejects radio frequency interference, further allowing a quieter signal with a "black" and silent background. If you have ever wondered what your components and speakers "really" sound like, without distortion, you now have a way to find out!

### 4. Connectors

The interface between the wire and the component is an important one, and a poor connection can result in mediocre sound. For this reason, we have developed an entire line of connectors, including RCA, XLR (balanced), BNC, Locking Banana's (pictured below) and spade lugs. All of these connectors have been developed using the single crystal high purity copper to provide the best transmission of detail in the signal. In addition, the tolerance of the plugs has been machined by computer controlled high precision lathes to extremely high standards.



The RCA plugs feature a locking outer barrel which can be twisted to increase tension. This can be used as a "tuning" device to alter the size of the specific images within the sound stage. In addition, the tip of the plug has been designed to fit very tightly for similar reasons. All joints are mechanically compressed before solder is applied to ensure a strong bond which will endure a lot of movement without breaking. In addition, it has been found that the electron flow in a mechanically "cold-welded" compression fitting is better than a connection using solder alone, since solder does not conduct electricity as well as pure metals which have been compressed.

We recommend cleaning all contacts before installing your new Harmonic Technology interconnects and speaker cables. This can be done with various cleaning fluids on the market such as DeoxIT and it is recommended that a suitable contact enhancer such as Torumat's TC-2, Caig's ProGold or Nekken's Carbon-Diatonic be used in conjunction. A cleaning every six months will allow your system to sound it's best.

## **Tips from Harmonic Technology**

### **#1: BURN-IN (BREAK-IN) PERIOD**

Like every audio cable, our cable requires a burn-in period. However, unlike many cables which are "bright," Harmonic Technology cables require only a 24~36 hour period of playing to sound great. Our cables may require 100 hours for a full burn-in (break-in) but most of it is done in the first 30 hours. Just like a good wine, results improve over time. Many of our customers say our wire is the best sounding wire they've had in their systems, even right out of the box!

### **#2: LOCKING RCA PLUGS**

Since our locking RCA plugs allow contact tension to be adjusted, audible changes in sound quality and image focus can be obtained by either tightening or loosening the outer barrel of the RCA plug. This effect may be system dependent, so please experiment to obtain the best results. To begin, please loosen the outer barrel of the plug by rotating counterclockwise several turns. (This removes the tension on the ground sleeve of the RCA plug). Then insert the plug into your component. Next, twist the outer barrel clockwise until you feel the tension becoming tight. At this point, the small adjustments in tension will become obvious when your system is transparent enough to allow the change to be heard.

Our XLR plugs do not allow this tightening feature. However, the balanced operation of the signal and ground conductors results in the best shielding, permitting long interconnect runs greatly minimized noise and distortion.

### **#3: WARM-UP TIME**

Just like an automobile engine, our cables need both a break-in and a warm-up time since they are incredibly sensitive and transparent. (Note: If your previous cable was so colored that you didn't hear any difference after break-in, rest assured that they are not totally transparent or that your system has a component which is veiling the overall sound.) Each time you play your system, you will note a remarkable increase in smoothness and body within a few minutes, especially if you have reinserted the cables into your system or have physically moved them.

Q. What happens if I wish to evaluate the Harmonic wires before they are fully broken in? A. You may hear a sound slighter leaner than you are accustomed to, since full weight and body of the sound is not as apparent until the molecules of the metal have settled into place. In addition, the free radical electrons in both the signal path and the surface of the dielectric need to be "pushed" out of the way by the signal flow until the path is cleared. Since these processes take time, you will not hear the full potential of the Single Crystal wire during the beginning of the break-in process. Yes, we realize that these concepts are controversial, but even the most brilliant Nobel prize winners don't exactly know how electrons are transmitted down a wire!

### **#4: ORIENTATION**

For best performance, orient the interconnects at a 90 degree angle to the a.c. power cords.

### **#5: CONTACT ENHANCERS**

We also recommend thoroughly cleaning all contact surfaces of all connections (audio and video interconnects, loudspeaker cables and power cords alike) once every few months with a contact cleaner such as DeoxIT in order to eliminate any surface oxidation. We also recommend the use of a contact enhancer such as Torumat's TC-2, Caig's ProGold or Nekken's Carbon-Diatonic on all contact surfaces before installation of the cables. A better electrical contact will result, with smoother high frequencies and more sound stage "air" and image float being apparent.

## Nelson Pass

### SPEAKER CABLES: Science or Snake Oil

From: Speaker Builder, 2/1980 Nelson Pass

AUDIOPHILES RECENTLY BEGAN reexamining the performance of every link in the audio playback chain, and before long their attention turned to the lowly loudspeaker cable. In response to demand, a number of companies are producing or distributing new and exotic cables claimed to improve audio power transmission from amplifier to speaker.

Pointing to lower resistance and inductance, proponents of the newer cables insist they sound significantly better ("better than an expander!"); however, the subject is controversial, and some hi-fi notables claim performance increase is negligible and the higher capacitance of some new cables can cause amplifier instability and damage.

Neither view is completely correct: the new cables are neither panacea nor placebo, but components whose characteristics must be evaluated in the context of their usage.

Hoping to shed some light on the subject, I obtained samples of various cables, performed a number of tests, and drew a few conclusions.

Almost everyone seems to agree that ideally the amplifier should be so intimately coupled with the loudspeaker that the cable can cause no power loss or distortion. This corresponds to a wire having no resistance, inductance, or capacitance, which in real life translates to an infinitely short cable.

I treat this premise as fundamental, because in general it results in the best performance. (It may not do so in some specific situations; for example, one could imagine a special case where some resistance or inductance might improve the sound.)

Regardless of the cable type, the effects it introduces to a signal are proportional to its length: the shorter the cable, the more intimate the connection between amplifier and loudspeaker.

Subtle differences between cable types become more dramatic with increasing length and shrink toward zero as the cable gets shorter; thus the audiophile whose amplifiers sit close to his speakers need be less concerned than he whose cables are 40 feet long. To this end, some manufacturers have installed amplifiers within their loudspeakers, exchanging speaker cable problems for preamp ones; commercial sound distribution systems have resorted to higher voltages, which improve transmission much like the high voltage utility lines which carry power many miles.

Fig. 1

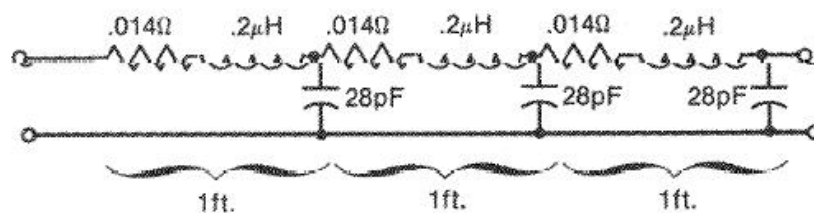

Fig. 1 Simple model 18G loudspeaker cable.

Fig. 1 shows a fairly simple first order model of a loudspeaker cable.

The inductance, resistance and capacitance are approximated as components in a circuit, sectioned off per unit of length. In this example, the values are for simple 18 gauge "zip" cord and one foot lengths, so that L is the inductance per unit foot, R is the resistance, and C is the capacitance, measured in Henries, Ohms, and Farads respectively. As a practical matter, the values of these elements represent tradeoffs against each other: for example, low inductance is easily achieved with high capacitance and vice versa, and the ratios of these values give rise to the cable's characteristic impedance, as I shall discuss later.

Researchers have chiefly concentrated on the cable's inductance and resistance, for they impede the flow of electrons between the amplifier and the loudspeaker. Resistance causes loss at all frequencies while inductance causes loss proportional to the frequency. Capacitance has not usually been considered significant because its values do not impinge upon the audio band. However, we will see later that it may sometimes be important.

The new kinds of cable seek to reduce resistance and/or inductance and thus improve the amplifier-speaker connection.

They fall into two categories: multistrand twin lead of various gauges (lamp or "zip" cord being an example) and low inductance - high capacitance coaxial or interwoven types.

Their measured performance also falls into two categories, 0-100kHz effects and 100kHz - 40MHz effects, which for convenience I will treat separately.

My analysis was greatly simplified by the fact that within the two cable categories performances were very similar; indeed, many of the cables were virtually identical at higher frequencies.

I tested five different types of twin lead cables: 18 and 24 gauge "zip" cord and three specialty cables, "Monster" Lucas cable, and Fulton wire (gold). I bought two samples of each of 18 and 24 gauge wire off reels at a local Radio Shack and a hardware store. All the cables tested were 10 feet in length.

"Monster" cable, marketed by Audio Sales Associates in San Francisco, California, is an approximately 11 1/2 gauge twin lead, similar in construction to very large lamp cord with a thick clear plastic jacket, with large spade lugs at each end for attachment to large screw terminals on "five-way" binding posts as commonly supplied on loudspeakers and amplifiers.

Lucas cable is approximately 14 gauge, jacketed in green plastic with a ribbon shape, and is marketed by S.O.T.A., Halifax, Canada.

Fulton "gold" cable, available from Fulton Musical Industries with dual banana and other connectors, is an extremely large gauge twin lead having by far the lowest resistance of any cable tested; it is also useful for pulling up tree stumps or jump starting locomotives. Fulton also make a "brown" version similar to Monster cable.

The four samples of low inductance cable I tested boasted more exotic construction than zip cord. Two colorful types, Polk Sound Wire and Audio Source Ultra High Definition Wire, use large numbers of separately insulated strands closely interwoven in such a way that the wires cross at an angle to each other instead of running parallel. This reduces the magnetic induction between strands and lowers cable inductance, at the cost of higher capacitance.

High definition cables, another variety of low inductance cable from Audio Source, consists of eight twisted pairs of wire arranged into a flat ribbon. Mogami wire is a large coaxial cable consisting of a grey plastic housing containing two concentric "shells" of wire strands, the inner conductor enclosing a plastic core.

"Smog Lifters," another tested cable, is distributed by Disc Washer. It bears a resemblance to Audio Source's high definition cable, with loosely woven braids of conductor.

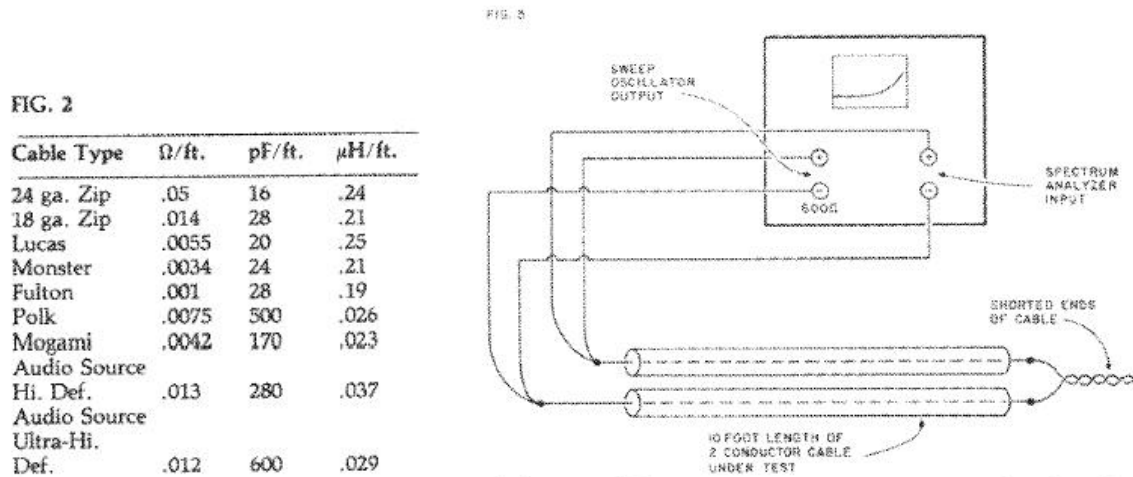

Fig. 2 shows the relative values of resistance, capacitance and inductance of each of these cables.

### SERIES IMPEDANCE TEST

I tested a 10 foot sample of each cable type using the Fig. 3 setup.

I drove the cable by a high source impedance and measured the voltage across it, showing its series impedance. This voltage, referenced to a 0.1 ohm non-inductive resistor and measured from DC to 100kHz, clearly shows the cable impedance's resistive and inductive components (Fig. 4).

Fig. 4 Series Impedance

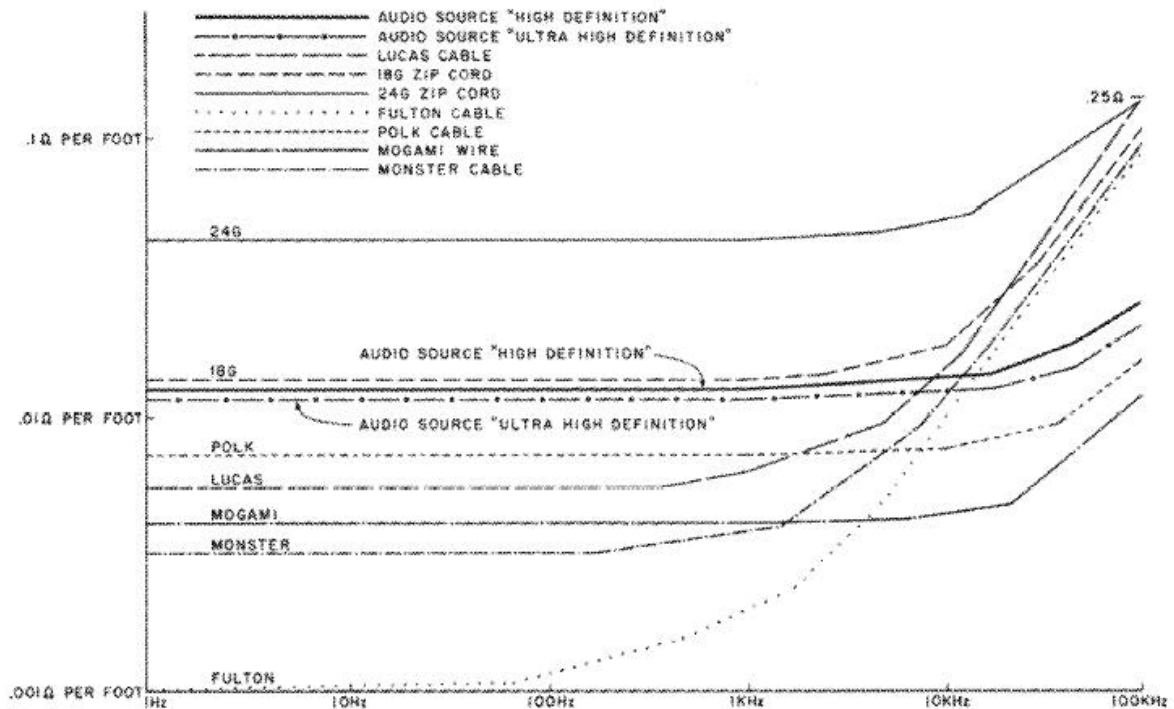

For the twin lead types, inductive and "skin effect" (an additional high frequency resistance effect) components begin to show up at about 1kHz; they increase the impedance, causing high frequency loss in addition to the cable's resistive losses. Interestingly, all the twin lead types have similar cable inductance values, approximately 2uH per 10 feet, and in the region just above the audio spectrum they are nearly identical. Below 20kHz they fan out to their respective resistance values. The lightest wire, #24, clearly has the most loss, while Fulton cable has the least.

The series impedance test differentiates the low inductance cables from twin lead as they exhibit an order of magnitude less impedance at 100kHz. Of these, Mogami Wire had the lowest series impedance, by virtue of its lower resistance; but each of these types has to all intents and purposes inductance effects. The series impedance is a more or less linear function of the length of the cable, so a one foot length will have one-tenth the series impedance shown while 100 feet would have 10 times the amount.

#### IMPLICATIONS OF LOW FREQUENCY TEST

The existing literature covers the subject quite well. However, I think you will find it useful if I briefly touch on the effects of this series impedance as it relates to frequency response and damping factor 4, 5, and 6.

The performance context lies also in the amplifier's source impedance and the loudspeaker's load impedance.

The system's performance will depend on the complex sum of the impedances involved:

$$Z_{\text{source}} + Z_{\text{connections}} + Z_{\text{cable}} + Z_{\text{load}}$$

The speaker has generally been designed to be driven by a voltage source, so our ideal premise requires source and cable impedance to be very small compared to speaker impedance. In this case, the speaker's design dominates the performance as intended so the variations in the loudspeaker's impedance do not interact to produce frequency response deviations.

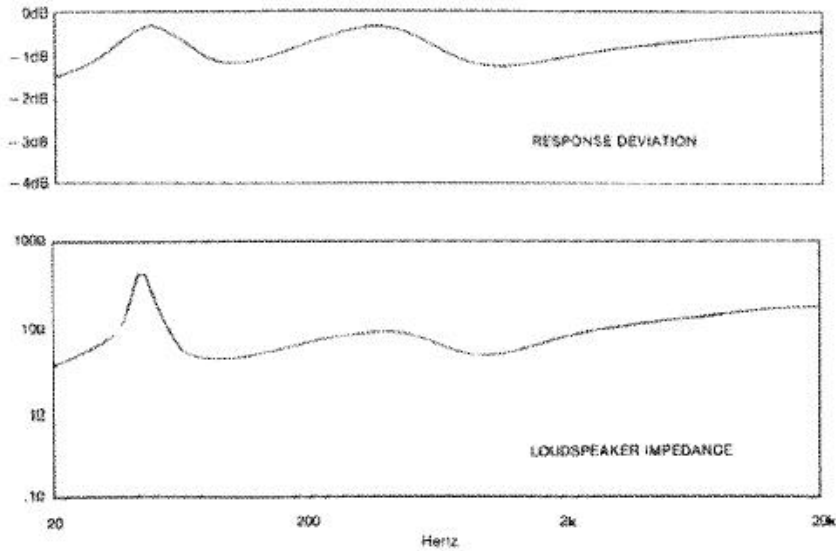

Fig. 5. Effects of 40ft 18 gauge cable on frequency response.

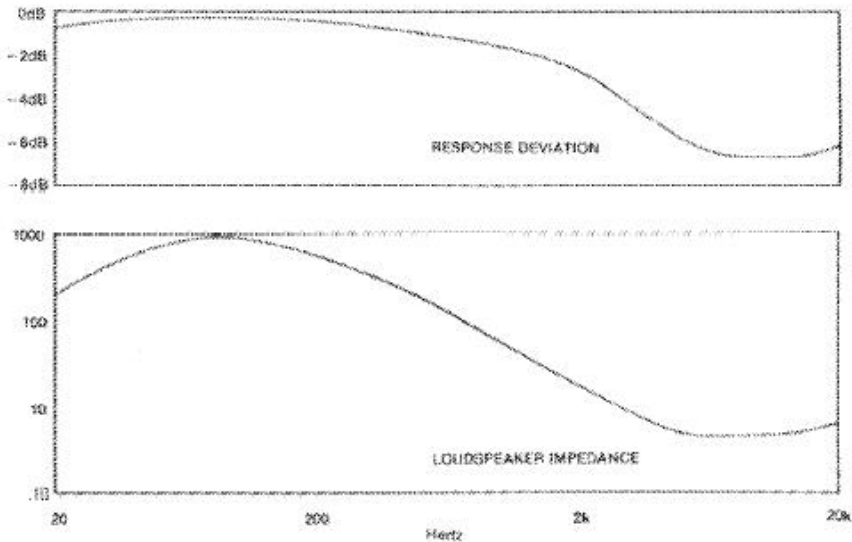

Fig. 6. Effects of 40ft 18 gauge cable on frequency response.

Fig. 5 gives an example of such a case, where the aberration is relatively minor; however, Fig. 6 shows the effects with one particular loudspeaker (which really exists) where the deviation is dramatic. Just as the cables have an inductive element, so do the amplifiers which drive them. In tube amplifiers the output transformers provide the inductance whereas in most solid state designs the designer has deliberately provided inductance in the form of a coil for added circuit frequency stability. The reason that damping factor ( $8\text{ohm}/\text{output } Z$ ) has been traditionally quoted at low frequencies is not only because much of our interest in damping centers on the woofer, but also because this coil destroys the damping factor at high frequencies.

In fact, examples exist of solid state amplifiers which quote damping factors of 500 or greater at 20Hz but which have damping factors on the order of 15 at 20kHz. More recently a few designs (Threshold, Audio Research, Yamaha) have dispensed with output coils, giving them more constant damping factors across the audio band. The new IHF test standards call for measurement of damping factor at all audio frequencies.

Again, this parameter must be evaluated in the context of the system. For example, most loudspeakers have a considerable inductive component of their own, which may easily provide the desired case of  $\text{amp } Z + \text{Cable } Z < \text{speaker } Z$ .

Conversely, the source and cable inductances become more important with loudspeakers whose load impedance is resistive or capacitive, especially with some electrostatic designs. Our initial premise does not always hold either, for I have seen "poor quality" cables used to isolate an amplifier from a reactive loudspeaker and thus improve the performance.

In general, however, we are looking for amplifiers with low output impedance and cables having low series impedance.

### VERY HIGH FREQUENCY TESTS

Ordinarily a discussion of loudspeaker cables would stop here, at 100kHz, where we could safely say that the performance is becoming negligible, if for no other reason than that we cannot hear this frequency (a concept disputed by some audiophiles). However, the advent of wide bandwidth power amplifiers has demonstrated other new effects; several amplifier designs (stable with reactive loads such as capacitors) oscillate into low inductance cables with a variety of results. Threshold Stax, and Electro- Research designs behave violently, while others acquire oscillation-caused colorations, usually either a hard, etched, high end or warmth and thickness in the vocal range (due to low order intermodulation sidebands and harmonics).

Fig. 7. High Frequency Test

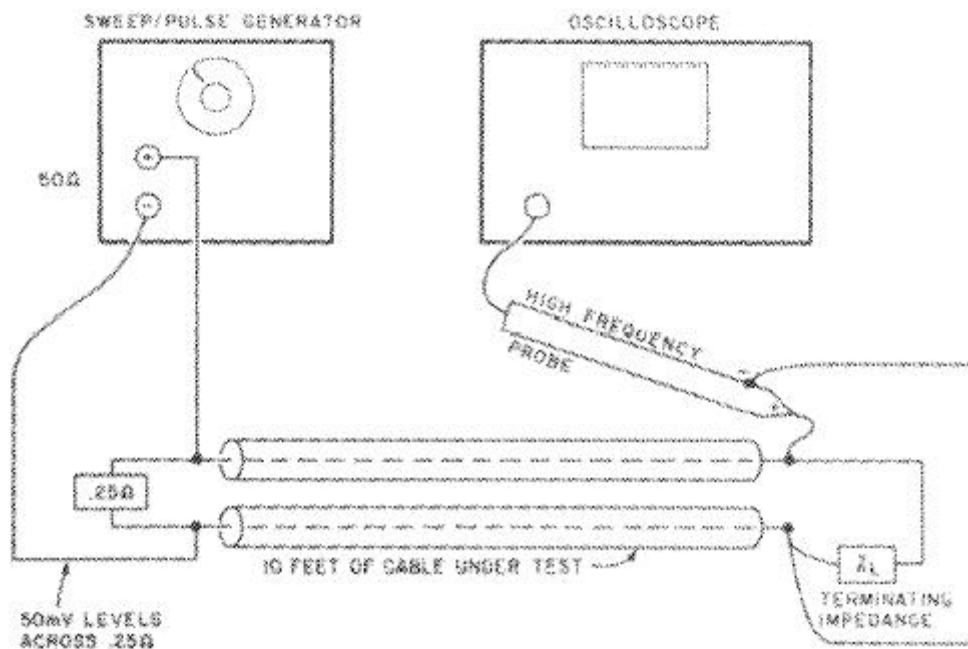

Clearly things are happening above 100kHz; to display them I performed two tests on the cable samples. In the first I swept the frequency output of a 1/4ohm resistive source from 100kHz to 40MHz while measuring the voltage at the other end of the cable with various load impedances.

In the second test, I used the same source to send a 5μS pulse down the cable for viewing at the other end. (see Fig. 7).

Fig. 8 displays a condensation of over 50 photos showing the test system's response to each variety of cable and load. The unterminated "no load" series shows the equivalent performance of loudspeakers with a substantial series inductive component, while effects of resistive (8ohm) and capacitive (.047uF) loading appear in the following two vertical columns. In the frequency response, we see large peaks occurring in the 1-10MHz region. Remembering that we sent 50mV down the cable from the oscillator, it is surprising to discover amplitudes as high as 5V on the other end, an apparent gain of 1001. As shown by the ringing in the pulse waveforms, this highly resonant condition occurs with every variety of cable, but at different frequencies and "Q" factors depending on the source impedance, the load impedance, and the type and length of cable.

The explanation for this resonance is reasonably simple if we consider that it takes a certain amount of time for the signal to travel down the cable.

A wave's velocity proportional to its "characteristic impedance,"  $Z_0$  a value expressed in ohms and determined by the inductance and capacitance:

When a wave travelling down a length of cable reaches the end of the cable, it will do one of three things depending on the impedance of the load. If there is a high impedance load, so that  $Z_L > Z_c$ , the load will reflect energy positively back down the cable to reappear at the source (Fig. 9).



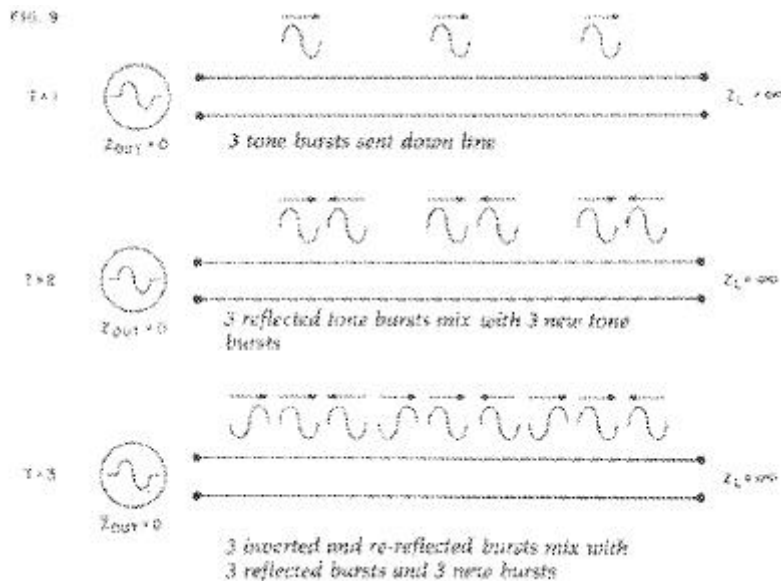

If the load impedance is less than the characteristic impedance of the cable, the wave is reflected back negatively; and if  $Z_L = Z_0$ , then the wave is fully absorbed and none is reflected.

This mismatch of load impedance to cable impedance causes the resonance observed in Fig. 8, which we see diminish in Polk and Mogami cables when they are loaded with 8 ohms, a value near their characteristic impedance. By contrast, twin lead conductors have a higher characteristic impedance and perform better at multimegahertz frequencies with about 8 ohms load impedance. The effect of twin lead cable on a 5uS pulse with an 8 ohm load shows the effect of a load impedance lower than  $Z_0$ , where the cable inductance cable rolls off the edges of the pulse, but where the 8 ohm resistance is sufficient to damp the ringing which occurs with  $Z = 0$  or  $Z_L = \text{infinity}$ .

Not so for capacitive loads as shown in the fourth column where another resonance altogether has developed due to the inductance of the cable and the capacitance of the load where: Note that these effects exist with all cables.

The fact that only the newer, low inductance cables appear to affect amplifier stability brings us to a point which justifies our examination of a cable's performance in regions which are simply not audible. The lower resonant frequencies of the cables having low  $Z_0$  enter into the output bandwidth of the amplifier as it approaches its unity loop gain, and by altering its phase response cause oscillation at the resonant frequency.

Earlier amplifiers as well as some currently available, having slower output stages (less than 1MHz), did not interact with these resonances because they occurred above the cutoff frequency of the active devices by an order of magnitude. However, as the newer cables decreased impedances and as amplifier output stages increased in bandwidth beyond 5MHz, the two effects met and resulted in various forms of sonic problems, fuse blowing, and worse. At Threshold we first ran across the problem with the mating of our 400A and Polk sound cables which caused fuse blowing (due to oscillatory cross-current conduction) with great regularity.

After a period of confusion, Matt Polk and I realized independently that the lack of a characteristic termination was causing the problem. Polk developed and patented a "damper" consisting of a .047uF capacitor and 6 ohm resistor in series placed across the loudspeaker, while I used the same network but with .1uF and 5 ohms. The results of this network are seen in Fig. 8 where the resonance in the pulsed waveform is damped out, restoring stability to an otherwise oscillating amplifier.

Since Polk's commercial introduction of the damper circuit we have found it cures oscillation problems caused by the other exotic low inductance cables. It is necessary whenever a reasonably long length (>3 feet) of low inductance cable is mated with any wide bandwidth amplifier. It interacts unfavorably with twin lead conductors (Fig. 8) which require higher impedance values (say, .01uF, 60(2)); however, twin lead's higher characteristic impedance and resonant frequencies are in any case unlikely to induce oscillation in amplifiers now available.

With this much information, we might think we have the subject nailed down. However, we could easily install the finest amplifiers, cables, and terminating impedances and achieve 100 times the distortion of the amplifier alone. Loose, dirty, or oxidized connections can, while measuring well with an ohmmeter, cause high amounts of harmonic and intermodulation distortion. When high distortion occurs during an amplifier checkout at Threshold one of the first things we do is replace or tighten the cable from the amplifier to the load; we have thus cured many "defective" amplifiers.

Copper and aluminum oxidize quickly and oils from our fingers find their way to the conductor surfaces, causing poor contact; so on more than one occasion the dramatic improvement provided by an exotic cable has merely demonstrated the extremely poor quality of the previous cable's long neglected connections. Wire connections can age, and anyone wishing to accurately evaluate the newer cable's improved quality should first renew the contacts on his current set. Banana plugs and five-way binding posts make excellent connectors as long as they are kept clean; however, while the connector's plated surface resists corrosion, the wire to the connector interface can become bad and should be periodically checked, especially if it is subject to motion.

### OPINIONS

At this point many audiophiles are wondering, "Where are the listening tests?" I have listened to these cables on a variety of amplifiers (mostly my own) and loudspeakers, including Magneplanar Tympani 1 D's, MG II A's, modified Dayton Wright XG 8 MK III's (as shown in Fig. 6) Cabasses; I have also heard some examples on Dahlquist and Snell loudspeakers.

Frankly, I found it difficult to assess the results except at the extremes of performance.

For 10 foot lengths with properly terminated cables and speakers with inductive high frequency characteristics, the differences between low inductance cable and twin conductor are extremely subtle and subject to question. With a low output inductance amplifier and a Heil tweeter (whose impedance is a nearly perfect 6ohm resistive) the difference was discernible as a slightly but not unpleasant softening of the highest frequencies. Fulton or Monster cables were a clear improvement over 24 or even 18 gauge, though a little less subtle than I would have expected, leading me to believe that the effort associated with heavier cables pays off in bass response and in apparent midrange definition, especially at crossover frequencies. The worst case load, the modified Dayton Wright electrostatics, presented some interesting paradoxes: the extremely low impedance involved showed the greatest differences between all the types of cables. However, the best sound cables were not necessarily electrically the best because several amplifiers preferred the highest resistance cable. In one case, I had to use 24 gauge cable to prevent tripping the amplifier's protection circuitry.

### CONCLUSIONS

Who am I to dispute the feelings of audiophiles who, evaluating any cable in the context of program source, amplifier, speaker, and listening room, decide they can hear the difference? A few guidelines have emerged here, but the final judgment belongs to the user. All the special cables mentioned worked well on the test bench and, given the assumption that series impedance should be minimized, all of them work better than 16 gauge wire. If, like many audiophiles, you have spent a small (or large) fortune on your hi-fi system, money spent for high quality cables and connectors is a reasonable investment.

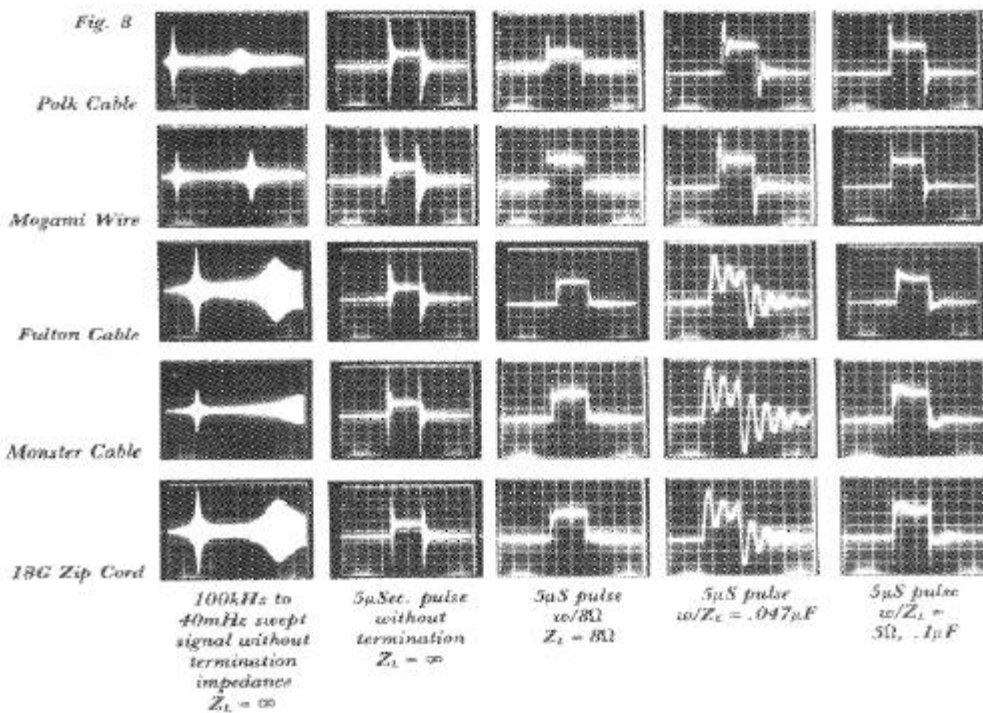

## REFERENCES

1. Brochures/Pamphlets:
  - a. Fulton Speaker Cable. Fulton Musical Industries, 4428 Zane Ave. North, Minneapolis, MN 55422.
  - b. Mogami Speaker Cable.
  - c. Polk Audio Sound Cable. Polk Audio, 1205 South Carey Street, Baltimore, MD 21230.
  - d. Ultra High Definition Speaker Cable. Audio Source, 1185 Chess Drive, Foster City, CA 94404.
2. Hiraga, Jean, "Can We Hear Connecting Wires?", Hi Fi News and Record Review, August 1977.
3. Retsoff, Alexander, "Retsoff's Remedies ," Stereo, Fall, 1978.
4. Klipsch, Paul, "Speaker Wire," Dope From Hope, Sept. 13, 1978.
5. Pass, Nelson, "Loudspeaker Damping," Audio Magazine,
6. Gailus, Mark, "Speaker Wire: What Size is Sufficient?", Audio Forum, Aug.-Sept.,
7. Greinier, R. A., "Another Look At Speaker Cables," Speaker, The Boston Audio Society, Dec. 1978.
8. Gross, T. A. G., "Multistrand Litz Wire Adds "Skin" To Cut AC Losses in Switching Power Supplies," Electronic Design, Feb. 1, 1979.

# Ecosse

## FAQ - Technical Guide

### Monocrystal:

MONOCRYSTAL™ pure copper and silver is Ecosse's pioneering commitment to conductor material development ensuring, uniquely, a complete lack of 'grain-boundaries' in the signal transmission direction - impurities which would normally impede the delicate audio or video signals and result in attenuation and distortion.

Here, a unique casting process (extrusion and annealing) is employed to produce a 'mono' or single crystal ultra-pure wire with significant advantages over other cables currently available. These other cables use ordinary copper or silver, which, no matter how few grains the manufacturer claims, have a grain barrier of oxygen and hydrogen.

Monocrystal™ patented copper and silver cables are technically unsurpassed for their quality and their ability to transmit audio and video of the highest quality with minimal distortion and attenuation from grain boundaries - BECAUSE THERE ARE NO BOUNDARIES!

A thirty-day money back guarantee and an unconditional ten-year guarantee support the Company's absolute confidence in Monocrystal™ quality.

N.B. Audiophiles should note that it is the purity of 'grain structure' (not to be confused with purity of copper or silver employed - often expressed as 99.99% or better - and merely signifying the purity of the copper ingot before smelting) which defines the major characteristics in the conductors ability to transmit audiophile quality sound and video. For the record, Monocrystal™ is 7N's pure!

### UHP-OFC:

Ecosse have laid down a specification for a 'low-grain boundary' annealed oxygen free copper - so called because the molten copper is extruded and repeatedly drawn in an inert, oxygen-free environment, to improve conductivity and reduce impurities. This we term Ultra Hi Purity Copper of a magnitude of copper-purity far surpassing that of our competitors. Our UHP-OFC is no less than 99.997% pure!

### Factors Determining Cable Quality:

Cables, being the longest part of a system, act as efficient antennas, picking up or radiating electrical noise. A cable's ability to minimise unwanted noise and to accurately transfer the frequencies inherent in the audio spectrum - 20Hz-20kHz+ - impact on the performance of your system. Truly then, cables are a vital component in today's modern audio and visual systems and it is imperative that they are given the utmost consideration.

The quality of loudspeaker and interconnect cable is determined by the following:

1. The purity of the conductor material.
2. The preciseness of the cable construction
3. The quality of the insulation material

The quality and purity of conductor material provide significant improvement in performance, enhanced resolution, clear bass, image height, depth and width. Ecosse is unique in offering vastly superior Monocrystal™ copper and silver products and now multi-award winning Ultra High Purity Oxygen Free Copper.

The selection of insulation material and construction methods influences the accuracy of musical timbre and ambience.

Our interconnects employ only the finest insulation materials of either low-density foamed Polyethylene or Teflon (PTFE). Ecosse interconnects are all double and sometimes triple shielded.

For loudspeaker cable we use only twisted pairs of multi-stranded or solidcore conductors sheathed in polypropylene as these two types most effectively reduce electrostatic capacitance, proximity effect and facilitates noise rejection.

### **Choosing the right speaker cable**

Ecosse Reference Cables are designed to provide a family of sound and a straightforward upgrade path. With each loudspeaker upgrade you will experience ever - more accurate musical delivery. The timbre of the different instruments, the soundstage and musical focus will palpably improve.

For the system, which prefers increased, taut bass and clean realistic highs, simply connect the heaviest cross section cables such as CS2.3, ES2.3 or MS2.3. For systems which are bass heavy, fit a smaller cable such as CS2.2 or ES2.2.

Where extended high frequencies together with detailed mid and tight, smooth bass is a prerequisite, fit CS2.15 or MS2.15 solid conductors, (or even better US2 and US4XS Monocrystal™ Pure Solid Silver - as these may well be the very best loudspeaker cables presently available in the world). Our new ES2.3 Ultrafine 770 - strands cable successfully bridges the gap between our CS and MS ranges - a simply superb cable upgrade offering most of the benefits of ultra-pure Monocrystal™ but at a measurable saving.

**Biwiring should be used wherever possible.** Ecosse provide dedicated biwire combinations, wherein, for optimum results, we recommend solid conductors to the tweeter and heavy cross section cables to the bass connections on biwire speakers. Less expensive systems will easily benefit from the increased resolution and detail offered by our CS4.2 biwire cable but listeners should quickly move up to the audible delights offered by our quite superb hybrid solidcore/multi stranded CS4.4, or our sheathed CS2.3/2.15, ES2.2/2.15, ES2.3/2.15 and MS4.45 combinations.

### **Choosing the right interconnect:**

#### **Hi-Fi:**

Ecosse Reference Cables are designed to provide a family of sound and a straightforward interconnect upgrade path. With each interconnect upgrade unwanted 'noise' is reduced by progressively improved shielding which together with better quality termination ensures you will experience an ever - more accurate musical delivery.

Our coaxial designed interconnects: 'The Producer', and 'The Director MD2', for digital signal transmission, together with our analogue audio interconnects, 'The Composer', 'The Conductor CA1', 'The Diva', and 'The Maestro MA2', between them have garnered a clutch of industry-led awards and 5-star reviews. This has allowed us to spend more (R&D) effort in designing balanced audio interconnects - the higher spec cable preferred by discerning audiophiles.

Our extensive research has resulted in the following high quality balanced interconnects: 'The Quartet MS2', 'The Classic' and 'The Legend US1'. All function magnificently well between CD/DVD and Amp or Processor. However, their balanced symmetrical configuration also assures audiophile quality interface between pre and power amps or as turntable leads.

These symmetrical audio interconnects employ triple shielding, to offer the ultimate protection from spurious H.F. penetration (as does our video interconnect 'The Cine'). 'The Legend US1' Interconnect improves even further upon this - offering four levels of interference-reducing screening.

## Audiovisual:

For the provision of incredibly inexpensive, but very high quality solution to the transmission of audio/digital/video signals Ecosse has researched and developed a cunningly unique range of cables. Here, our multi-award winning, universally acclaimed Monocrystal™ conductor is employed for the important 'going' conductor only (to keep the cost manageable) with Oxygen Free Copper (OFC) for the 'return' conductor.

'The Composer' Audio Interconnect works on this principle as does our S-Video interconnect, and our dedicated digital interconnect - 'The Producer'. Our RGB 'Armageddon' (video only) and Composite (video+audio) Scarts also employ this low-cost hi-performance principle. (Our 'Genesis' RGB scart employs hi-performance UHP-OFC signal conductor for the 'going' conductor). Our 'Armageddon' RGB Scart combat the problems of intermodulation and electromagnetic interference, which occurs between the two different audio and video signals - it uses the highest-grade coax-video only conductors.

For SPDIF digital connection use 'The Producer' but for true audiophile quality you must audition 'The Director'. Alternatively you can choose between our deluxe and superior toslink-toslink optical digital interconnects. The latter is also available 3.5mm-toslink and 3.5-3.5mm mini. These fibre optic cables offer confirmed transmission loss of under 1 dB @1.0m.

## Biwiring:

At Ecosse we certainly advocate, whenever possible, to use biwire combinations. In a biwire configuration the cables feeding the higher frequencies (H.F.) are not affected by electromagnetic interference from the low frequency signals (L.F.), which are carried in separate conductors.

The audio signal as it moves from low to high frequencies down the conductor moves from a DC signal to an AC signal. The DC signal down the centre meets with lower resistance in a larger conductor, so big conductors give more bass. The optimum conductor size for the lowest resistance to the bass signal is about 3.0 sq mm: hence we recommend CS2, ES2.3 and MS2.3 multi-stranded. Thereafter variations in electrostatic capacitance within the conductor cause a deletion in quality.

A solid conductor has a greater occupation area for the high frequency signal (A.C.) that occupies only a few microns into the peripheral surface of the conductor - referred to as 'skin effect'. Solidcore cables such as the CS2.15 and MS2.15 are particularly effective at extending high frequencies - counteracting the deleterious consequences of 'skin-effect'. The part of the signal to which I refer is > 20kHz. That's just beyond human hearing but it's these frequencies which influence timbre and ambience and give smear free treble by intermodulating with lower frequencies.

We particularly recommend the following biwire combinations:

- a) CS2.3/CS2.15 comprising 2 separate sets of cables for optimum efficiency.
- b) CS4.4, a superb dedicated solid core + multi-stranded cable contained in a single, pliable PVC sheath.
- c) ES2.2/CS2.15 comprising 2 separate sets of cables for optimum efficiency
- d) ES2.3/CS2.15 comprising 2 separate sets of cables for optimum efficiency
- e) MS2.3/MS2.15. The ultimate biwire combination comprising 2 separate sets of cables - now referred to as MS4.45- of separate solidcore and multi-stranded cables contained in a web sheath for tidiness of installation in your system.
- f) US2/US2 comprising 2 separate sets of cables for aural nirvana

## Construction methods - loudspeaker cables:

Ecosse speaker cables are never compromised in terms of the superiority of their construction. We use the exact same construction parameters throughout our range of UHP-OFC, UFUHP-OFC or Monocrystal™ loudspeaker Cables - only the type of conductor material and the number of strands are different. We use multi-stranded and solidcore cables as only these two types- in a twisted pair configuration - effectively reduces electrostatic capacitance, proximity effect and noise.

## **a) Multi-stranded**

For CS2.2 and CS2.3, ES2.2 and ES2.3 our delicate, stranded conductors are sheathed in low-dielectric polypropylene insulation and carefully bound in a concentric and tight lay, then twisted.

With the higher spec Monocrystal™ MS2.3 cables the 2 conductors are further isolated from microphony (or external vibration) by a bed of cotton. Paper binds this rigid structure together. Twisting of the conductors is necessary to overcome the 'proximity effect' that naturally occurs when 2 conductors are close to each other.

Concentric stranded rope lay:

Concentric Lay Stranded conductors involve multiple layers of wire laid out uniformly in a longitudinal direction  $\text{D}$  with adjacent strands laid in opposite directions. These strands form a perfect circle, which stabilise the characteristic impedance, through the length of the cable, resulting in superior sound quality.

With 'rope-lay' construction the wire is pleated allowing a large X-section of cable. This is vital as large X-sections (2.00sq mm +) provide a low DC resistance for the transmission of low frequency (bass) information, (together with extended stereo width, height and depth) and a greater surface area for the transmission of high frequency signals.

(N.B above about 3.5sq mm, other factors become significant and the cable's ability to accurately transmit audio is compromised).

## **b) Solidcore**

Ecosse Reference also employ perfectly circular solidcore loudspeaker cables as these are particularly effective at extending high frequencies - counteracting the deleterious consequences of 'skin-effect'; because AC high-frequency signal tends to travel along the periphery of the conductor and it is this skin-effect which now contributes to an increase in conductor resistance. Our solidcore precision drawn wire is coated in a polypropylene extrusion of very close tolerance uniform thickness and density along its length. The positive and negative conductors are twisted with cotton bundles and wrapped in paper fibre tape before being bonded in soft PVC. This structure results in a low microphony, self-damping cable. Our CS2.15 and MS2.15 loudspeaker cables share this design.

US2 or US4XS pure Monocrystal™ Silver 'speaker' cables offer even greater advantages in clarity, tonal purity and timbral accuracy which are the greater strengths of the solidcore cables. They consist of, respectively, 6 and 10 solidcore quadruple and sextuple (!) clad conductors  $\text{D}$  offering an uncanny sense of ambience and soundstage, with greater instrument placement and resolution; vocals are clearer with real presence and natural breath tones; glare and edginess give way to a sweeter and more detailed treble. The bass does not suffer either as the optimum wire diameter has minimal DC resistance affording a tight, extended bottom end.

### **Skin Effect:**

High frequency signals tend to occupy the periphery of the conductor, due to their failure to enter the conductor centre. These frequencies do not use the entire section of the wire and consequently meet increased resistance. The occupational area for a high frequency signal is greater with a solid conductor, therefore resistance is reduced and delivery of high frequency information is improved.

### **Proximity Effect:**

When conductors are positioned in close proximity, such as they are in 'speaker' cables, the opposite currents-one going (positive) and one returning (negative), are attracted. The current flow is no longer uniform and resistance is increased.

Twisting the conductors achieves a cancelling effect and a uniform low resistance, low attenuation current flow. All Ecosse cables employ twisted pair design. Additionally, twisting also reduces

R.F.I./EMI induced 'noise'. (*c.f. attenuation = the amount of energy consumed as the signal transmits along the cable*).

The electrostatic capacitance of a cable is determined by the relative position of the conductors, the dielectric constant (mechanical properties), and the dielectric loss of the insulation. Within the audio range, the magnitude of capacitance together with the conductor resistance governs the level of attenuation of the cable. The lower the cable attenuation, the better the cable is for audio AND visual purposes.

### **Construction methods - Interconnect cables**

Interconnect may be specified as:

Balanced - Electrically identical paths for the signal.

Unbalanced - Non-identical paths for the signal.

The unbalanced type has a 'going' and 'returning' line which are not equivalent in terms of construction or electrical performance. These are 'coaxial' cables, where the shield is conductive and is employed for the return path. In general the resistance of the shield is lower than that of the conductor - hence unbalanced!

With balanced - or symmetrical - cables the two paths for the signal are electrically identical and are totally divorced for low noise. They are screened but the screen is connected at one end only to collect and drain R.F.I./EMI 'noise'. These symmetrical cables, where the conductors are positioned side-by-side, require a twisted design configuration. Here, conductor attraction ('proximity effect') is neutralised resulting in uniform, low resistance, current flow.

In each cable a conductive braided shield protects the signal conductor from electrostatically induced noise and its 2nd, double screen, rejects magnetically induced noise - ensuring no less than 95% rejection of R.F.I. (radio frequency interference). Our interconnects employ only the finest insulation materials of either low-density foamed Polyethylene (LDPE) - the foaming reduces the 'dielectric constant' thereby stabilising the frequency characteristics of the cable) or Teflon (PTFE). These dielectric insulators exhibit superior mechanical properties such as isolation to vibration and maximise signal velocity.

Ecosse Interconnects are all double and sometimes triple shielded. The first shield will protect the conductor from electrostatically induced noise (EMI) the second shield rejects (100%) R.F.I.

### **RFI:**

The atmosphere is polluted with radio frequency noise. Cables are by far the longest part of a system and therefore act as all-too-efficient antennas picking and radiating this noise. The effects of radio frequency interference at worst rob music of transparency and compromise HF performance.

### **EMI:**

Electromagnetic effects such as capacitance, inductance and resistance can be minimised by the use of high quality dielectrics. Conductance is a measure of how well two conductors are insulated from one another. Higher quality dielectrics have fewer 'free' electrons to carry electric current and so minimise conductor intermodulation.

### **Insulation:**

It is necessary to sheath two conductors with insulation in order to properly prevent a 'short-circuit'. Inevitably this involves some signal loss because all (dielectric) insulators absorb energy to a lesser or greater extent. All Ecosse cables employ the finest insulation materials of minimum dielectric loss, thus ensuring accuracy of musical timbre and ambience. Quality insulation will also reduce E.M.I., R.F.I. and 'proximity effect'.



Ecosse interconnect conductors employ (foamed) Polyethylene Dielectric or Teflon(PTFE)Insulation as these insulators exhibit superior mechanical properties (such as isolation to vibration) to maximise the signal and its transmission velocity. In certain of our cables these two dielectrics are combined within the cable's topology. Foaming reduces the dielectric constant and the dielectric loss by introducing air, thereby stabilising the frequency characteristics of the cable.

Our loudspeaker cables are sheathed in a polypropylene insulator except where the more-expensive Monocrystal™ Silver loudspeaker Cables are concerned. Here we add our patented PTFE (polytetrafluoride epoxy) ultra-low D.C. air-space dielectrics together with Cu-foil and a nylon or polyester braiding.(see [US2](#) and [US4 XS](#) loudspeaker Cable).

'The Legend' Monocrystal™Ag Interconnect similarly has a tertiary, unique, patented PTFE (polytetrafluoride epoxy) ultra-low D.C. air-space dielectric between conductors ensuring that in a high-resolution audiophile system these Monocrystal™Ultra Pure Silver loudspeaker and Interconnect Cables offer the finest sonics available anywhere and at any price.

### **Dielectric Constant:**

The dielectric constant (D.C.) of the insulation material influences the ability of the cable to deliver rhythmic, fast and uniform sound. Frequencies fluctuate according to the efficiency of the dielectric constant of the insulation employed. Reference Speaker Cables use superior quality dielectrics in order to guarantee a low dielectric loss and a stable frequency through the audio spectrum.

Poor dielectric insulation material such as PVC (which has a relatively high D.C.) causes signal loss, and reduction in signal velocity.

### **Characteristic Impedance:**

It is of fundamental importance for the transmission of high frequency and pulse signals such as those from a digital or video source, that the transmitted signals match the characteristic impedance of the cable. The correct type of cable is an asymmetrical, or co-axial, typically of 75 Ohm impedance. Monocrystal™ MV2 series for video and Monocrystal™ MD2 series for digital audio before analogue conversion. If an alternative is used, then the signal will be reflected - jittered - and the square wave signal form will be distorted, causing a roll off in high frequency information.

### **Shield Coverage:**

Cables for the purpose of interconnecting audio and visual components are provided with a conductive shield in order to protect the signal conductors from electrostatically induced noise. The higher the percentage of shield cover the better are the rejection properties. Ecosse Reference Cables provide greater than 95% shield coverage for the rejection of RFI (Radio Frequency Interference). Most Ecosse Cables are double shielded and provide 100% coverage.

Outer sheaths require to absorb mechanical and electromagnetically induced vibration and to bend with relative ease. Ecosse Reference Cables use soft PVC.

### **Electrostatic Capacitance:**

The relative position of the conductors and the dielectric constant of the insulation determine electrostatic capacity of a cable. Within the audio range, the magnitude of capacitance together with the conductor resistance governs the level of attenuation of the cable. The lower the cable attenuation, the better the cable is for audio AND visual purposes.

### **The Plugs the Star!**

As previously stated, the quality of loudspeaker and interconnect cable is determined by the purity of the conductor material, the preciseness of the cable construction, and the quality of the insulation material. However, many experts agree that the termination also influences an interconnect or

'speaker' cable's ability to transfer the delicate audio signal. We concur, and so Ecosse interconnect plugs and loudspeaker terminations are produced to the highest possible specification.

We are the only company in the world offering non-compressing RCA plugs on our premier analogue, digital and video interconnects, and grain-free Monocrystal™ plugs (RCA and XLR) in our more expensive Monocrystal<sup>®</sup> cables. We use direct gold or silver plating on the plugs to avoid corrosion.

No interconnect plug should grip a cable with a collet or grub screw action - as this type of plug (used by most-if not all-of our competitors) compresses the signal. Audiophiles should note that collet-action or grub screw plugs can sometimes compress the cable impedance as low as 25 Ohms, resulting in signal reflections which can be disastrous-particularly for digital and video signals.

For loudspeaker termination, our low-mass direct gold-plated Beryllium Copper z/x hollow bananas offer a superior contact area to common-or-garden commercially produced bananas. Alternatively, our 'TightSeal' OFC or Monocrystal™ spades (pre-terminated on our more expensive cable) can be securely attached to a screw terminal or a binding post thereby providing a superior airtight seal with no differing material barrier to the delicate signal.

### **Matching cables and run-in time:**

Appropriate cables, properly selected and dedicated to their respective interfaces, will transmit without deletion all the excitement contained in the source material

Significant improvements are possible from matching the same cable type throughout the system thus enhancing system synergy. We strongly recommend use of cables within the same grade (see [grading system](#)) cable type - interconnects and speaker cable ₤ to ensure audiophile system quality. If upgrading in stages we recommend you choose a higher graded interconnect - as opposed to 'speaker' cable - first.

These cables will improve with use and require 'running in'. Optimum results will usually be acquired after 72hrs and up to 300hrs run-in for the Monocrystal™ types.

### **Methods for handling cables**

Cables are delicate scientifically designed products.  
For optimum performance:

1. Do not wind, bundle, stretch or tightly bend.
2. Do not place the audio cable in parallel with a power cable.
3. Do not place the audio cable in parallel with ferrous constructions.
4. Do not leave one end of any cable open, and do not allow positive and negative paths to short circuit.
5. Disconnect unnecessary cables.
6. Do not try and affect a join in cables.
7. Periodically clean any oxidation from contacts.
8. Do not use in unnecessarily long lengths.
9. Always insert or remove a cable by gripping the plug - not the cable!

# XLO

## FAQ

### Q1: Why doesn't XLO use silver conductors for its cables? Isn't silver better?

A1: Although they're not all specifically voiced, this is really three questions in one:

- Why doesn't XLO use silver?
- Doesn't silver work better?
- Doesn't silver sound better?

Let's deal with them one at a time:

First of all, the question "Why doesn't XLO use silver?" is misleading because, until just recently, XLO did use silver conductors. These were the silver conductors at the very center of the "Precious Metal Composite" conductor array in XLO's least expensive speaker cables, XLO/VDO models ER-15 and ER-16.

Both of these cables used multiple layers of conducting wire, each layer of a different effective resistance, as a cheap and efficient way of controlling "skin effect phase shift". Because of its low DC resistance, silver worked very well in that application, but we would never use it in any of our better cables.

Which brings us to the second part of the question "Doesn't silver work better?". Many people think that because of silver's low resistance (it has the lowest internal resistance of any natural metal) it ought to be more conductive than other metals. They also think that its presumed better conductivity ought to make for better cables. In fact, that's just not the case.

For one thing, in an audio or video application, silver isn't consistently more conductive than copper. Conductivity is the ability to pass a current. For a DC current, conductivity is exactly the opposite of resistance, and if we were dealing with DC, silver's lower DC resistance (it's 11% less resistive to DC current flow than copper) really would make it a better conductor. Music or video signals aren't DC, though, they're AC, and that makes a huge difference!

With AC currents, inductance becomes an important consideration. Silver is inherently more inductive than copper, and, when an AC current is passed through it, its greater inductive reactance creates a steeper AC resistivity gradient between the center and outside of a silver conductor than would be the case in a copper conductor of exactly the same physical characteristics. This results in, among other things, significantly higher "skin effect" phase shift as compared to a copper conductor, and it is an important contributor to the characteristic "silvery" sound of most silver-conductor cables.

If the issue were just resistance, it would be easy to make silver and copper cables equal: Copper has 11% more (DC) resistance than silver, so just using copper cables that are 11% shorter would make the resistance exactly the same. The fact, though, is that resistance simply isn't the issue!

Another thing that isn't the issue is cost. People sometimes assume that because silver coins are generally more valuable than pennies, silver must be more expensive than copper. That's not necessarily true: While ETP copper (the stuff that pennies and household electrical cables are made out of) is certainly cheaper than silver (at about \$0.68 as compared to \$4.65 per ounce), Laboratory Grade copper (the specially processed high-purity copper specified by XLO for use in all Reference2, Signature2, UnLimited Edition and Limited Edition cables) currently sells for as much as \$12.21 per ounce. This is more than 2 ½ times the price of silver, so if silver really were any better than copper, we would rush to use it.

Which brings us finally to the question of "Doesn't silver sound better?" We don't think so, but that's because we don't think that cables should have any sound at all!

Even people who like silver cables agree that they have their own characteristic sound. Silver cables tend to give everything that passes through them a "shiny" or "silvery" quality that might be quite seductive, but that's NOT part of the music or the sound that's actually on the recording. That isn't what XLO is all about. We believe that cables should just pass signal from one point to another, without adding, subtracting, distorting, coloring, or in any other way imposing their own voice on what you hear - even if the change are, as with silver's characteristic coloration, something that some people might like better.

"Hi-Fi" is a contraction for "High Fidelity", a term which originally referred to a philosophy of sound recording and reproduction that held to "a high degree of fidelity (faithfulness) to the actual sound of the original music. That's still what XLO believes in, and that's why we don't use silver in our cables.

## **Q2: How long can I run my speaker cables?**

**A2:** In most cases, resistance and inductance are the two most important concerns when running long lengths of speaker cable. Resistance wastes amplifier power, and, if too high, can actually lower your amplifier's effective damping factor and limit its ability to control your loudspeakers' drivers. Excessive inductance can act like an audio "choke" and limit and roll off high frequency response.

Capacitance can also be a concern, with excessive capacitance limiting and "muddying" bass response. Even so, the problem of too much capacitance is less common than that of too much inductance except in certain "ribbon" (flat format) or other cables designed with consideration only for low inductance.

Resistance, inductance and capacitance are all cumulative - the longer your cables, the higher the total value for each - so the best general rule is to keep your speaker cables as short as possible.

Another general rule - especially for long runs - is to use the "biggest" (lowest numerical AWG gauge) that you can find. The bigger the cable is, the lower the resistance will be. Beware, though, of getting a speaker cable that's ONLY bigger. There are many ways to make cables bigger, and unless they are properly designed, bigger cables can have more skin-effect phase shift and actually make your speakers sound worse.

As long as good speaker cable is used, which is properly designed and of an appropriate AWG gauge, there is really no practical limit on the length that speaker cables can be run. Most homes, and even most movie theaters, simply aren't big enough to require cable runs long enough to pose a problem.

XLO speaker cables, at every price point, are all designed for optimum performance, even in the longest lengths ever likely to be required. To be sure your system always sounds as good as it can, always specify XLO!

## **Q3: Do my speaker cables both have to be exactly the same length?**

**A3:** Unlike most other manufacturers, XLO does NOT require that its speaker cables be used in equal-length pairs.

Some cables have a high resistance to current flow (thin cables, many cheap or poorly designed cables, and especially the surprisingly high-priced carbon fiber cables from a certain well-known European cable designer who really ought to know better). High resistance speaker cables can reduce your amplifier's effective damping factor and limit its ability to control your speakers' drivers. High resistance can even produce audible differences in speaker volume. If sufficiently unequal length of these cables are used, uneven speaker volume levels and inconsistent channel-to-channel driver control can alter and unbalance stereo imaging and instrument placement.

High inductance or high capacitance - both found in some speaker cables (especially those that feature flat "ribbon" construction or "magic boxes") - can act as filters or even resonant equalizers and noticeably change speaker frequency response and tonality. Where these effects are present unequally because of differences in speaker cable length, channel-to-channel tonality will be skewed, depth and detail will be lost, and stereo imaging will suffer.

Phase-shift effects in speaker cables arise not only from "skin effect", but also from resistive/capacitive (R/C) and resistive/inductive (R/L) resonances within the cables. Because these effects are cumulative with length, different cable lengths for the two stereo channels can, where these effects are significant, cause audible problems.

XLO speaker cables simply don't suffer from these problems. The result is that, to a very substantial degree, different length cables on your two stereo channels just don't matter.

Regardless of different run lengths from your amplifier, you no longer need to put up with an unsightly coil of extra, unnecessary cable behind one speaker. Even more importantly where very expensive cables are used, you no longer need to buy one cable longer than necessary just because you do need the extra length in the other. At tens or even hundreds of dollars per foot for top quality speaker cables, XLO's exclusive ability to allow you to get good sonic results from unequal length cables can amount to not just improved "WAF" (Wife Acceptance Factor) for your system, but to very real money savings, as well!

**Q4: If I need long runs of cable for my system, which is better, to use long speaker cables or long interconnects?**

**A4:** The very best thing to do is always to try to use the very shortest cables possible for every application.

Regardless of local fashion, neither the use of long interconnects and short speaker cables, nor of long speaker cables and short interconnects offers any particular advantage, and both have their associated problems: Very long interconnects can pick up hum and noise and require shielding or, where characteristic impedance is crucial (as is sometimes the case in digital or video applications) they can result in heterodyning and "dropouts." Very long speaker

cables can result in losses of signal level, high frequency roll-offs, resonant effects and loss of amplifier damping factor.

All of these things will affect the sound of your system, and should be avoided whenever possible. Try moving or rearranging your system or your listening room or re-stacking your electronics or putting them in a rack or cabinet that will allow you to bring them closer together, using shorter cables. If none of these can be done, here's our very best advice:

Choose the cable option that will cost you the very least amount of money!

It's true, at least if the cables you're using are from XLO: XLO cables are all engineered to minimize the negative effects of use in very long lengths, so just figure out which will be less expensive -- long speaker cables or long interconnects -- in the length you require, and go with that.

In doing your calculations, be sure to remember that XLO speaker cables can be ordered and used in unequal-length pairs, and that just that one thing could save you a worthwhile amount of money.

**Q5: What is the warranty on my XLO cables?**

**A5:** All XLO cables, from the very least expensive, all the way up to the Limited Edition, are warranted for the life of the product against damage or failure due to defect of manufacture. If any XLO cable ever fails because of any manufacturing-related reason, just return it to XLO and we will, at our option, either repair or replace it and return it to you absolutely free of charge.

**Q6: Do I need a special type of cable to install behind walls or construction?**

**A6:** The answer is a firm "yes", "no", and "maybe", with the key being the word being "need":

Most building codes require that any wiring that will be built into a structure must meet certain standards of fire resistance. In the United States, the normal standards are "CL-2" or "CL-3"; in

Canada, it's "FT-4"; and similar standards are in place in most parts of the world. If you're talking about having your home or office wired for sound as part of new construction, and that construction is going to have to be inspected and approved in accordance with the local code, you probably DO "need" to use cables that will comply.

If you're running your wiring as a retro-fit after the building is already up and approved, but you're still worried about possible electrical fire hazards, set your mind at ease: Interconnects are always run at low voltage and low current, so they simply aren't a concern in that way. Even speaker cables are run at low voltages (The absolute MAXIMUM most amplifiers can ever put out is around 50 Volts), so there's little danger of sparking and even the least expensive XLO cable, if intact, has insulation capable of resisting voltages VASTLY higher than it will ever see. In terms of heat resistance, too, every one of XLO's Teflon-insulated speaker cables will withstand temperatures THREE TIMES HIGHER than is required for CL-2 rating, so you DON'T "need" to worry about using them in retrofit applications.

You don't "need" special "built-in" cables from a performance standpoint, either. All of XLO's cables will sound just as good for built-in applications as they do when used conventionally, so "maybe" you ought to go to your friendly nearby XLO dealer to check them out.

#### **Q7: Why do all XLO cables have directional arrows?**

**A7:** To indicate which way the cables should be installed for proper signal flow. The arrows should always point from "source" to "load", so interconnects will have their arrows pointing from the CD player (for example) to the preamp, or from the preamp to the amplifier. Similarly, speaker cables should always be installed so that the arrows point from the amplifier or receiver to the speakers.

Because XLO's two proprietary treatments interact with the grain of the copper conductors, all XLO cables are highly directional, and all must be properly installed in order to achieve their full performance capabilities. If installed in the wrong direction, XLO cables sound harsh, bright and "forward", just the opposite of the effects that the treatments are so famous for producing.

Another very important point on the directionality of speaker cables: INSTALLING SPEAKER CABLES WITH THE WRONG LEADS TO "HOT" AND "GROUND" WILL ACTUALLY REVERSE THEIR DIRECTIONALITY AND AFFECT THEIR PERFORMANCE. IN ADDITION TO MAKING SURE THAT THE ARROWS ARE POINTING IN THE RIGHT DIRECTION, ALWAYS BE SURE THAT THE LIGHTER COLOR LEAD IS ATTACHED TO THE POSITIVE ("HOT" or RED) TERMINAL OF YOUR AMPLIFIER AND THAT THE DARKER COLOR LEAD GOES TO THE NEGATIVE ("GROUND" or BLACK) TERMINAL.

#### **Q8: How are XLO cables terminated? Why use gold plating? Why not nickel or rhodium, like some other manufacturers?**

**A8:** All XLO cables are hand terminated using connectors of XLO's own design, made from the very best materials and dielectrics to XLO's own rigorous standards. Audio interconnects feature RCA, XLR or BNC connectors. RCA, "S", "F", and BNC connectors are used for video. All connectors are non-magnetic, and feature direct gold-plated contacts. Speaker cables may be specified with "pin" connectors, "standard" (6mm) spade lugs, "large" (8mm) spade lugs, standard banana plugs, "Deltron-style" banana plugs, or Signature Series "Saf-T-Plug" non-shorting banana plugs. All spade lugs (except for the Limited Edition) are made from CDA alloy 101 "four nines" (99.994% pure) copper, and (except where bare copper is specified), all are direct gold plated, with no intervening layer of nickel to spoil the sound.

We use gold plating just for cosmetics and to keep the connectors' substrate metal from oxidizing or corroding. Perhaps surprisingly, gold is neither particularly good-sounding nor a particularly good conductor. It's only about 40% as conductive as copper and, being highly subject to self inductance, it's NOT recommended for ultra high frequency applications.

Rhodium is another metal that some designers use for cosmetics and to prevent corrosion. Some claim that its "lattice-type" molecular structure should allow it to pass electrons more freely, but the fact

is that its conductivity is even worse than gold, and its resistance is more than ELEVEN TIMES as high as copper!

**Q9: How do XLO cables sound? Are they warm? Or bright? rolled-off or 'edgy'? What do they sound like?**

**A9:** Good questions! Many cable brands have sonic characteristics of their own that they impose on any signal that passes through them. Sometimes it's intentional, sometimes it's not, but it's never right! XLO cables are different. We believe that cables should be neutral - that they should never add anything to, or subtract anything from the signal, and that they must never distort the signal or modify it in any way.

That's XLO's design goal for every cable, and within the limits imposed by budget, materials and technology, that's what we deliver: Our very best cables, the Limited Edition come very close to this ideal of perfection, and even our least expensive cables have far less of a noticeable sonic "signature" than any of their competition. So what do XLO cables sound like? The higher you go up the XLO line, the less you hear of the cables, and the more you hear of the sound of the music, the recording, and the sound of your other components. Even at the very lowest price points, you hear more of what's actually there than with any other brand. Isn't that exactly what you want?

**Q10: Does bi-wiring really sound better?**

**A10:** Maybe. Here's the story: In order to make their products bi-wireable, speaker manufacturers have to separate the "high-pass" and "low-pass" elements of the crossover. Then, once they've done this, they have to do something to connect the two elements back together, in case the customer doesn't want to bi-wire them. To make this connection, they generally use a pair of stamped brass straps running between the two sets of binding posts that the speakers had to get in order to make them bi-wireable. What they don't seem to realize is that brass, among other nasty characteristics, has only about 20 percent of the conductivity of copper, and that those jumpers can hurt the sound of the speaker if it is used wired normally.

XLO believes that much or all of the improvement that seems to come from bi-wiring may actually come about just from removing those awful brass straps. To that end, XLO offers jumpers made of genuine VDO, Ultra, Reference2, Signature 2, UnLimited Edition and Limited Edition speaker cable with either spade lugs (large or small) or banana plugs. In most cases (except where [as we recommend] two different "special" cables, such as the combination ER-14 and ER-12 are used for special purposes), we believe that jumpers sound every bit as good as bi-wiring, and that using them can save audiophiles a whole lot of money!

One thing that we know for certain about bi-wiring is that CABLES NOT INTENDED TO BE INTERNALLY BI-WIRED ("internal" bi-wiring is making a "bi-wire" set of conductors out of a single cable) MUST NEVER BE USED IN THAT WAY: Each time a conductor element is halved (as is done in internally bi-wiring a cable not designed for that purpose), its resistance is doubled; its (AWG) gauge is reduced by three full sizes; and its original conductor geometry (which presumably was an important part of its design) is lost completely. IN NUMEROUS TESTS, INVOLVING CABLES FROM MANY DIFFERENT MANUFACTURERS, WE HAVE NEVER HEARD A WRONGLY BI-WIRED CABLE THAT SOUNDED EVEN AS GOOD AS THE SAME CABLE USED AS IT WAS INTENDED TO BE.

**Q11: How long can I run an S-video cable?**

**A11:** NO cable manufacturer - not even XLO - recommends using S-video for runs of more than 5 meters (16.4 feet)

That's NOT to say that it can't be done -- some of XLO's customers have reported successfully using XLO/VDO model ER-1s S-video cables for runs of as much as 80 feet (!) -- What we DO say, though, is that it can't be done with any degree of certainty: Among the problems that can arise from using long runs of ANY S-video cable is that "standing waves" can develop along the length of the cable. These are exactly like acoustical standing waves, and come about as a result of characteristic impedance mis-matches between the two pieces of equipment and the cable. If the length of cable you're using is at or near the standing wave peak-to-peak distance (which will vary with the length of the cable and the amount and frequency of reflected energy), you'll have problems, like bars or

diamond patterns on the screen. Going either longer or shorter MIGHT solve this: As with acoustical standing waves, if you're between the wave peaks, everything appears normal and transmission could be completely unhindered.

#### **Q12: Dielectrics? What are they, and what difference do they make?**

**A12:** To answer that, let's first ask a different question: Do you know what a capacitor is? Sure you do: It's an energy storage device that's formed when any two electrical conductors (the "plates") are separated by any non-conductor (the "dielectric"). "Charging" the capacitor is done by passing current (of either positive or negative polarity) through the conductors. This results in some of the (signal) energy being picked up and stored in the dielectric and then dumped back (INTO THE SIGNAL PATH!) when the polarity of the current changes. In a cable, the dielectric is the insulating material surrounding and separating the conductors, and just like the dielectric in a capacitor, it will pick up some of the signal energy passed through the cable and dump it back into the signal path (ALWAYS OUT OF PHASE) when the signal polarity changes. This storage and subsequent dumping of signal energy changes the signal, and therefore the sound of the entire system.

Poor quality or poorly chosen cable dielectrics are often the reason why cables have a distinct "sonic signature" when, really, they should have no sound of their own at all! For minimum sonic effect, the dielectric in a cable must store as little energy as possible. (It must have a low "dielectric constant.") and it must return its stored energy to the system in the smallest possible increment of time. (It must have a high "dump rate.") DuPont Teflon has the lowest dielectric constant and the quickest dump rate of any wire insulation material now available, and it or Teflon variants are the only dielectric or jacketing materials used in any XLO/Ultra brand, Reference2, Signature 2, UnLimited Edition or Limited Edition cable.

The ethylene polymers and co-polymers used in XLO/VDO brand cables (including proprietary products like Elvax, Surlyn and Alathon) are the next best thing to Teflon. These, while much less expensive than Teflon, also have excellent dielectric properties and can offer outstanding cable performance.

The lowest performance dielectric materials are PVC compounds, thermoplastic rubbers and nylon. These are cheap, easy to use, and tend to have a nice texture or "feel". While many other manufacturers (including some "High-End" brands) make extensive use of these materials, XLO will only use PVC for outer jacketing on its lowest cost cables, and uses none of the other materials for any purpose at all.

#### **Q13: "XLO sure does have a lot of cables! How do you tell them all apart?"**

**A13:** The first way to tell one XLO cable from another is by color: Yellow is the official color that the industry has adopted for video cables, so most XLO/VDO cables have yellow on them somewhere, and ALL VDO packaging has YELLOW as part of its color scheme. For XLO's High-End cables - Ultra, Reference2, Signature 2, UnLimited Edition and Limited Edition -- the color is PURPLE. See? You're already starting to become an XLO expert!

XLO's product numbering system is just as easy as its colors: For every product line EXCEPT VDO, all of the numbering follows exactly the same pattern:

- 1 = Unbalanced interconnects (e.g. Ultra 1, Signature 1.2, etc.)
- 2 = Balanced interconnects (e.g. Ultra 2, Signature 2.2, etc.)
- 3 = Phono cables (e.g. Reference2 Type 3a, Signature 3.2)
- 4 = Digital cables (e.g. Ref2 Type 4a, Signature 4.2, etc.)
- 5 & 6 = Speaker cables (Ultra 6, Signature 5.2, etc.)
- 10 = Power cords (ER-10, Reference2 Type 10a, Signature 2 S2/10)
- 12 = Double run speaker cables (ER-12 and Ultra 12)



**Q14: Why aren't XLO's best cables shielded except as a "special-order" option?**

**A14:** Because SHIELDING AFFECTS THE SOUND. Even shielding done the right way (which is the only way that XLO will ever do it) acts like an additional capacitor, and creates "dump artifacts" that will audibly change the sound of the system. Done the way XLO does it (with insulated overshielding spaced as far as possible from the signal conductors and grounded outside the signal path) the sonic effect of shielding is minimal. Even so, to the critical listener, it may still be audible, if only very slightly. XLO recommends that, for the very finest systems, shielding for line level interconnects should not be used unless severe EMI or RFI problems make it necessary. If you must use it, though, USE IT. It's far better to deal with tiny incremental shielding losses than with large annoying hum, noise and static problems. The proof? All of XLO's phono cables (even the Signature 2 Type 3.2) are shielded, and the critics still regard them as "The Best in the World."

**Q15: Why does XLO use braided copper and foil shielding? Why two layers? Why those two materials?**

**A15:** By now you should know that, because cable shielding always affects the signal being transmitted, it's always XLO's preference not to use any shielding at all unless it's absolutely necessary. When it IS necessary, though, we DO use it, and we insist that what we use must be the very best available. That's why, for the most critical applications, we choose both copper and foil shielding.

There are three reasons for this:

- o Coverage
- o Metal content
- o Coverage bandwidth

Braided shields cannot by themselves ever offer consistent complete coverage of the conductors to be shielded. Braiding always leaves gap areas next to the points where the braided wires cross, and even "served" shielding, which can be applied so that it initially offers 100% coverage will spread apart and develop gaps at the point opposite the point of greatest flexure whenever the shielded cable is bent. Foil shielding has no such coverage restriction, and can be applied so that it provides and maintains 100% shield coverage. Although 100% shield coverage is not necessary in all applications, where it is required, XLO always uses at least one layer of foil.

If you remember that shielding only works when it is grounded, you'll understand that "impedance to ground" is an important consideration in every shielded cable design. The object is to get the lowest possible impedance to ground so that even the lowest-level current can be effectively grounded. (The lower the level of signal that can be grounded, the more effective the shield will be.) An important element of impedance is resistance, and the more metal is in the ground path, the lower the resistance - and therefore the total impedance -- will be. Lowering impedance to ground is one of the most important reasons for ALL multi-layer shielding, and using both copper braid and foil shielding puts that much more metal in the ground path.

The currents that are sent to ground from the shield are the result of induction from the collapse of electromagnetic hum and noise fields surrounding the shielded cables. Different shielding materials have different induction characteristics and different sensitivities to the induction of current flow at different frequencies. Copper has its best sensitivity to current induction at one range of frequencies and aluminum has its best sensitivity at a different, but partially overlapping, range of frequencies. By using both copper and aluminum in our foil and braid shields, we ensure that our cables will have the broadest possible bandwidth of protection.

**Q16: What is XLO's "Field-balanced" Geometry, and what's so good about it?**

**A16:** It's the only cable geometry in the industry that actually recognizes and takes advantage of the physics of cable operation.

Whenever current is passed through a wire, an electromagnetic field is formed around the conductor. When the current-carrying wire is insulated, an electrostatic field is also formed around the insulation. Both of these fields - the current-controlled electromagnetic field and the voltage-controlled electrostatic field affect the passage of signal information, and can have a significant effect on the

sound of an audio cable. Many cable designers have tried to deal with one or the other of these field phenomena (usually the electromagnetic field), but until XLO, no one had ever recognized the importance of both fields and of their interrelationship. The fact of it is that there is only one optimum relationship for the two fields, and where that is present signal transmission is materially improved.

Optimizing the relationship of the electrostatic and electromagnetic fields is what XLO's "field balanced" geometry is all about. It's also why XLO cables look different from everything else and even from each other.

This is understandable if you consider that different applications have different current-to-voltage ratios, and that voltage and current control the intensity of the different fields. Phono cables pass very tiny currents at equally tiny voltages; line-level cables pass relatively very large voltages with very little current flow; and speaker cables need to be able to pass very large currents at relatively small voltages. With different current/voltage ratios creating different relative field intensities, but only a single optimum field relationship, it's obvious that different constructions will be necessary to achieve the same point of balance, and that is exactly what XLO has produced.

XLO's High-End cables are the first to effectively deal with the physics of signal transmission. That's why they seem to sound so good. The fact, though, is that they have very little "sound" of their own at all -- what XLO users actually hear and enjoy is the sound of the music!

**Q17: Does XLO build cables in custom lengths or with custom terminations?**

**A17:** Maybe. It depends on which cables you want, how long you want them, and what kind of custom termination you need. On our lowest-priced cables we generally DON'T do custom lengths or custom terminations, just because the amount we would have to add for individually making the cables to your special order would probably be enough to make you not want them! On our better cables, though, (XLO/Ultra, Reference2, Signature 2, UnLimited Edition, Limited Edition, and even some products in the XLO/VDO and XLO/Pro lines) custom lengths and custom terminations are things that we do all the time.

If you think that you might need custom cables, the very first thing you should do is to contact your XLO dealer and tell him what your requirements are. All XLO cables are made in a wide variety of lengths and offer a wide variety of terminations AS STANDARD, so it's possible that you don't really need custom cables at all! If you do need something really special, your dealer will be able to tell you exactly what it will cost and (after he talks with us) give you a firm date when your it can be available. Give him a call! We and all of our dealers are all Audiophiles and Home theater fans, too, and we really WANT to make sure that you get exactly what you need, exactly when you have to have it!

**Q18: Which type of video cable is better?**

**A18:** There are four basic types of video cable:

- o Composite
- o S - video
- o Component
- o RGB

The composite video system is by far the most common (and the cheapest) and uses a single coaxial cable (1 single center conductor plus 1 overall shield/ground) to carry all of your TV's sound, sync, chrominance (color) and luminance (brightness) information as a single matrixed signal. Composite video cables are almost always terminated with an "F" connector at each end.

S-video separates the video signal into its chrominance and luminance elements and carries them separately in a four conductor shielded cable terminated with 4 pin "Mini-Din" connectors which, because of their ubiquitous use in this application, have come to be known as "S-video" connectors.

Component video separates the video signal differently, dividing it into its three primary color components, red, green and blue and carrying the color and brightness information for each single color in one of three single coaxial cables which make up the complete component video "set". Each of these three cables is usually terminated with a "BNC" connector.

The RGB system is named for the three primary light colors (Red, Green, Blue) and RGB cables may consist of either four or five (five is the more common) single coaxial cable elements. If four are used, each single cable carries one of Red, Green, Blue and Sync. Five element cables add another cable for Control functions. RGB cables are almost always terminated with BNC connectors

As to which is better, the first thing to determine is WHAT KIND OF CABLES ARE YOUR COMPONENTS EQUIPPED TO TAKE? Whether one is better than another makes no difference if your equipment isn't set up to use it! REMEMBER, ALSO, THAT BOTH COMPONENTS TO BE HOOKED-UP WITH A PARTICULAR CABLE MUST BE SET UP FOR THAT CABLE'S SPECIFIC OPERATING SYSTEM. You CAN'T run from a (for example) composite video output to an S-video input. IT JUST WON'T WORK!

Even if you have all four systems available to you on all of your equipment, it's still not easy to determine which will be best for your particular system under your particular circumstances. Generally, ALL OTHER THINGS BEING EQUAL, RGB will be the same as or slightly better than Component Video, which will be slightly better than S-video, which will usually be a little better than Composite Video. NONE OF THESE THINGS ARE CERTAIN, HOWEVER. For long runs, Composite video may actually be better than S-video, and because of brand-to-brand and model-to-model differences, the particular execution or impedance match characteristics of any one particular system on any one particular component may be better or worse than any of the other systems on that same component. Our best suggestion is to either ask your dealer about which type of cables will work best with the equipment you have or intend to buy, or try all of the systems available to you before you make your purchase decision.

**Q19: I've read in the magazines that 75 Ohm characteristic impedance matching is important in my system and my cables. What does that mean? What IS characteristic impedance? How does it affect my System? Is it really all that crucial?**

**A19:** Video and coaxial digital signals and equipment are specified by industry agreement to have a characteristic impedance of 75 Ohms. Although "Ohms" is the quantifying unit for resistance, resistance isn't what is being referred to in this case. Because video and digital signals are always either very high frequency AC or very rapidly occurring digital pulses, they are affected not only by resistance but also by capacitive and inductive reactance. The combination product of all three of these factors is called "impedance", and impedance is to AC and pulsed signals essentially what simple resistance is to a DC current. The "characteristic" impedance of a circuit, a cable or a connector refers to its characteristics when used as a transmission line for high frequency or pulsed signals and the most important thing about characteristic impedance is not its specific value, but whether the characteristic impedances of all the elements to be used together (components, cables, connectors) match.

Matching characteristic impedances in low impedance circuits is always a good idea, and the Hi-Fi and Home Theater magazines are right when they say that a 75 Ohm source and a 75 Ohm load should always be matched to a 75 Ohm cable terminated with 75 Ohm connectors. The problem is that even components, connectors or cables that fall within the normal range of variance allowed by their specifications can still be 20% apart from each other, and XLO has actually measured input and output impedances on High End components that were claimed to be "75 Ohm" but were really as low as 3 Ohms or as high as 200.

The point of all this is that, regardless of what your equipment's claimed characteristic impedance may be, it may still be impossible to match it correctly. Does this matter? Maybe. It all depends on the frequency of the signal that you want to pass and the length of the cable that you want to pass it through.

The reason for matching characteristic impedances is that in a perfectly matched transmission line, where all of the characteristic impedances of all of the components, cables and connectors is identical, all of the signal energy that is put in at one end of the line will be passed through and come out at the other. In an IMPERFECTLY matched transmission line, though, some of the signal energy will not be passed through, but will hit a point of mismatch and be reflected (bounced) back to its source.

It's this reflected energy that creates problems. Heading back down the cable like a driver going the wrong way on a one way street, the reflected signal energy "heterodynes" (adds algebraically to form a new signal) with the energy coming in the opposite direction and produces -- just as one example - the black bars or diamond shapes that appear in the picture of a video system using mismatched components or a too-long S-video cable.

Heterodyning artifacts are "noise", in that they add something to the signal, and they can be a serious problem in a video or digital transmission system. Here's how they come about:

All reflected energy can be described by its frequency of reflection and by its relative amplitude, as compared to signal level. The frequency of reflection in a cable is easily calculated by simply dividing the length of the cable in meters into 300 million, the speed of light expressed in meters per second. Doing this, it's easy to see that the frequency of reflection in a one meter cable will be 300 megahertz ( $300,000,000 \text{ meters} / 1 = 300,000,000$ ); that the frequency of reflection in a 2 meter cable will be 150 megahertz ( $300,000,000 / 2 = 150,000,000$ ), and so on, the longer the cable, the lower the frequency of reflection.

As reflected energy passes back along the line at its frequency of reflection, that frequency adds to or subtracts from the incoming energy to create a new "beat" frequency (a heterodyne) at a frequency which is the average of the frequency of reflection and the frequency of the incoming signal.

If the frequency of the incoming signal is 5 megahertz and the frequency of reflection is 300 megahertz, the heterodyne frequency will be 152.5 megahertz:

5 megahertz  
+300 megahertz  
=305 megahertz

305 megahertz ) 2 [to get an average] = 152.5 megahertz [1st heterodyne]

If the reflected energy represents 25% of the signal energy, its amplitude will be 6dB below signal level and the heterodyne frequency will be 6dB below that, or a total of 12 dB below signal level.

The heterodyne adds noise to the signal, but it's far above the frequency of the signal information and, even it's only 12 dB below signal level, it will probably be of little consequence. That's not the end of it, though:

the new (1st) heterodyne frequency, 152.5 megahertz, will also beat against the incoming signal and will produce a second (2nd) heterodyne at 78.75 megahertz, 18dB below signal level:

152.5 MHz [1st heterodyne] + 5 MHz [video signal] = 157.5 MHz  
157.5 MHz ) 2 = 78.75 MHz [2nd heterodyne]

Similarly, the 2nd heterodyne will beat against the incoming signal to produce a 3rd heterodyne at (approx.) 42 mHz, and so on, until (you can calculate this for yourself if you want to) finally an 8th heterodyne is formed at very close to the video signal frequency, some 54dB below signal level.

Will this matter? We don't know. We doubt it, but it depends on how good your equipment is; how good your eyesight is; and how picky you are.

Remember, though, that that calculation was done using the 300 megahertz frequency of reflection of a 1 meter cable. If the cable were TEN meters long (with a frequency of reflection of only 30 megahertz) and everything else was held the same, it would only take a 4th heterodyne to get right smack into the frequency range of the incoming signal and that heterodyne, at only 30 dB below signal level would DEFINITELY make a difference.

So what does this all mean?

First of all, TRY TO KEEP YOUR DIGITAL AND VIDEO CABLES AS SHORT AS POSSIBLE.

Second, ALWAYS BUY GOOD QUALITY PRODUCTS FROM REPUTABLE MANUFACTURERS. Third, NO MATTER WHAT YOU DO, THERE'S ALWAYS THE POSSIBILITY THAT YOU'LL STILL HAVE IMPEDANCE MISMATCHES TO ONE DEGREE OR ANOTHER. Fourth, DON'T WORRY ABOUT IT. SOME MISMATCHING IS ALLOWED FOR IN THE SPECIFICATIONS FOR ALL EQUIPMENT, AND - AS LONG AS YOU KEEP YOUR CABLES AS SHORT AS POSSIBLE - A CONSIDERABLE AMOUNT OF MISMATCHING CAN BE TOLERATED WITHOUT ANY VISIBLE PROBLEMS AT ALL.